

NOTICE

ADVANTEST provides the following power cables for each country.
If there was any inconvenience on your use, please contact our subsidiaries or ADVANTEST representatives.

	Plugs	Standards/Countries	Ratings/Color/ Length	Accessory Codes
1		JIS : JAPAN	Rating :125V 7A Color :Black Length :2m	A01402 A01412
2		UL : USA CSA : CANADA	Rating :125V 7A Color :Black Length :2m	A01403 (Opt.95) A01413
3		CEE : EUROPE VDE : FRG OVE : AUSTRIA SEMKO : SWEDEN DEMKO : DENMARK KEMA : NETHERLANDS FIMKO : FINLAND NEMKO : NORWAY CEBEC : BELGIUM	Rating :250V 6A Color :Gray Length :2m	A01404 (Opt.96) A01414
4		SEV : SWITZERLAND	Rating :250V 6A Color :Gray Length :2m	A01405 (Opt.97) A01415
5		SAA : AUSTRALIA NEWZELAND	Rating :250V 6A Color :Gray Length :2m	A01406 (Opt.98)
6		BS : UK	Rating :250V 6A Color :Black Length :2m	A01407 (Opt.99) A01417

Note : "E" shows earth (ground).

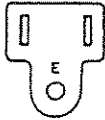
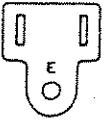
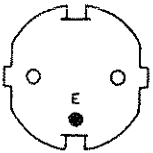
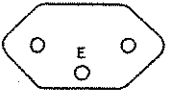
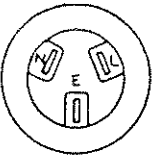
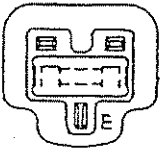

SECTION 1
GENERAL INFORMATION

1-1. GENERAL

The TR4172 Spectrum Analyzer is a microprocessor-controlled, intelligent instrument with a frequency range from 50 Hz to 1800 MHz.

In addition to the spectrum analyzing function, the integrated tracking generator of TR4172 enables analysis of frequency response of filters, amplifiers, and so on.

TR4172 is the first spectrum analyzer with a capability for measuring phase response and group delay of filters or amplifiers at resolutions of down to 0.1 deg and 0.1 ns respectively, up to a frequency of 1800 MHz.

The integrated tracking generator, along with the analyzer's intelligent control capability, permits correction of the analyzer's frequency response itself allowing precision level measurement.

A wide dynamic range is ensured by the low higher-harmonic distortion level of 90 dB at and above 20 MHz, with respect to a signal level of -40 dBm.

The display screen has a dynamic range of more than 95 dB and permits direct observation of filter responses with large attenuations.

The vertical resolution of the scale can be selected from 10, 5, 2, 1, and 0.1 dB per division. Observation of a ripple level of even 0.01 dB is possible with the maximum resolution setting.

Use of the SAVE switch makes various measurements available, with which up to eight sets of measurement condition data are stored in the internal registers and recalled as needed. Since the internal memory is backed up by a battery, its contents remain intact even if the device is unplugged from its supply outlet.

All front panel functions are remotely controllable with the GPIB interface (standard supply) for automatic measurement.

The CRT display presents all pertinent measurement data. The signal response trace and measurement data on the screen can be output to an X-Y plotter simply by connecting the instrument's GPIB connector to the plotter's input with a GPIB cable and operating the relevant front-panel switches, without the need for running an output program on the GPIB controller.

TR4172 also provides various convenient features to enhance measurement flexibility and efficiency, such as multiple marker, zoom, automatic centering, automatic enlargement, auto-peak search, logarithmic scaling, and four page memorized display.

1-2. FEATURES

- (1) Spectrum, amplitude, phase and group-delay measurement capability at resolutions of down to 10 Hz, 0.1 dB/div., 0.2 deg/div., and 0.1 ns/div. respectively.
- (2) Wide dynamic range of 90 dB at -40 dBm input level (above 20 MHz).
- (3) CRT screen with a large display dynamic range of more than 95 dB permitting direct observation of large attenuation responses.
- (4) Simultaneous four trace display allowing waveform comparison.
- (5) Multiple marker.
- (6) Automatic correction of bandwidth switching error, step amplifier switching error, and frequency response error.
- (7) Scaling the horizontal graticule divisions in logarithmic scale.
- (8) Output to an X-Y plotter supported without the need for the external GPIB controller.
- (9) Remote operation of all front panel functions via the external GPIB interface facility (standard supply).

Reading capability for measurement data and labels on the screen and writing capability for characters and data on the screen.

1-3. ACCESSORIES SUPPLIED

The standard accessories supplied with the instrument are listed below. Check the quantity and specifications of the accessories against this listing:

(1) Fuse	MDX-1A	2
(2) Fuse	MDA-1.25A	2
(3) Allen wrench	3 mm	1
(4) Input cable	MI-02 (UG-88/U plug, BNC-BNC)	2
(5) Input cable	MI-04 (UG-21D/U plug, N/H)	2
(6) Input cable	MC-61 (UG-88/U plug, BNC-BNC)	1
(7) N-BNC plug adaptor	JUG-201A/U	2
(8) BUS cable		1
(9) RF interconnecting cable		1
(10) IF interconnecting cable		1
(11) Power cable		2
(12) Instruction Manual		1

1-4. SPECIFICATIONS

(1) FREQUENCY SPECIFICATIONS

Frequency range : 50 Hz to 1800 MHz

DC coupled: 50 Hz to 1800 MHz

AC coupled: 10 kHz to 1800 MHz

Frequency span : 100 Hz to 1800 MHz on 10 divisions of the CRT horizontal axis graticule.

Enterable with the DATA knob or DATA number/unit keyboard in two significant figures.

Controllable with the DATA step keys in a 1, 2, or 5 steps.

At zero frequency span mode, the analyzer functions as a fixed tuned receiver.

Frequency span accuracy: Better than +3% for span > 500 kHz.

Better than +5% for span ≤ 500 kHz.

Center frequency : 0 Hz to 1800 MHz variable with the DATA knob, DATA step keys, or DATA keyboard.

The center frequency can also be set with the MKR → CF or SIGNAL TRACK key.

Center frequency step size can be controlled with the CF STEP SIZE or MKR/Δ → STEP SIZE key.

Center frequency accuracy: $\pm(1\%$ of frequency span + 20 Hz)

Marker

NORMAL : Provides direct frequency readout of the marker point.

Accuracy: Center frequency accuracy plus frequency span accuracy between the marker and center frequencies.

T.G. CNTR : Provides direct readout of the marker frequency.

Accuracy: Equal to the center frequency accuracy.

FREQ. CNTR : Provides direct readout of signal frequency the level of which is more than +15 dB higher than the noise level.

Accuracy: (Reference frequency accuracy) x (frequency readout) + (2 counts) for signal frequencies from 400 kHz to 1500 MHz.

Reference Oscillator Stability:

Aging Rate	1×10^{-8} /month
Long-term stability	2×10^{-8} /year
Temp Stability (0°C to 40°C)	$\pm 5 \times 10^{-9}$

SIGNAL TRACK : Maintains a drifting signal and the marker at the center of the display.

Δ(delta) : Provides direct readout of a frequency difference between two markers.

ZOOM : With use of the DATA step key $\square \downarrow$, reduces the frequency span while centering the marker.

Resolution

Resolution bandwidth (3 dB bandwidth):

10 Hz to 1 MHz in a 1-3 sequence.

Bandwidth accuracy: +20%

60/3 dB resolution bandwidth ratio:

10:1 in 1 MHz, 300 kHz

13:1 in 100 kHz to 10 Hz

Stability

Residual FM component: 2 Hz p-p/1 sec or less; frequency span < 50 kHz

Frequency stability: 30 Hz p-p/min.; frequency span < 50 kHz (at a constant temperature after 1 hour of warm-up)

Noise sideband : -75 dB or less at 20 kHz apart from the carrier, with resolution bandwidth of 1 kHz and video filter bandwidth of 1 Hz.

-80 dB or less at 30 kHz apart from the carrier, with resolution bandwidth of 1 kHz and video filter bandwidth of 1 Hz.

(2) AMPLITUDE SPECIFICATIONS

Measurement range : -130 dBm to +20 dBm (INPUT 1)

-150 dBm to -30 dBm (INPUT 2)

Display range : Logarithmic scale (with respect to the reference level): 95 dB at 10 dB/div.

50 dB at 5 dB/div.

20 dB at 2 dB/div.

10 dB at 1 dB/div.

0.8 dB at 0.1 dB/div.

Linear scale (calibrated in voltage):

10%/div. of the reference level at LIN x 1

5%/div. of the reference level at LIN x 2

2%/div. of the reference level at LIN x 5

1%/div. of the reference level at LIN x 10

Linearity

Logarithmic : +0.2 dB/1 dB over 0 dB to 95 dB

Max. +1 dB over 0 dB to 95 dB (20°C to 30°C)

Max. +1.5 dB over 0 dB to 95 dB (0°C to 40°C)

Linear : +3% of the reference level

Reference level

Reference level readout:

Logarithmic:

+50.0 dBm to -90.0 dBm (readout in units
dB μ V)

Linear: 70.7 V to 7.07 μ V

Reference level readout accuracy: Max. +1 dB after calibration and
error correction

Calibration output accuracy: -20 dBm +0.3 dB (Guaranteed at the CAL.
OUT. connector)

(50 MHz) + (50 MHz x reference oscillator accuracy)

Frequency response: Within +0.7 dB over 400 kHz to 1800 MHz (after
error correction)

Marker

NORMAL : Provides readout of the amplitude at an active
marker.

PEAK SEARCH : Positions the marker to the peak of the largest
signal.

NEG. PEAK SEARCH : Positions the marker to the peak of the smallest
signal

NEXT PEAK SEARCH : Positeons the marker from the peak of the largest
signal to the next largest

MKR \rightarrow REF : Brings the reference level equal to the marker
level.

Δ (delta) : Provides readout of the level difference between
two markers.

Multiple marker points: Up to 10 points

DISPLAY LINE : A horizontal display line traces amplitude readout.

Dynamic range

Spurious response : -80 dB or less at -30 dBm input with center
frequency ≥ 1 MHz

-60 dB or less at -30 dBm input with center
frequency < 1 MHz

Average noise level: INPUT 1 -130 dBm or less
INPUT 2 -150 dBm or less
at a resolution bandwidth of
10 Hz, video filter bandwidth of 1 Hz, and center
frequency of 1 MHz or above

Residual response : -100 dBm or less

Gain compression : 1 dB or less at 0 dBm input

(3) SWEEP SPECIFICATIONS

Sweep time : 50 ms to 1000 sec
100 μ s to 1000 sec at zero frequency span mode
Trigger mode : INTERNAL, LINE, EXTERNAL, VIDEO, and SINGLE

(4) INPUT SPECIFICATIONS

INPUT 1

RF input : N type connector, 50 Ω
Maximum input level: +20 dBm (Input attenuator 20 dB or more)
DC coupled: 0 VDC max.
AC coupled: +25 VDC max.

Input impedance : 50 Ω , VSWR 1.5 or less (at ATT \geq 10 dB)

INPUT 2

RF input : BNC type connector, 50 Ω
Maximum input level : -30 dBm +20 VDC max.

Frequency range : 10 MHz to 1000MHz

Amplification : 25 dB or more

Flatness : 3 dB p-p

Input impedance : 50 Ω , VSWR 1.5 or less (at ATT \geq 10 dB)

Input attenuator : 0 to 50 dB attenuation at 10 dB step

Input attenuator accuracy : +1 dB (at ATT \geq 20 dB, referenced to 10 dB)

(5) DISPLAY SECTION SPECIFICATIONS

Display : Graticule, waveform, measurement data, and label

Trace : 4 trace memories for traces A, B, A', and B'
When trace memories A and B are used, the number
of data points on the horizontal graticule is
approx. 1000, and vertical resolution is 0.1%.
When trace memories A' and B' are used, the number
of data sampling points on the horizontal
graticule is approx. 500.

Contents of the memories are displayed on the CRT at a rate independent of the analyzer sweep rate.

WRITE mode : Analyzer's response is stored and displayed for each sweep.

MAX HOLD mode : Stores and displays the maximum signal level at each horizontal point.

VIEW mode : No updating of the trace memory is made, and the stored memory data is displayed.

BLANK mode : No updating of the trace memory is made, and the trace data are not displayed on the CRT but are stored in the memory.

Trace Arithmetic

A-B → A : Trace B amplitude is subtracted from trace A and the result is written into trace A from sweep to sweep.

A ↔ B : Exchanges traces A and B, changing their relative intensities and storage memory locations. Traces A' and B' are also exchanged.

B-DL → B : Display line level is subtracted from trace B and the result is written into trace B.

NORMALIZE : Computes A-B → A, A ↔ B, and B-DL → B at a time

CRT Display

Screen size : 100 mm x 124 mm (P31 phosphor)

(6) TRACKING GENERATOR

Frequency range : 400 kHz to 1800 MHz
Output level : 0 dBm to -50 dBm at 10 dB step
Output level accuracy: Within +1 dB at center frequency of 50 MHz
Spurious : 10 kHz to 50 kHz: Less than 5 dB
 50 kHz to 1800 kHz: Less than 20 dB
Output connector : N female
Output impedance : 50 Ω , VSWR 1.5 or less (with ATT set at 10 dB or more)
Frequency response: 400 kHz to 1500 MHz: within +0.7dB
 400 kHz to 1800 kHz: within +1.0dB
 10 kHz to 1800 MHz: within +1.5dB
Other specifications are similar to those of the standard tracking oscillator.
Tracking drift : Less than 30 Hz/min, Less than 300 Hz/10 min (Option 08)
Frequency range : 10 kHz to 1800 MHz
Other specifications are similar to those of option 02.

(7) PHASE MEASUREMENT

Frequency range : 400 kHz to 1800 MHz
Range : 80^o, 40^o, 20^o, 8^o, 4^o, 2^o, 0.8^o, 0.4^o, and 0.2^o per division
Offset : Approx. +250^o
Measurement range : +180^o
Resolution : 1/10 or more of /div.
Accuracy : Better than +3% +0.25 (after calibration)
Residual phase : Less than 100^o p-p (with span set at 500 MHz or less, and input ATT. set at 10dB or more)

(8) GROUP DELAY MEASUREMENT

Frequency range : 400 kHz to 1800 MHz, 0 to 100 ms
Range : $16 \times \frac{1}{\text{frequency span}}$ to $\frac{1}{200} \times \frac{1}{\text{freq. span}}$ (sec/div.)
Measurement range : 160 ms/div. to 100 ps/div.
Resolution : $\frac{1}{50} \times \frac{1}{\text{frequency span}}$

Maximum resolution: 0.1 ns

Electrical length correction range: $8 \times \frac{3 \times 10^8}{\text{freq. span}}$ meters or more

Measurement accuracy: phase measurement accuracy + span accuracy

(9) QP (quasi peak) detection mode

Display dynamic range : 70 dB

① Frequency range : 10 kHz to 150 kHz

Charging time constant : 45 ms +20%

Discharging time constant : 500 ms +20%

Display time constant : 160 ms +20%

Selectivity : 200 Hz +20 Hz (at Bandwidth of 6 dB)

② Frequency range : 150 kHz to 300 MHz

Charging time constant : 1 ms +20%

Discharging time constant : 160 ms +20%

Display time constant : 160 ms +20%

Selectivity : 9 kHz +1 kHz (at Bandwidth of 6 dB)

③ Frequency range : 30 MHz to 1000 MHz

Charging time constant : 1 ms +20%

Discharging time constant : 550 ms +20%

Display time constant : 100 ms +20%

Selectivity : 120 kHz +20 kHz (at Bandwidth of 6 dB)

(10) Impedance measurement option

The impedance measurement option is designed for use with the impedance measurement standard accessory.

Specifications of Mainframe Options

Functions:

Smith chart display : Standard Smith chart
Mangified (x10) Smith chart
Polar coordinate display

Marker display: Provides direct readouts for VSWR, reflection coefficient, phase, normalized impedance, and equivalent inductance or capacitance.

Display circle: Displays an arbitrary circle representing a VSWR or reflection coefficient on the Smith chart.

Open/short auto correction : When an open or shorting plug is attached, amplitude or phase can be calibrated to impedance 0 points and ∞ point on a Smith chart, (recommended when the frequency span setting is 500 MHz or below).

Specifications

Smith chart scale:

Standard Smith chart : Real part: 0, 0.2, 0.5, 1, and 2
Imaginary part: 0, +0.2, +0.5, +1, +2

Magnified Smith chart: Real part: 0.9, 1.0, 1.1, and 1.2
Imaginary part: -0.1, 0, and 0.1

Polar coordinate scale:

Amplitude : 20% divisions of the fullscale
Phase : 30° division

Display resolution:

Amplitude : 1/500 of the distance between the center of the Smith chart and its fullscale
Phase : 1°
Frequency division : 1/500 of the selected frequency span (variable to 1/16)

Marker point resolution:

Amplitude : 1/500 of the distance between the center of the Smith chart and its fullscale
Phase : 1°
Frequency division : 1/500 of the selected frequency span

Marker readout resolution:

VSWR : 3 digits
Reflection coefficient : 3 digits
Phase : 1°
Normalized impedance : 3 digits
Equivalent inductance : 3 digits

Polar coordinate display resolution : 1/500 of the distance between the center and fullscale.

Polar coordinate display accuracy : True value is within a circle with a radius of 1 mm and its center placed at the displayed value.

Display circle resolution : 1/500 of the distance between the center and fullscale.

Amplitude information acquisition : From mainframe basic mode (LIN x 1)

Phase information acquisition : From mainframe basic mode 40°/div.

Amplitude setup on the Smith chart fullscale:
0.1 dB steps

Open/short auto correction range:

Amplitude correction range : Between fullscale and 70% of fullscale

Phase correction range : +180°

(11) Occupied bandwidth display

Trace data is divided into 1001 points to calculate power at each point. Two markers appear at the positions where 0.5% to the total power is determined from leftmost and from rightmost points respectively, and then frequency between two markers is displayed at the active function area on the left side of CRT.

(12) GENERAL SPECIFICATIONS

Operating temperature : 0°C to +40°C RH Less than 85%

Storage temperature : -20°C to +60°C

Power requirements : 100, 120, 220 V (+10%), 240 V (+4%, -10%);
50/60 Hz approx. 300 VA

Probe power supply : +15 V, 4-pin connector

Dimensions : Approx. 424(W) x 311(H) x 550(D)
mm

Weight : Less than 50 kg

1-5. OPTIONS AND OPTIONAL ACCESSORIES

The following options and accessories are available for the TR4172 Spectrum Analyzer. Factory options should be ordered when ordering the analyzer.

1-5-1. Options

- . X-Y recorder output (option 03: factory option)
 - X output: 0 V to approx. +5 V
 - Y output: 0 V to approx. +5 V
 - Z output: 0 V to approx. +5 V
- . Preamplifier (option 02 : factory option)
 - Frequency range : 10 MHz to 1000 MHz
 - Gain : 25 dB or more
 - Flatness : Better than +3 dB
- . (Option 09)
 - Frequency range : 10 kHz to 1000 MHz
 - Gain : 20 dB or more
 - Flatness : Better than +3 dB
- . Adjacent channel leakage power arithmetic operation software (option 06: factory option)

Trace data is divided into 1001 points to calculate power at each point. The power equivalent to the width specified by the delta marker is calculated, and the ratio of the calculation result to the total power is displayed. In addition, the power equivalent to the width specified by the delta marker is integrated, and integration trace is also displayed.
- . X-Y plotter interface (option 07: factory option)

Trace data, graticule line, and character are plotted by following three plotters in papers of size 210 mm x 295 mm.

[Applicable plotters]

Model 9872A/7470A/7225A (Manufactured by Hewlett Packard)

1-5-2. Accessories

* Photographing system

- (1) Camera (M75D) + close-up device (5R-32) + attachment (K-71R)
- (2) Camera with hood (M085D) + attachment (#85-27)

* Standard impedance measurement accessories

- (1) Directional bridge (60NF50)
- (2) Standard cable (DGM010-00150EE): 2
- (3) Open/shorting plugs for calibration (22N)
- (4) Standard 50-ohm terminator (26N50)

* TR17301 shielding material tester

Measures the effects of metals, plastics, or other shielding materials upon electric and magnetic field waves over a broad frequency range from 1 MHz to 1000 MHz.

SECTION 2
PREPARATION AND GENERAL PRECAUTIONS

2-1. INTRODUCTION

This section describes the general handling procedure for the TR4172 Spectrum Analyzer-preparation, general precautions and storage method. To ensure proper operation of the analyzer read the following instructions carefully.

2-2. UNPACKING

After unpacking, carefully inspect the instrument for any transit damage, paying special attention to the panel switches, CRT display, and terminals.

If the instrument is damaged or fails to operate properly, immediately notify your nearest ADVANTEST representative.

2-3. REPACKING FOR SHIPMENT

Should it become necessary to repack the instrument for shipment, use the original packing material or equivalent.

2-4. OPERATING ENVIRONMENT

(1) The instrument should be placed in a position where it will not be exposed to direct sunlight, corrosive gas, or excessive dust. The operating ambience should be 0°C to $+40^{\circ}\text{C}$ in temperature, and not more than 85% in relative humidity.

(2) Ventilation

The instrument uses two exhaust cooling fans. Be sure to allow a space of more than 10 cm behind the instrument for adequate ventilation. Do not place the instrument on its side or back.

(3) Although the analyzer is protected from line noise interference, the local line noise environment should be considered. If excessive noise is expected, use a line noise filter in the primary circuit.

(4) The operation site should be free of excessive vibration.

(5) The storage temperature range is from -20°C to $+60^{\circ}\text{C}$.

If the instrument is to be left unused for a long period of time, cover it with a vinyl cloth or put it in a carton for storage in a dry place where it will not be exposed to direct sunlight.

2-5. CLEANING CRT DISPLAY

Clean the surface of the CRT screen and filter at regular intervals with a soft cloth dampened with alcohol.

Never use any chemical solvent other than alcohol for cleaning.

Remove the filter in the following procedure. (Refer to Figure 2 - 1.)

- ① Remove the belt cover with a screwdriver.
- ② Remove two screws from the CRT upper panel.
- ③ Remove two screws from the CRT bezel adapter.

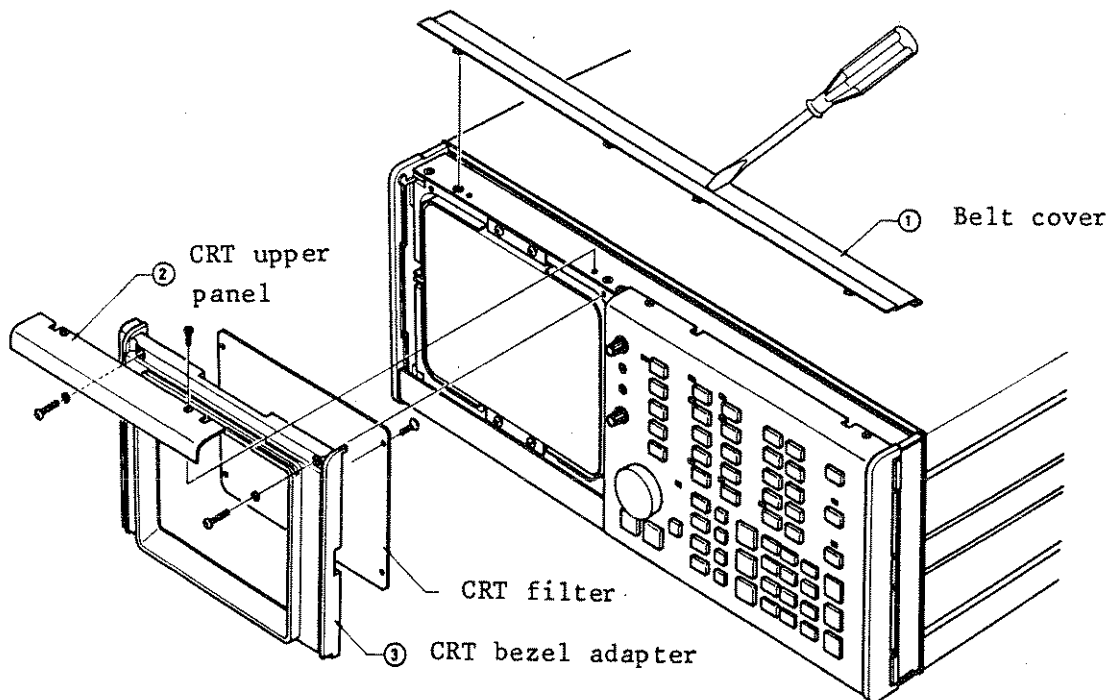

Fig. 2-1 Removal of CRT filter

2-6. PREPARATION

2-6-1. Connecting Display Section and RF Section

The analyzer consists of a display section and an RF section. Follow the procedure given below to assemble the two sections:

- ① Mount the display section (with CRT) directly on the RF section.
- ② Pull the display section forward until the joints engage with each other.
- ③ Push back the display section until the front surfaces of the two sections are aligned. Using a coin edge, fasten the two joint screws at the rear corners of the instrument.
- ④ Make electrical connections between the two sections with the three supplied interconnecting cables.

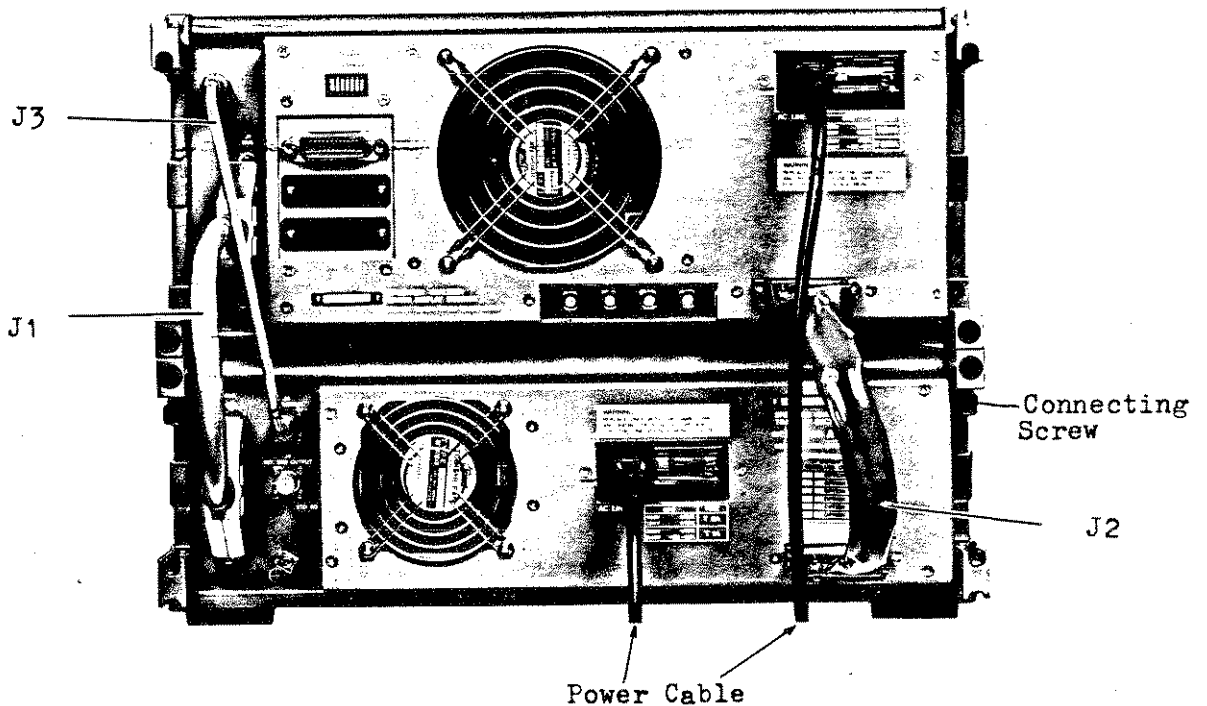

Fig. 2-2 Power and signal connections on the rear panels

- ⑤ Three signal connectors J1, J2, and J3 are provided on the rear panels of each section. Connect them with their own interconnecting cables (J1 to J1 and so forth).
- ⑥ Use the stopper and the connecting screw, when connecting J1 and J2 connectors, respectively.

2-6-2. Power Connection and Fuse

(1) Power cable connection

After establishing the signal connections between the two sections, make power connections to each section with the supplied power cables:

- ① Make sure that the POWER switch on the RF section is in the STANDBY (out) position.
- ② An AC LINE connector is provided on the rear panel of each section. Plug the female side of the supplied power cables into each of these AC LINE connectors. (See Figure 2-2.)

(2) Notes On Use of Power Cable

Before using TR4172 on commercial power, be sure to ground the equipment to prevent electric shock. Connect the concave end of the attached power cable (A01402) to the AC LINE connector. The power cable has a three-prong plug whose round prong is to be grounded.

When using a two-prong adapter to plug the power cable to a receptacle, connect the ground lead of the adapter to ground. The attached adapter A09034 (KPR-18) conforms to the Electric Appliance Regulations. As shown in Figure 2-3, prongs A and B of A09034 are different in width, so make sure which is which when plugging this adapter into a receptacle. Note that if the ground lead touches an AC line such as a power-supply terminal, the equipment may be damaged. Pay special attention when the ground lead comes close to other plugs.

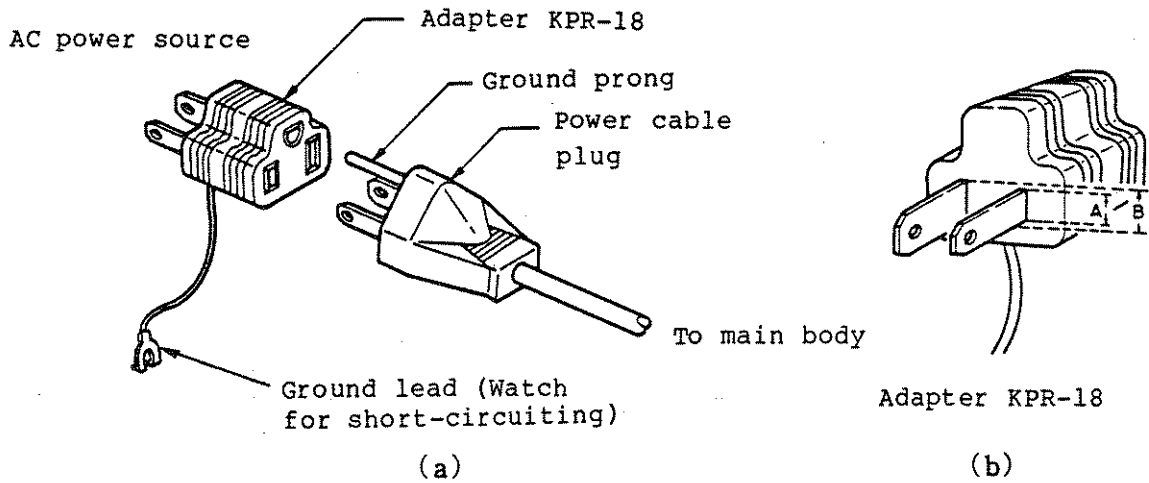

Figure 2-3 Power Cable plug and Adapter

When the instrument is plugged into an electrical outlet, the STANDBY indicator lamp on the front of the RF section will come on to indicate that the thermostatic oven for the internal master crystal oscillator is energized.

CAUTION

The instrument is partially energized even if the POWER switch is in the STANDBY position, as far as at least one of the power cables is connected to an electrical outlet. To completely turn off the instrument, be sure to disconnect both power cables from their electrical outlets.

(3) Fuse replacement

When replacing the fuse, unplug the power cable from the rear AC LINE connector of the pertinent section. Then, slide the clear plastic cover of the fuse box to the left stop. Pull the FUSE PULL lever forward to remove the fuse from the fuse box. The replacement fuse must follow the ratings of Table 2-1.

Line voltage setting can be changed by a voltage setting card inserted just below the fuse holder. When you have removed the fuse, you will see the voltage setting card just below the FUSE lever.

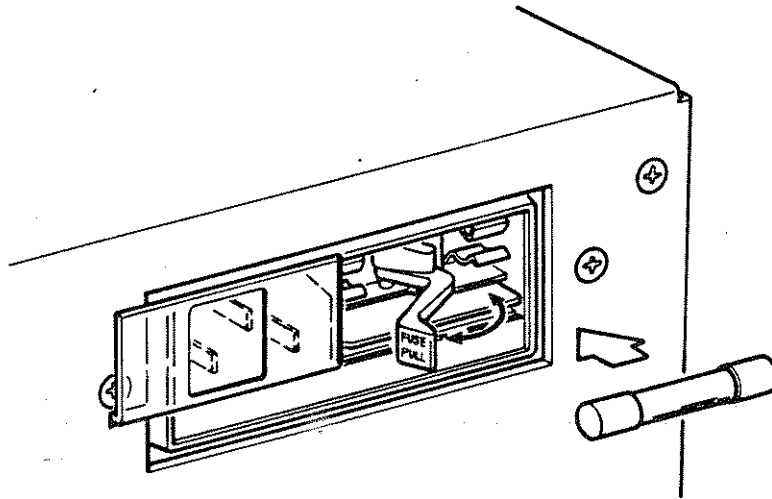

Fig. 2-4 Fuse replacement

Pull out the card and you will see voltage labels of 100 V, 120 V, 220 V, and 240 V on both sides of the card. Insert the card again into the card slot so that the voltage label corresponding to your local line voltage is on the top left side. You can see only the selected voltage label when the card is inserted in position.

The rating of the fuse to be used depends on the local line voltage. Check the fuse rating against the following table and replace it if needed:

Table 2-1 Fuse ratings versus line voltages

	Display section (upper)	RF section (lower)
AC100 V AC120 V	2.5 A slow blow	2.0 A slow blow
AC220 V AC240 V	1.25 A slow blow	1.0 A slow blow

2-7. USE OF PHOTOGRAPHIC EQUIPMENT

Assemble the close-up photographic equipment as illustrated in Figure 2-6. Photographic conditions differ depending on the setting of the INTENSITY control of the TR4172.

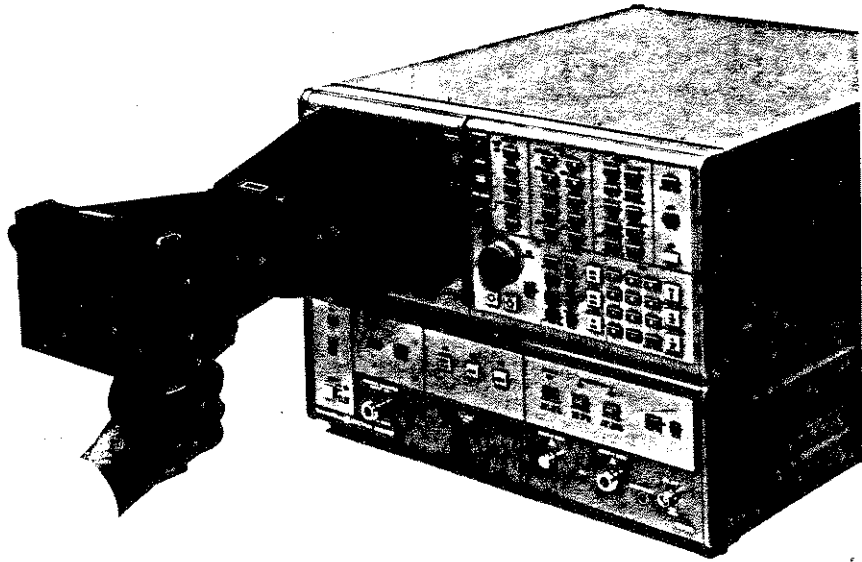

Fig. 2-5 Use of photographic equipment

Note: When the CRT display or the filter is not clear, clean photographs are not available. In this case, clean the screen and the filter referring to the subsection 2-5.

The film tends to get stuck if the roller inside the back plate becomes grimy. Take the roller out occasionally and clean it down.

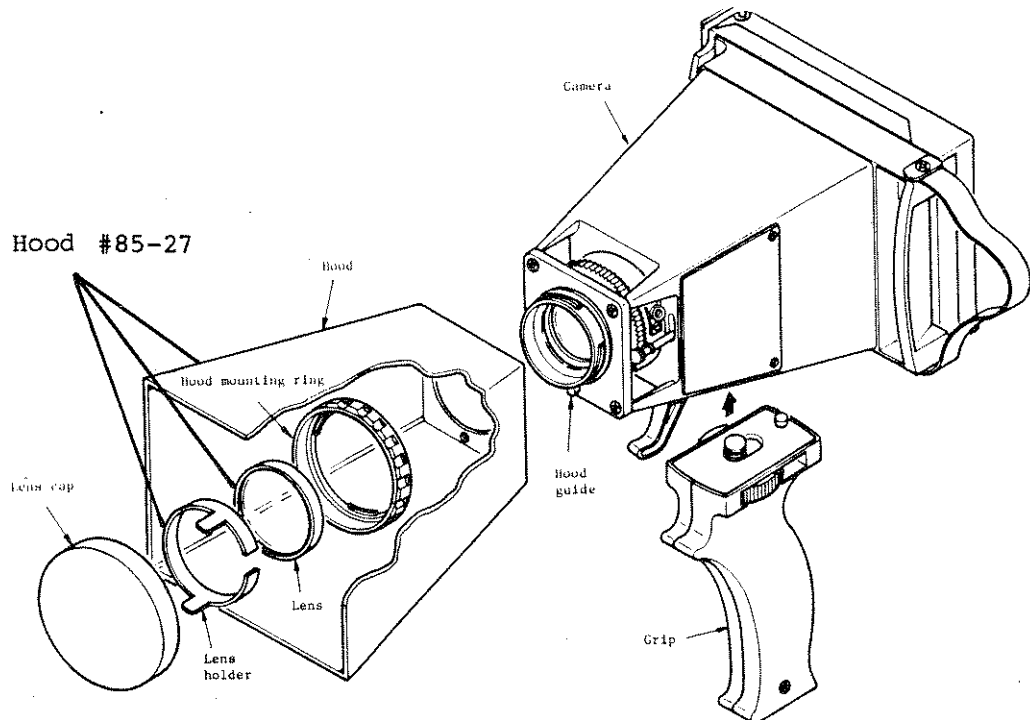

Fig. 2-6 Polaroid camera M-085D and Hood #85-27

MEMO



A large, empty rectangular area with rounded corners, enclosed by a thin black border, intended for writing the memo's content.



Section 3
PANEL DESCRIPTION

3-1. INTRODUCTION

This section first describes basic operating procedures for the TR4172 Spectrum Analyzer and then presents the functions and setting ranges of each switch and control. Each function will be discussed in detail in Section 4.

Operating details for the tracking generator, phase measurement, and group delay measurement are described in Section 5, 6, and 7 respectively.

3-2. OPERATING PROCEDURE

The analyzer's CRT display presents direct readout of the center frequency, reference level (level at the top graticule of the CRT), and so forth, as well as signal response trace and graticule display. The operation of the analyzer consists basically of setting various measurement functions with the front panel controls and key switches and observing the resulting signal response trace and data readouts on the CRT for analysis.

When the analyzer is initially switched on (POWER switch set to ON) or the MASTER RESET switch is pressed during operation, the measurement functions on the CRT display are initialized into the following state:

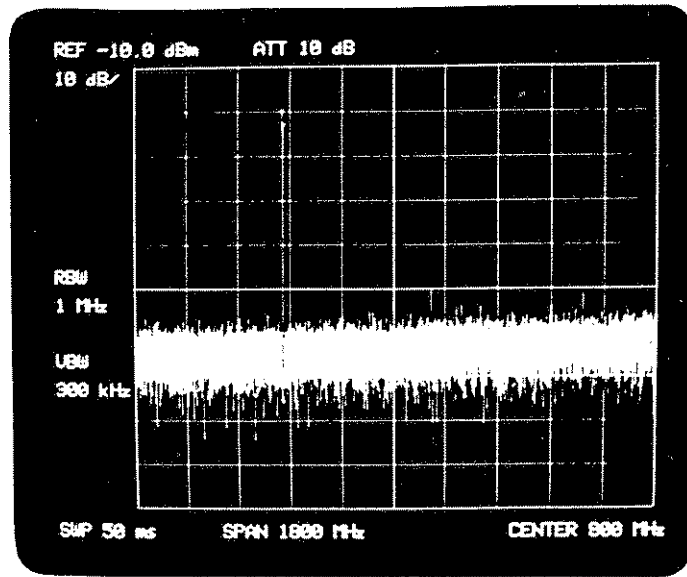





Fig. 3-1 Initial function setting upon power on or reset

To change function settings, first press the pertinent function key and then adjust the Data knob until the desired setting is obtained. The

Data step keys   or Data number/units keyboard (Data keyboard)  may be used instead of the Data knob.

For example, to move the object signal to the center of the display, first press  to activate the center frequency. The activated function is displayed to the left of the screen with enlarged readout. Since the center frequency readout is always provided at the bottom right corner of the display, there are now two identical center frequency readouts on the screen. The center frequency remains active until another function key is operated.

CENT.
FREQ.

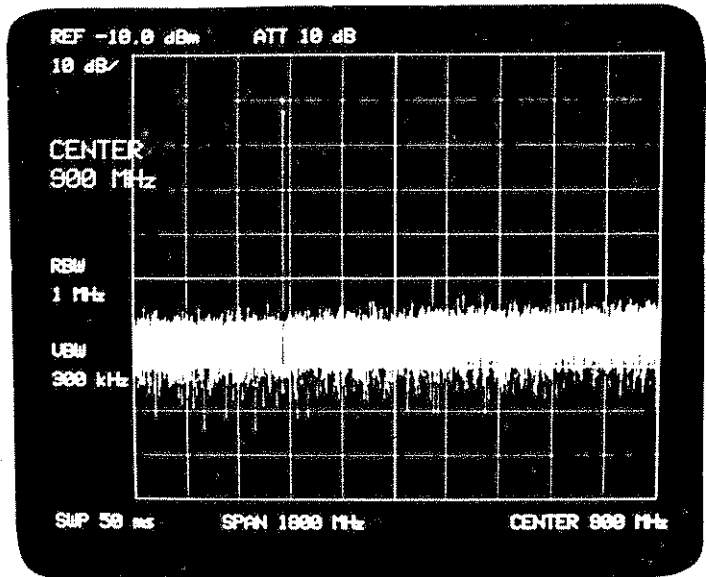

Use the Data knob to position the signal to the center of the display. For quicker control, first use the Data step keys to bring the signal to the near center, then make fine tuning with the Data knob. This practice may also be used for quick positioning of the marker (to be described later). The center frequency of the signal can now be read out.

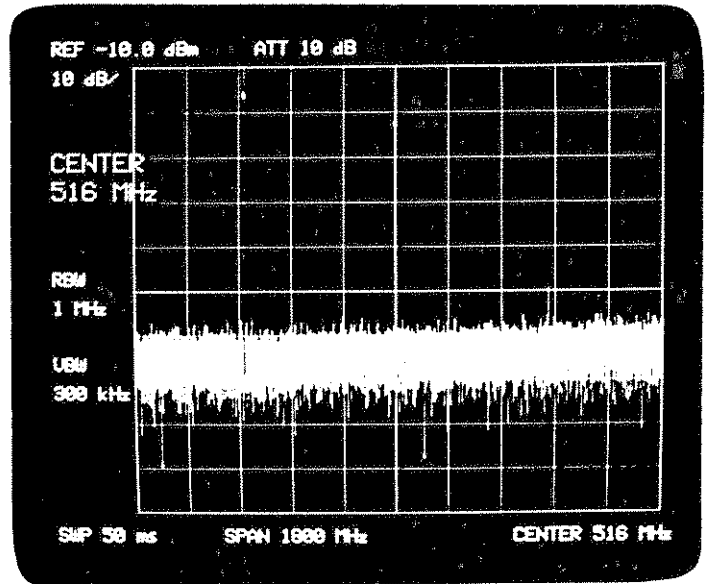
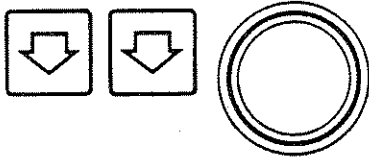

For better frequency resolution narrow the frequency span (frequency span from the left to right end of the display) with the FREQ. SPAN key and DATA control.

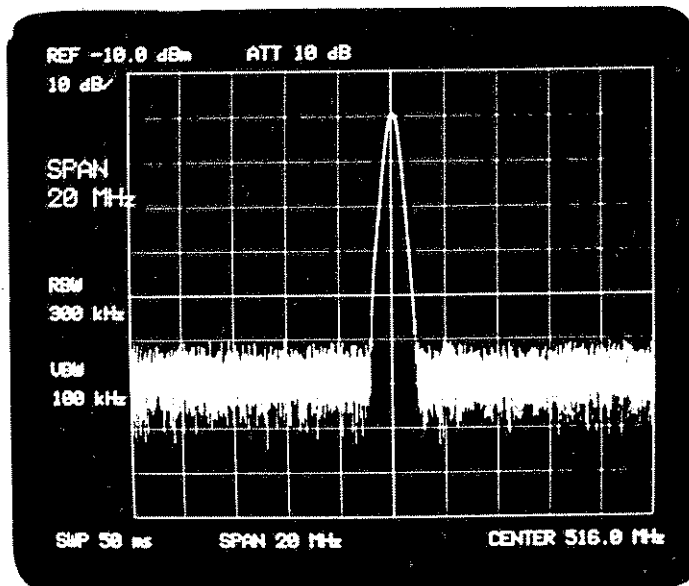
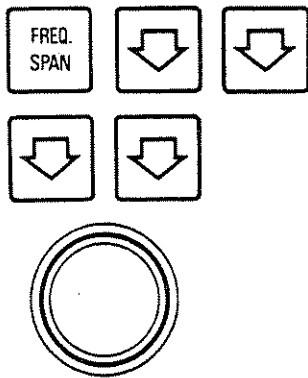

For higher signal resolution, the analyzer's IF bandwidth can be narrowed using the RES. BW. key and Data step key (down). Since the sweep time is normally set to AUTO, narrowed bandwidth causes lower sweep rate.

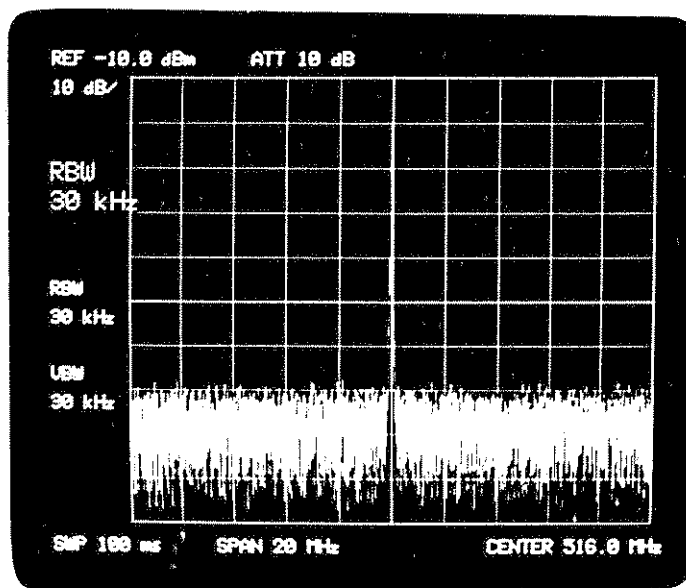
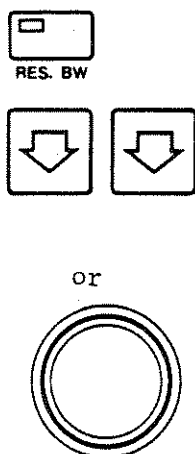

The signal frequency and level can be read out by using a marker (bright spot) without bringing the signal to the center of the display. The MARKER key activates a single marker. The marker will move on the trace with the rotation of the Data knob. Tune the marker with the Data knob to position it to the signal peak. The signal's amplitude and frequency is read out directly. While the marker is on the display the amplitude and frequency at the marker are always read at the top right corner of the display.

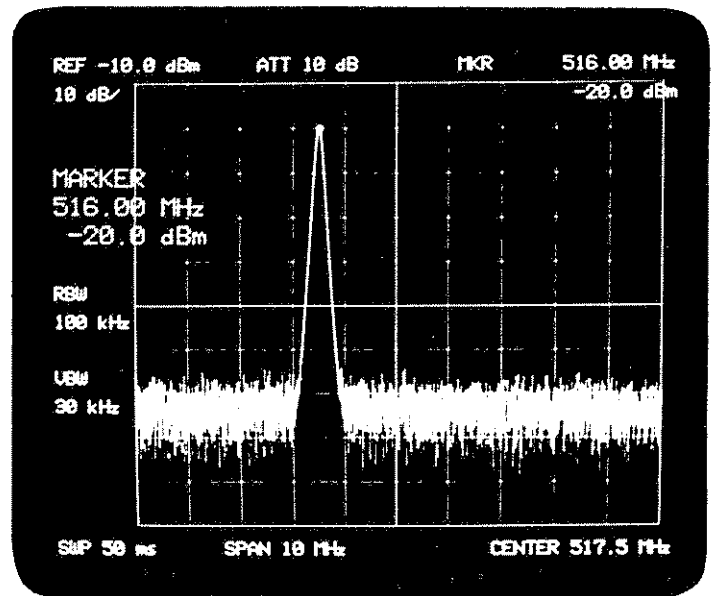
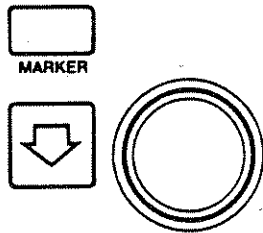

3-3. PANEL DESCRIPTION

3-3-1. Front Panel Description (See Figure 3-2.)

- (1) POWER switch
- (2) STANDBY/ON indicator lamps
The STANDBY lamp comes on when the instrument is plugged into an electrical outlet with the POWER switch set at the STANDBY (out) position. The ON lamp comes on when the POWER switch is pressed into the ON position.
- (3) MASTER RESET key
Resets the entire circuits of the analyzer into the condition shown on Table 4-2.
- (4) LCL (Local) key
Returns the analyzer from remote operation mode (by an external GPIB controller) into local operation mode (by front panel keys of the instrument).
- (5) RMT (Remote) indicator lamp
Goes on when the analyzer is in remote operation mode.
- (6) T.G. (Tracking Generator) key
Activates the output of the integrated tracking generator.
- (7) T.G. LEVEL key
Controls attenuation level for the tracking generator between 0 dB and 50 dB at 10 dB steps.
- (8) TRACKING GENERATOR OUTPUT (50 Ω) connector
The output frequency range is from 400 kHz to 1800 MHz with an output impedance of 50 Ω .
- (9) T.G. FREQ. ADJ. control
Corrects tracking error.
- (10) GROUP DELAY key
Activates group delay measurement.
- (11) PHASE key
Activates phase measurement.
- (12) NORMAL key
Returns the instrument to the normal spectrum analyzer mode.
- (13) INPUT-2 key
Selects INPUT-2: 10 MHz to 1000 MHz, max. -30 dBm, +20 Vdc.
Operatable only when the optional preamplifier is built in.

- (14) INPUT-2 connector
INPUT connector for the optional preamplifier.
- (15) INPUT-1 DC key
Selects DC coupled INPUT-1: 50 Hz to 1800 MHz, max. +20 dBm,
0 Vdc
- (16) INPUT-1 AC key
Selects AC coupled INPUT-1: 10 kHz to 1800 MHz, max. +20 dBm,
+25 Vdc
- (17) CAL. screwdriver control
Used to adjust the calibration signal level (at INPUT-1) to
-20 dBm.
- (18) INPUT-1 connector
- (19) INPUT ATT. key
Controls input attenuation level from 0 dB to 50 dB at 10 dB
steps.
- (20) AUTO key
Automatically sets input attenuation level from 10 dB to 50 dB
at 10 dB steps.
- (21) PROBE POWER connector
Four-pin connector to supply a power of +15 V to an active probe.
- (22) CAL. OUT. connector
Outputs a calibration signal of 50 MHz, -20 dBm +0.3 dB.
- (23) DATA knob
Continuously controls measurement function or marker position.
- (24), (25) DATA step keys
Steps measurement function or marker position up or down.
- (26) HOLD key
Inhibits function setting updating or entry from the DATA knob,
DATA step keys, or data keyboard. Operation of any one of the
FUNCTION keys clears the HOLD state.
- (27) ENABLE indicator lamp
Goes on when data updating or entry is enabled. Goes off when
the HOLD key is pressed.
- (28) SWEEP TIME key
Sets sweep time between 20 ms and 1000 sec.

- (29) AUTO (SWEEP TIME) switch
Automatically sets sweep time according to frequency span or RES. BW setting, etc.
- (30) RES. BW (Resolution Bandwidth) key
Sets IF bandwidth between 10 Hz and 1 MHz at 1 to 3 sequence.
- (31) AUTO (RES. BW) key
Automatically sets IF bandwidth according to frequency span.
- (32) VIDEO BW key
Sets video filter's pass bandwidth between 1 Hz to 1 MHz at 1-3 sequence.
- (33) AUTO (VIDEO BW) key
Automatically sets video bandwidth according to frequency span.
- (34) CF STEP SIZE (Center Frequency Step Size) key
Determines center frequency stepping span by the DATA step keys.
- (35) AUTO (CF STEP SIZE) key
Automatically sets the CF STEP SIZE to 1/10 of the frequency span.
- (36) CENT. FREQ. (Center Frequency) key
Sets center frequency between 0 Hz and 1800 MHz.
- (37) FREQ. SPAN (Frequency Span) key
Sets frequency span between 100 Hz and 2000 MHz.
- (38) REF. LEVEL (Reference Level) key
Sets the reference level between -90 dBm and +50 dBm.
- (39) DATA number/units keyboard
Used to enter measurement data or marker frequency directly with numerical data and units.
- (40) BACK SPACE key
Backspaces data entry steps to permit correction of entry error.
- (41) MHz dB sec/PHASE OFFSET key
One of the three unit keys. Data entry is completed by pressing a unit key after numerical data is keyed-in from the DATA keyboard. When phase measurement is active, pressing this key enables phase offset data entry.
- (42) kHz +dBm msec/G.D. OFFSET key
One of the three unit keys. When the group delay function is active, pressing this key enables group delay offset data entry. Positive reference level data can be input with this key

after the reference level data is keyed-in from the DATA keyboard.

(43) Hz -dBm μ sec key

One of the three unit keys. To enter negative reference level data, first key-in the positive level data from the DATA keyboard, then press this key.

(44) INTENSITY control

Controls intensity of all CRT display.

(45) FOCUS

A screwdriver adjustment which focuses all CRT display.

(46) TRACE ALIGN

A screwdriver adjustment which tilts all CRT display.

(47) SWEEP IND. (Sweep Indicator) lamp

Goes on during sweep.

(48) INT. (Internal) key

Automatically repeats internally-triggered sweep.

(49) LINE key

Triggers sweep start synchronously with the line frequency.

(50) EXT. (External) key

Triggers sweep start by an external trigger signal (TTL level) applied to the rear EXT. TRIG connector. Trigger occurs at HIGH to LOW transition of the external trigger signal.

(51) VIDEO key

Triggers sweep start if a detected IF signal reaches to a level set by the TRIG. LEVEL control (52).

(52) TRIG. LEVEL (Trigger Level) control

Controls trigger level for a detected video signal. If sweep fails to start when the VIDEO key is pressed, adjust this control for the adequate trigger level.

(53) SINGLE key

Each depression of this key triggers a single sweep.

Note: More detailed operations of the TRACE keys (54) to (63) will be described in Section 4-10.

(54) WRITE A key

Updates and displays trace memory A for each sweep.

- (55) WRITE B key
Updates and displays trace memory B for each sweep.
- (56) VIEW A key
Stops updating trace memory A and displays the latest signal response.
- (57) VIEW B key
Stops updating trace memory B and displays the latest signal response.
- (58) A \rightleftharpoons B key
Exchanges the contents of trace memories A and B.
- (59) B-DL \rightarrow B key
Display line level is subtracted from trace memory B contents and the result is written into trace memory B.
- (60) A-B \rightarrow A key
Trace B is subtracted from trace A for each sweep and the result is written into trace memory A.
- (61) B \rightarrow B' key
Writes trace memory B contents to trace memory B'.
- (62) VIEW A' key
Displays the contents of trace memory A'
- (63) VIEW B' key
Displays the contents of trace memory B'.
- Note: More detailed operations of the MARKER keys (64) to (73) will be described in Section 4-9.
- (64) MARKER key
Activates a single marker.
- (65) MKR OFF key
Erases all markers from the display.
- (66) Δ (delta) key
Activates two markers and provides a readout of frequency difference and level difference between the two markers.
- (67) PEAK SEARCH key
Positions the marker to the highest signal peak.
- (68) ZOOM key
Zooms in on a signal specified by a marker. Press the ZOOM key, identify the signal to be zoomed in on with the marker, then operate the Data step key (down) to narrow the frequency span.

(69) MKR → CF key

Substitutes the center frequency with a marker frequency to position the marker to the center of the display.

(70) SIGNAL TRACK key

Positions a drifting signal always at the center of the display.

(71) MKR/Δ → STEP SIZE key

Substitutes the center frequency step size with a marker frequency. In the Delta (Δ) mode the center frequency step size is given by the frequency difference between two markers.

(72) FREQ. CNTR key

Directly counts input signal frequency.

(73) MKR → REF. key

Substitutes the reference level with a marker level to position the marker on the top graticule of the display.

(74) DISPLAY LINE key

Activates a display line (horizontal cursor line).

Note: More detailed operations of the DISPLAY LINE key (74) will be described in Section 4-12.

(75) LABEL key

Permits entry of any alphanumeric characters in the top display area of the CRT screen. The entry procedure will be described in Section 4-12.

(76) SHIFT key

When pressed a first time, the analyzer enters the Shift Key mode and the functions indicated just above each key in yellow letters are made available. The Shift Key mode is cleared when any of the keys is pressed or the SHIFT key is pressed a second time.

Each key function in the Shift Key mode will be described in Section 4.

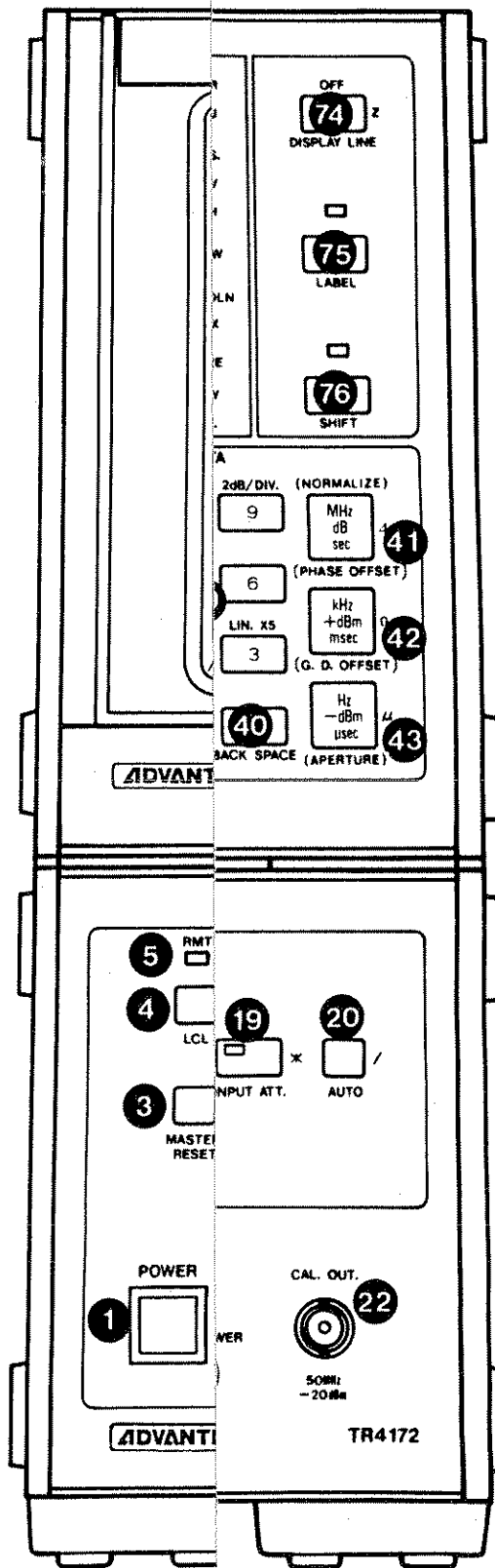
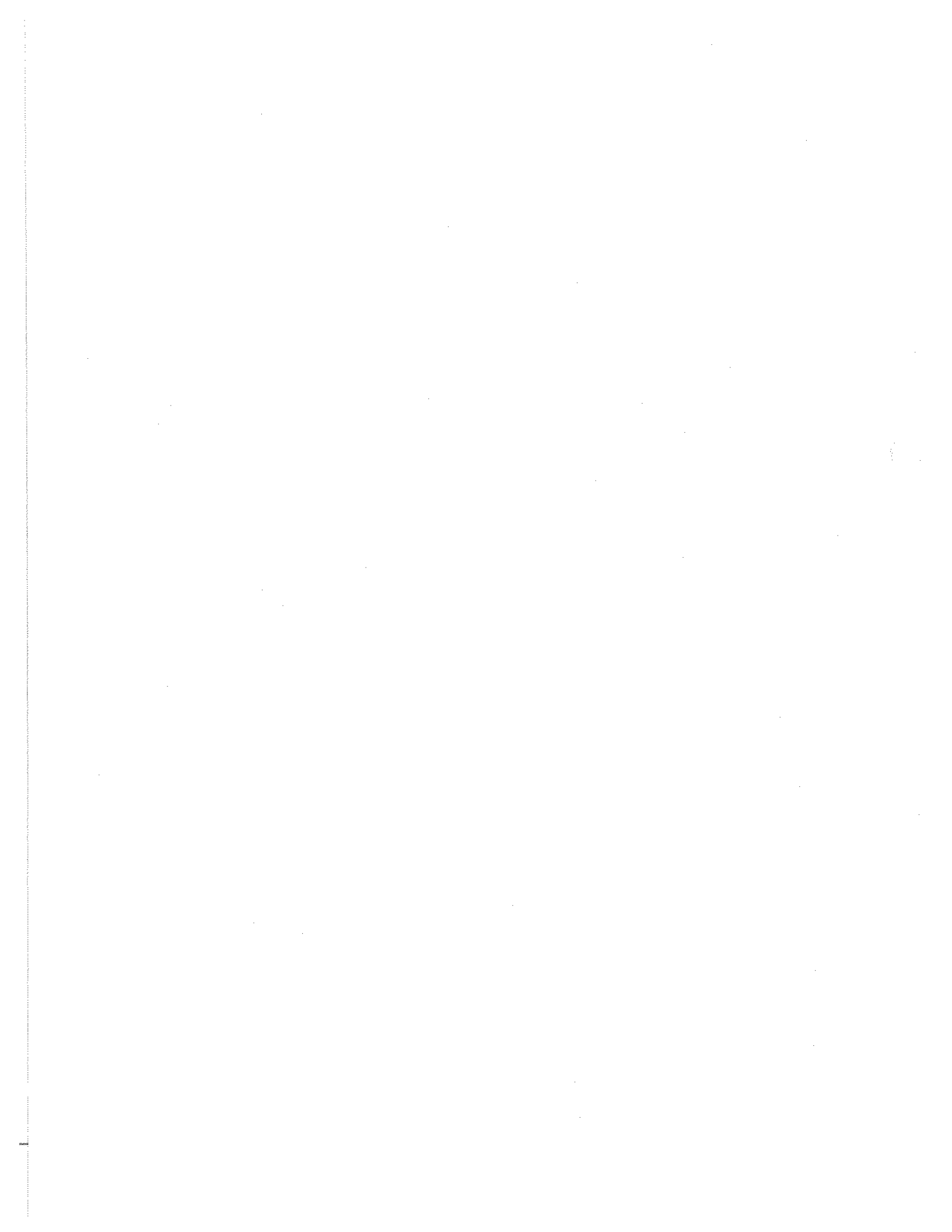

Fig. 3-2 Front panel



3-3-2. Rear Panel Description (See Figure 3-3.)

- (1) J3 IF INPUT
Accepts signal from RF section J3 IF OUTPUT (11) via the supplied cable.
- (2) J1 BUS connector
Connects to the RF section J1 BUS connector (10) via the supplied BUS cable.
- (3) Ground terminal
When a two-conductor plug adapter is used for power connection, the ground lead of the adapter or this ground terminal should be connected to the earth ground.
- (4) ADDRESS switch array
Used to designate the device address (1 to 5) of the instrument for remote operation.
- (5) GPIB connector
Accepts a GPIB cable from an external controller or X-Y plotter.
- (6) EXT. TRIG connector
Accepts an external trigger signal. When the front TRIGGER function is set to EXT. mode, the analyzer is triggered by the negative leading edge of an external TTL trigger signal.
- (7) XYZ outputs
Optional X, Y, and Z axis outputs.
- (8) J2 connector
Connects to the RF section J2 connector (15) via the supplied cable.
- (9) AC LINE connector
Accepts a power cable.
- (10) J1 BUS connector
Connects to the display section J1 BUS connector (2) via the supplied cable.
- (11) J3 IF OUTPUT
Connects to the display section J3 IF INPUT connector (1) via the supplied cable.

- (12) J4 INT. STD OUTPUT connector
 A 10 MHz internal master oscillator output (TTL compatible). This output should be adjusted to exactly 10 MHz with screwdriver adjustment STD ADJ. (13). (See Section 4-26.)
- (13) STD ADJ. volume
 A screwdriver adjustment which adjusts the output frequency of J4 INT. STD OUTPUT connector (12) to exactly 10 MHz.
- (14) Ground terminal
 When a two-conductor plug adapter is used for power connection, the ground lead of the adapter or this ground terminal should be connected to the earth ground.
- (15) J2 connector
 Connects to the display section J2 connector (8) with the supplied cable.
- (16) AC LINE connector
 Accepts a power cable.
- (17) SWEEP OUT connector
 Sweep voltage of 0 to +8 V is output from this connector.

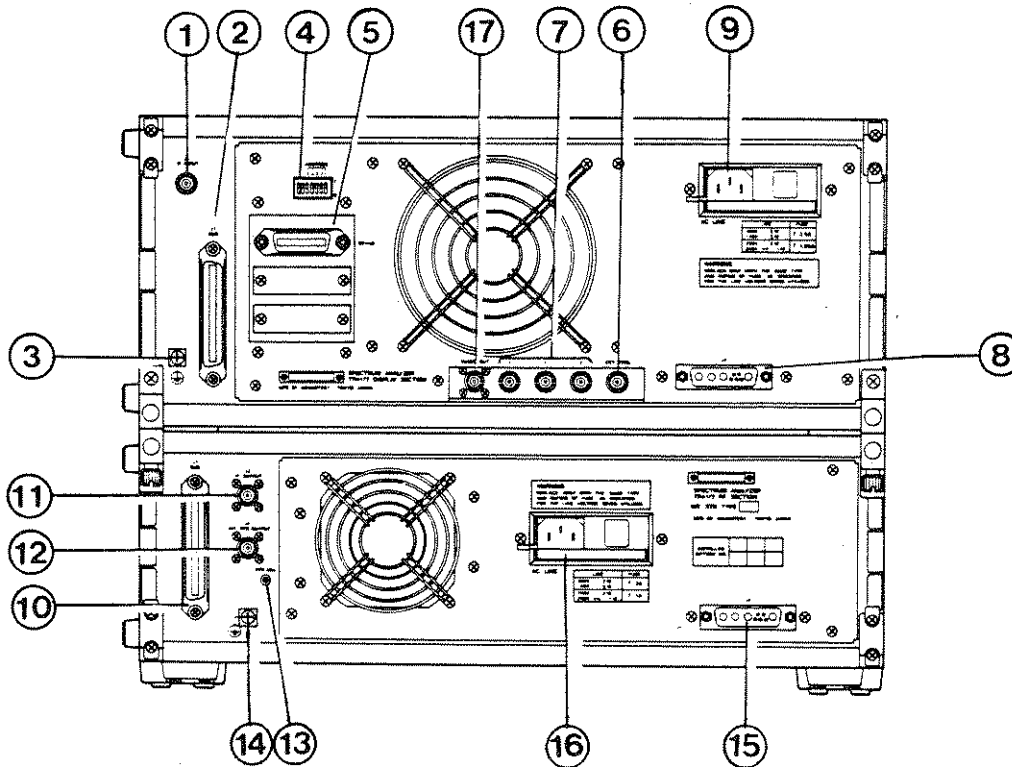

Fig. 3-3 Rear panel

SECTION 4
OPERATION

4-1. INTRODUCTION

This section describes the versatile measuring functions of the TR4172 Spectrum Analyzer in more detail.

4-2. POWER, MASTER RESET, AND LCL KEYS

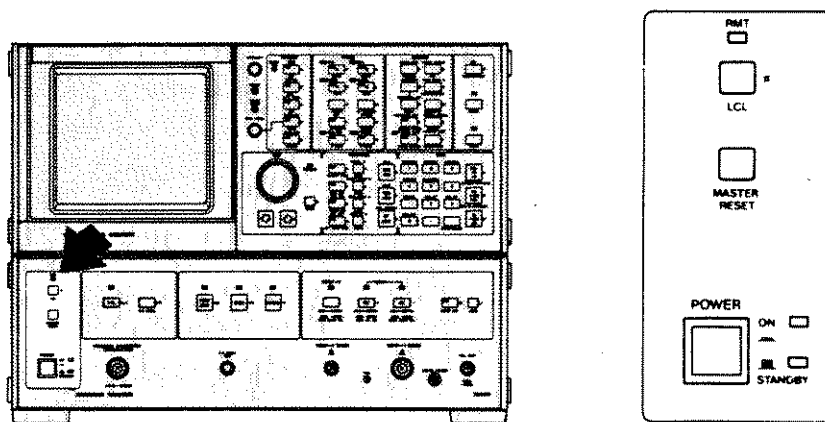

4-2-1. POWER Switch

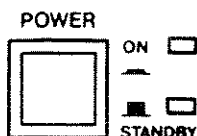

Make signal and power connections for the instrument as indicated in Figure 2-2. When a two-conductor plug adapter is used for the power connection, be sure to connect the ground lead of the adapter of the rear ground terminal of the instrument to the earth ground.

Table 4-1 POWER switch setting

Power cables unplugged	Instrument completely turned off
Power cables plugged in STANDBY	Master crystal oscillator and back-up battery are turned on.
ON	Instrument completely turned on

When the instrument is plugged into electrical outlets, the STANDBY indicator lamp lights to indicate that the internal master crystal oscillator, and back-up Ni-Cd battery are turned on. When the POWER push switch is pressed into the ON position, the ON indicator lamp lights to indicate that the instrument is completely turned on. To use the analyzer within its accuracy specifications, approximately 24 hours of warm-up time is required under the STANDBY or ON state. The internal memory contents remain intact for approximately two weeks even if the instrument is unplugged from its supply outlets, provided the back-up battery is fully charged beforehand. The Ni-Cd battery will require a charging time of two to three days. Unless the instrument is to be left unused for a prolonged period of time, it is recommended that the analyzer be left in the STANDBY state with its power cables plugged into their supply outlets.

4-2-2. MASTER RESET



When pressed, the MASTER RESET key clears the analyzer's functions to the initial state. The functions affected by the MASTER RESET key and their initial states are listed below.

The MASTER RESET key may be used if the analyzer is malfunctioning due to noise interference or other causes.

Initial States of Functions Affected by the MASTER RESET

CENT. FREQ.	900 MHz
FREQ. SPAN	1800 MHz
Reference level	-10 dBm
SWEEP TIME	AUTO (50ms)
RES. BW	AUTO (1 MHz)
VIDEO BW	AUTO (300 kHz)
CF STEP SIZE	AUTO
INPUT ATT.	AUTO (10 dB)
INPUT MODE	AC
NORMAL	ON
PHASE	OFF
GROUP DELAY	OFF
T. G.	OFF
TRIGGER	INT.

TRACE	WRITE A
	BLANK A'
	BLANK B
	BLANK B'
	Other keys OFF
MARKER	All OFF
DISPLAY LINE	OFF
LABEL	OFF
SHIFT	OFF
INT. STD OUT	OFF
dB/DIV.	10 dB/DIV.

4-2-3. LCL



The LCL (Local) key is operative when the analyzer is in remote operation mode.

When the analyzer is remotely controlled by an external GPIB controller, the RMT indicator lamp just above the LCL key lights to indicate that front panel control of the analyzer is prevented except for the MASTER RESET key operation.

When the LCL key is pressed, the RMT lamp will go off to indicate that front panel control of the analyzer is enabled. If the Local Lockout command is sent from the GPIB controller, however, the LCL key remains inoperative.

4-3. T.G., T.G. LEVEL, AND T.G. FREQ. ADJ.

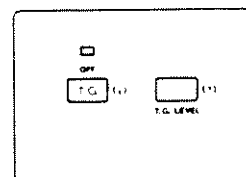
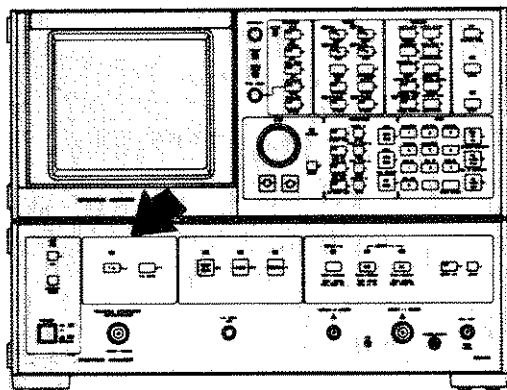

TRACKING GENERATOR OUTPUT (500)



T.G. FREQ. ADJ.



These keys are for internal tracking generator control. Press **T.G.** to activate the tracking generator; the indicator lamp just above the TG key lights.

Press **SHIFT** **T.G.** to deactivate the tracking generator; the indicator lamp goes off.

The tracking generator is used for phase or group-delay measurements as well. More detailed operations of the tracking generator, including the T.G. LEVEL and T.G. FREQ. ADJ. controls, will be described in Section 5. For normal operations of the analyzer, leave the tracking generator inactive. This will enable measurement capability at the maximum sensitivity of the instrument. When the tracking generator is activated, the analyzer's sensitivity may be degraded due to noise interference from the tracking generator.

The tracking generator is also activated when the PHASE or GROUP DELAY key is pressed. If the normal measurement mode (for spectrum analysis) is restored with the NORMAL key, the tracking generator will remain active. To deactivate the tracking generator press SHIFT, T.G..

4-4. GROUP DELAY, PHASE, AND NORMAL KEYS

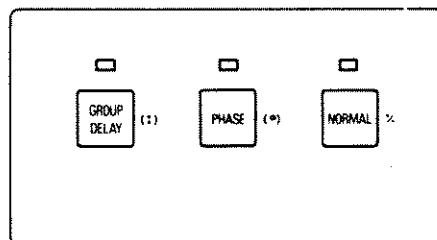
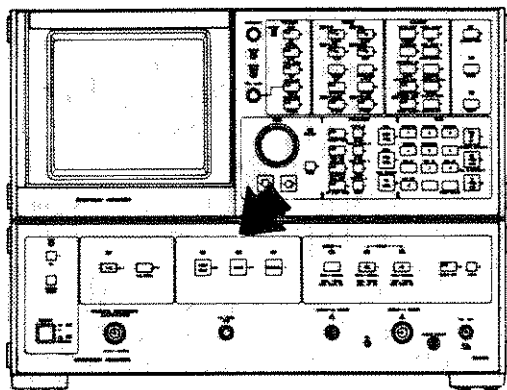

These keys select analyzer's mutually exclusive measurement modes. When one of **GROUP DELAY**, **PHASE**, and **NORMAL** is pressed the corresponding measurement mode is selected and the indicator lamp for the selected mode lights.

For details of phase measurement and group delay measurement see Section 6 and 7 respectively.

The analyzer should normally be placed in the Normal mode by pressing the NORMAL key.

Once the GROUP DELAY or PHASE measurement mode is entered by pressing the respective key, the internal tracking generator is activated and remains activated even after the analyzer is returned to the NORMAL measurement mode. When the tracking generator is unused, press SHIFT, T.G. to deactivate it.

4-5. INPUT

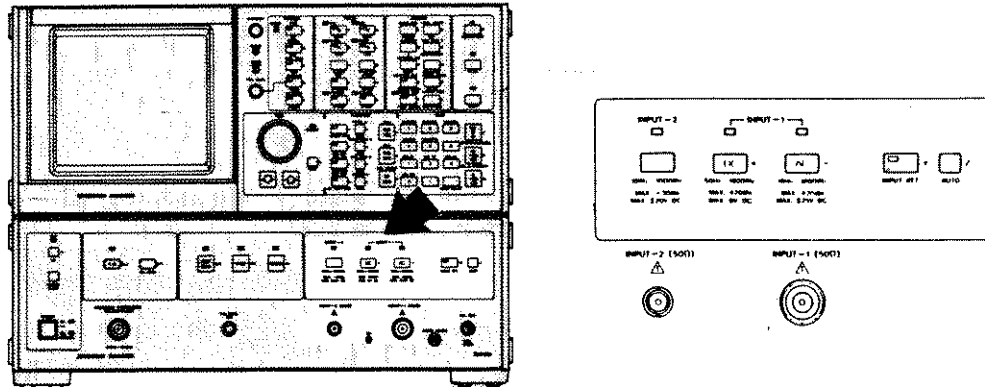

These keys are input controls and settings of RF attenuator.

4-5-1. INPUT-2

INPUT-2 is dedicated for the optional preamplifier. To select the preamplifier input press the INPUT-2 key; the indicator lamp just above the key will light to indicate that INPUT-2 is selected. When the preamplifier is not built-in, the lamp remains off even if pressed. The specifications for INPUT-2 are:

Frequency range: 10 MHz to 1000 MHz

Input impedance: 50 Ω

Maximum input level: -30 dBm, +20 Vdc

4-5-2. INPUT-1 (DC, AC)

To select INPUT-1 press DC or AC .

When DC is pressed, INPUT-1 is DC coupled to the 1st mixer to enable signal response observation over a frequency range from 50 Hz to 1800 MHz.

Never apply a DC voltage to INPUT-1 when DC mode is selected; otherwise the input circuit of the 1st mixer will be permanently damaged.

When AC is pressed INPUT-1 is AC coupled to the 1st mixer to permit signal response observation over a frequency range from 10 kHz to 1800 MHz. The maximum allowable input level is +20 dBm or +25 Vdc. When the analyzer is turned on or the MASTER RESET key is pressed, the AC mode for INPUT-1 is automatically selected.

4-5-3. INPUT ATT.



The INPUT ATT. key controls the input attenuator's attenuation level between 0 dB and 50 dB at 10 dB steps.

Normally, the input attenuator is controlled in the AUTO mode, in which the attenuation level is automatically set between 10 dB and 50 dB according to the REF. LEVEL key setting. To protect the input mixer, 0 dB attenuation is not selected when in the AUTO mode.

The currently selected attenuation level is always read at the top of the CRT display such as ATT XXdB.

When manual setting of the input attenuator is desired, press INPUT ATT. ; the key indicator lamp will come on.

The attenuation level is now active and the current attenuation level "ATT XXdB" is read to the active function display area of the CRT display. Set attenuation to the desired level with

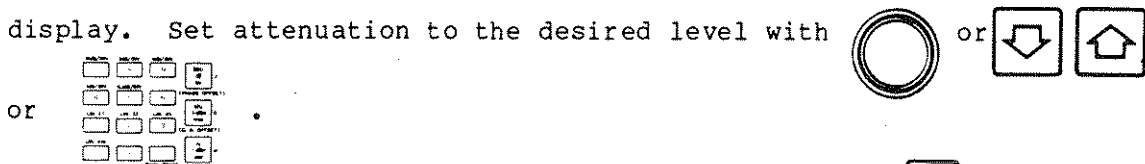

To return the attenuator to the AUTO control mode press AUTO . The key indicator lamp on INPUT ATT. will go off and the attenuator is automatically controlled according to the REF. LEVEL setting.

4-6. CRT DISPLAY

The CRT display presents the signal response trace, graticule, measurement data, and labels.

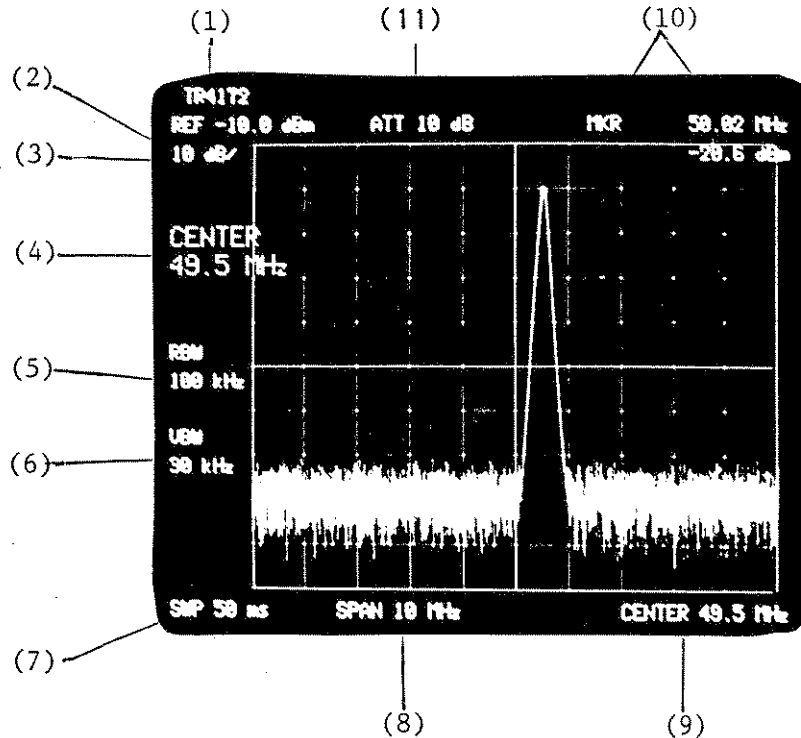

- | | | |
|------|-----------|--|
| (1) | TR4172 | Label which can be optionally written by the user (Section 4-12-2) |
| (2) | REF | Reference level (Section 4-8-3) |
| (3) | 10 dB/div | Vertical scale per division (Section 4-8-4) |
| (4) | (CENTER) | Active function (Section 4-8) |
| (5) | RBW | Resolution bandwidth (Section 4-8-6) |
| (6) | VBW | Video bandwidth (Section 4-8-7) |
| (7) | SWP | Sweep time (Section 4-8-5) |
| (8) | SPAN | Frequency span (Section 4-8-2) |
| (9) | CENTER | Center frequency (Section 4-8-1) |
| (10) | MKR | Marker (Section 4-9) |
| (11) | ATT | Input attenuator level (Section 4-5-3) |

4-7. DATA

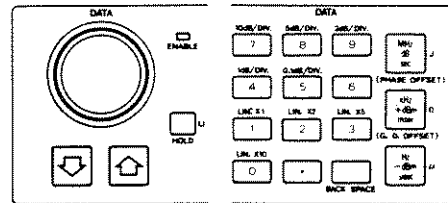
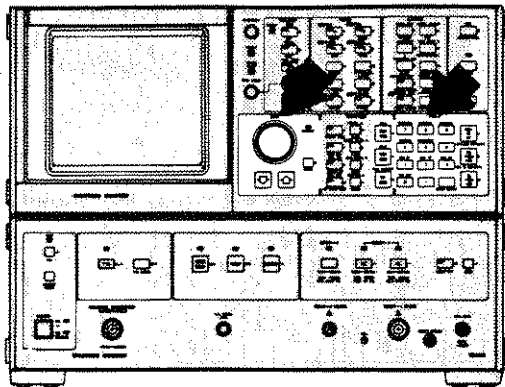

Any function can be selected by pressing the appropriate front panel function key, and changed by using any or all of the following DATA controls:



: DATA knob

: DATA step keys

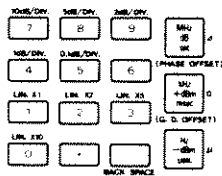

: DATA number/units keyboard (DATA keyboard)

4-7-1. DATA Knob

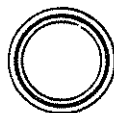



Continuously turning the DATA knob clockwise increases function data which is currently active. In the MARKER mode clockwise rotation of the DATA knob moves the marker to the right. In the DISPLAY LINE mode it moves the display line upwards. Turning the DATA knob counterclockwise decreases function data.

4-7-2. DATA Step Keys



The DATA step keys change function data in predetermined steps each time they are pressed. In the MARKER mode each operation of the step keys moves a marker one division on the horizontal axis of the CRT display.

Step size can be changed by using the  or  key. More detailed operations of these keys will be described in the sections "4-8 FUNCTION" and "4-9 MARKER".

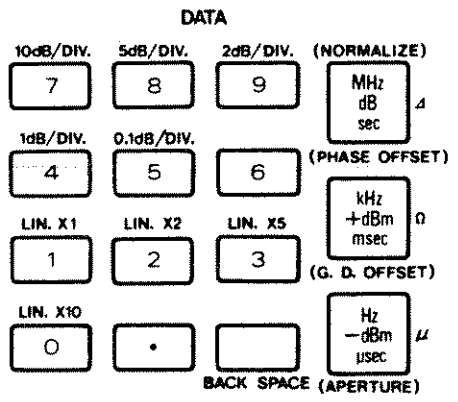

4-7-3. DATA Keyboard

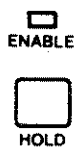

The DATA keyboard permits direct entry of numerical data. Function data can be entered by pressing a unit key after operating data number keys. If you have missed entry of number data, press the  key and then retry correct data entry.

4-7-4. HOLD



Data change or entry using the DATA knob, DATA step keys or DATA keyboard is inhibited by pressing the  key. (The  indicator lamp just above the HOLD key goes off.)

The HOLD state is cleared by operating a key other than the DATA controls or keys; the ENABLE indicator lamp goes on to indicate that data change or entry is enabled.

4-8. FUNCTION

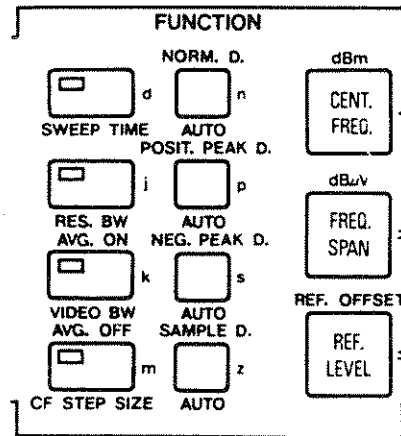
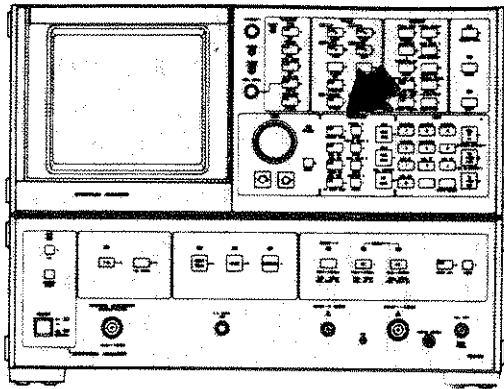

When the analyzer is initially switched on, center frequency, frequency span, reference level, etc. are automatically set to the initial values shown on Section 4-2-2. These values can be changed by using the FUNCTION keys and DATA controls.

Sweep time, manual setting of bandwidth (normally automatically set), or vertical scale can also be controlled with the FUNCTION keys and DATA controls. To specify function data first press the appropriate function key.

The activated function is shown on the left side of the CRT display. The data can be changed with the DATA knob, DATA step keys or DATA keyboard. The function remains active until another FUNCTION key or the MARKER key is operated.

The functions of the individual FUNCTION keys are described below.

4-8-1. CENT. FREQ.



This key is used to activate center frequency, which can be set over a range from 0 Hz to 1800 MHz. The maximum number of digits (resolution) of center frequency setting depends on the selected frequency span.

The DATA knob allows fine control of center frequency. The DATA step keys enables frequency shift in steps (normally 1/10 of the selected frequency span). The DATA keyboard enables direct entry of numerical center-frequency data. Using the DATA keyboard, the actual data entry occurs when one of the units keys, MHz, kHz or Hz, is pressed after numerical data is entered.

Center frequency is always shown at the bottom right corner of the display (except in Log Display mode).

4-8-2. FREQ. SPAN





This key is used to activate the frequency span.

Frequency span across the axis can be set over a range from 100 Hz to 2000 MHz; that across one division of the graticule is 1/10 of the frequency span.



The frequency span can be changed with the DATA knob or DATA step keys and DATA keyboard. The DATA keyboard enables direct entry of numerical frequency-span data.

The display always presents frequency span data at the bottom of the screen (except in Log. Display mode). When the RBW and VBW functions are set in AUTO mode, resolution bandwidth and video bandwidth are automatically set to the optimum according to the selected frequency span.

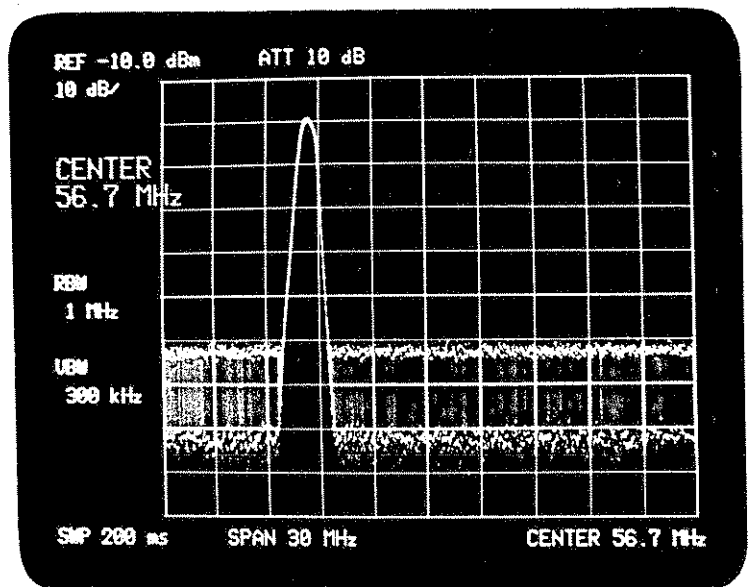
Example of  and  usage:



The signal to be measured is to the left of center of the display.

Reduce the center frequency with    to shift the signal to the right.

Then tune the signal to the exact center of the display with

 .

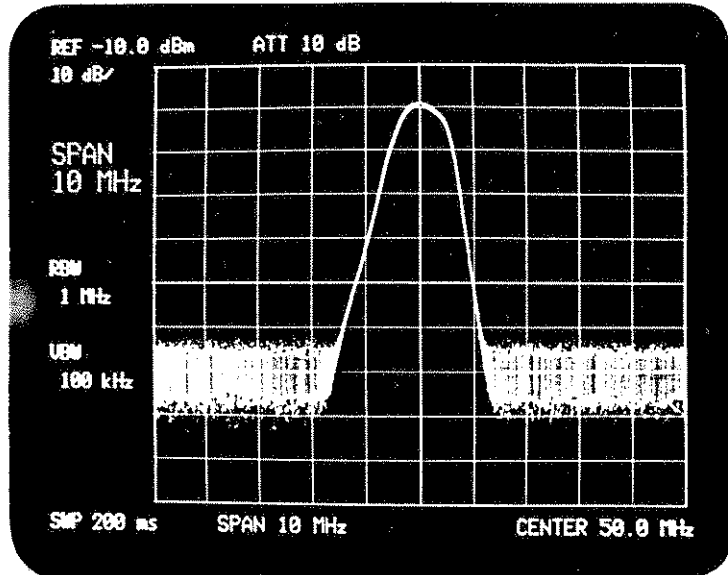

For better frequency resolution narrow the frequency span with

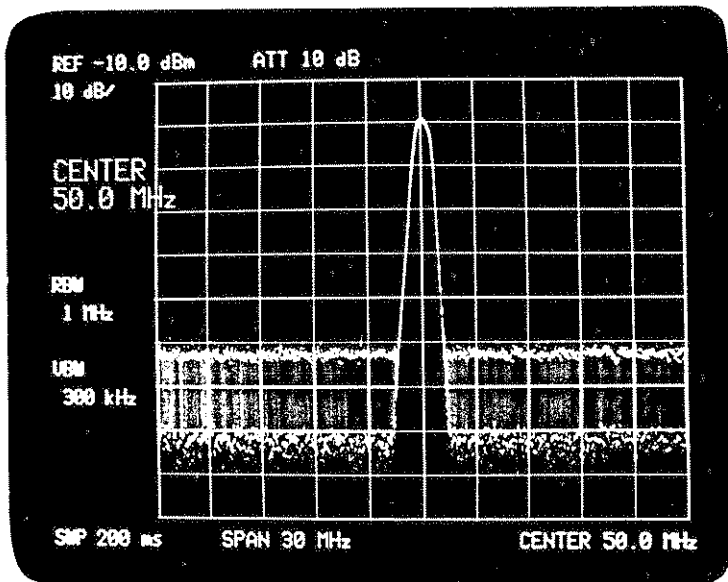

If the signal deviates from the center of the CRT when the frequency span is narrowed, reposition the signal to the center with the CENT. FREQ. key and DATA knob.

Zero Frequency Span:

When are pressed, the horizontal display axis becomes calibrated in time and the spectrum analyzer is fixed tuned to the center frequency. As a result, the analyzer operates as a receiver fixed tuned to the center frequency.

Press again to restore the normal spectrum analyzer function with the horizontal display axis calibrated for frequency.

4-8-3. REF. LEVEL



This key is used to activate the reference level at the top graticule of the CRT display. The reference level can be specified over a range from -90 dBm to +50 dBm in 0.1 dB steps. The DATA step keys control the reference level in 10 dB steps, while the DATA knob can control it in 0.1 dB steps.

The DATA keyboard enables direct entry of reference level values. For

entry of a positive value press , and for entry of a negative value press after keying in the numerical data.

The specifiable range of the reference level may be reduced to smaller than -90 dBm to +50 dBm depending on the input attenuator

setting. Reference level can be specified in dBu with .

Pressing returns the reference level readout to dBm.

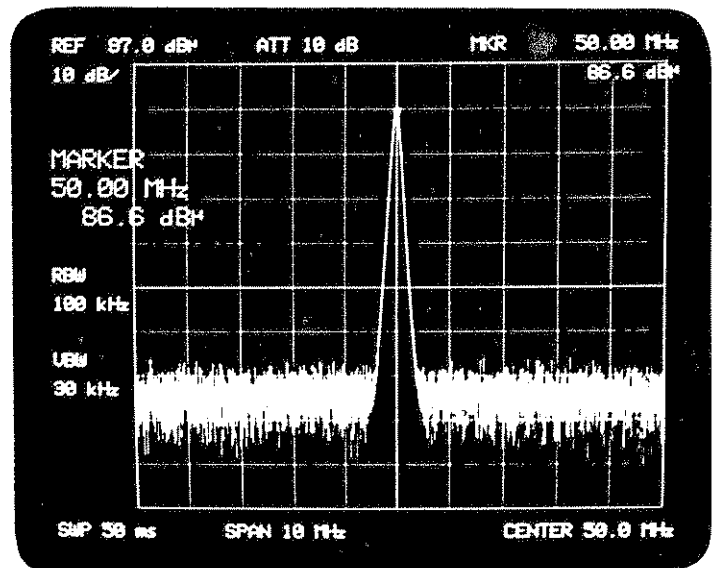

4-8-4. Vertical Scale Control

The scaling of the vertical graticule divisions of the CRT display is normally set in 10 dB/div.

Look at the top left corner of the display in the following figure. "REF -20.7 dBm" shows that the reference level is presently read in dBm, and "10 dB/" indicates that the scaling of the vertical graticule division is 10 dB/div. A unit of dBμ is also selectable (see paragraph 4-8-3). Scaling can also be selected from 5, 2, 1, and 0.1 dB per division, and linear scaling.

- For 5 dB/div. press .
SHIFT 5dB/DIV.
- For 2 dB/div. press .
SHIFT 2dB/DIV.
- For 1 dB/div. press .
SHIFT 1dB/DIV.
- For 0.1 dB/div. press .
SHIFT 0.1dB/DIV.
- For 0.5 dB/div. press .
SHIFT
- For 0.2 dB/div. press .
SHIFT

In the 0.1 dB/div., 0.2 dB/div., 0.5 dB/div., the effective range of the vertical scale is down to 8 divisions below the reference level, with display linearity not guaranteed in the bottom two divisions.

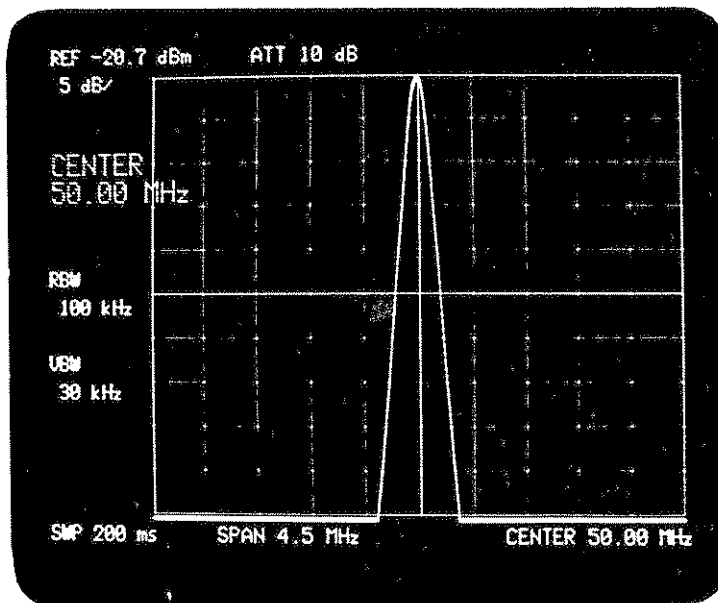
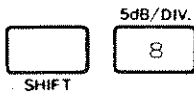

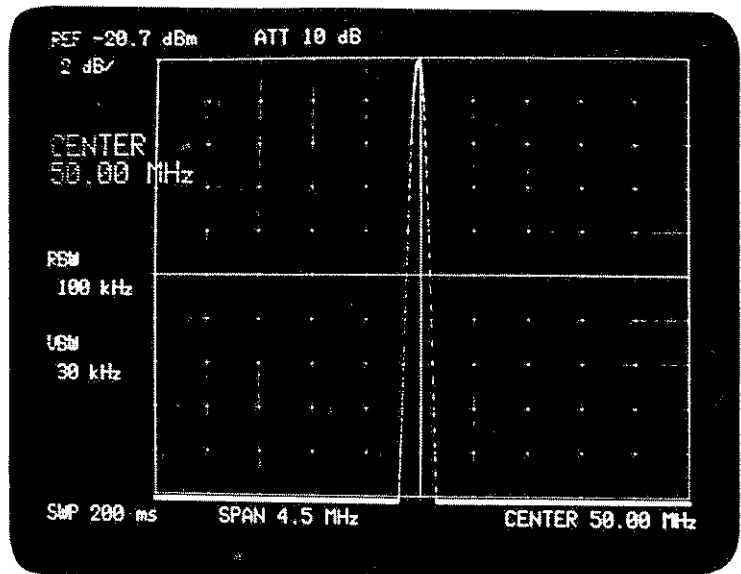

The scale can be set up for linear units to read amplitudes proportional to input signal power.

If are pressed linear scale x1 is selected, with the top and bottom graticules assigned to the reference and 0 V levels, respectively.

The scale can be changed in allowable increments of x2, x5, and x10 with , , and , respectively. In this case the reference level does not change.





4-8-5. SWEEP TIME



This key is used to activate sweep time within a range from 20 ms to 1000 sec. When the analyzer is initially switched on, sweep time control is set in AUTO mode, in which it is automatically set according to frequency span, resolution bandwidth or video bandwidth to minimize level error.

clears the AUTO mode to permit manual setting of sweep time (indicator on the key goes on) with the DATA knob, DATA step keys, or DATA keyboard.

again selects the AUTO mode for sweep time control; the indicator on the key goes off.

If sweep time is set too long in the AUTO mode, it can be temporarily reduced with     for quick observation of signal response. In this case, if the error of level reading exceeds 0.5 dB, message "UNCAL" will be shown.



Once the outline of the signal response is checked, restore the AUTO mode so the UNCAL message is cleared.

In Zero Frequency Span mode, sweep time can be set between 100 μ s and 1000 sec.

4-8-6. RES. BW



This key is used to activate resolution bandwidth (IF bandwidth). AUTO automatically sets resolution bandwidth according to the selected frequency span.

 permits manual setting of resolution bandwidth with DATA controls. A signal response can be separated from its adjacent noise response or two or more signal responses can be separated from each other, by narrowing the resolution bandwidth. The DATA key () may be conveniently used to narrow the resolution bandwidth. When sweep time control is in AUTO mode, sweep time is increased as resolution bandwidth is narrowed.

4-8-7. VIDEO BW



This key is used to activate video bandwidth within 1 Hz to 1 MHz in 1 or 3 sequence.



AUTO automatically sets video bandwidth to the optimum according to the selected frequency span.

Signal responses near the noise level of the analyser will be visually masked by the noise. The video filter can be narrowed to smooth this noise, although a longer sweep time will be required when the video bandwidth is narrowed.

With the video averaging feature, which digitally averages the signal responses for each sweep, a better signal-to-noise ratio can be expected with a shorter sweep time. For more details see Section 4-14-1. Averaging.

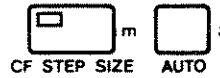

4-8-8. CF STEP SIZE





This key is used to activate the center frequency step size for center frequency control using  .

AUTO automatically sets the step size to one tenth the frequency span. Surveillance of a wide frequency span sometimes requires high resolution. One fast way to achieve this is to take the span in sequential pieces using a tailored center frequency step. This technique is described below:

Set the center frequency and frequency span for the lowest frequency range of the signal response to be measured.

Press  and then use the DATA keyboard to enter the same value as the frequency span. Activate the center frequency with .

Now each  sets the center frequency to the next span.

Center frequency step size can also be specified with .

For more details see Section 4-9. MARKER.

4-9. MARKER

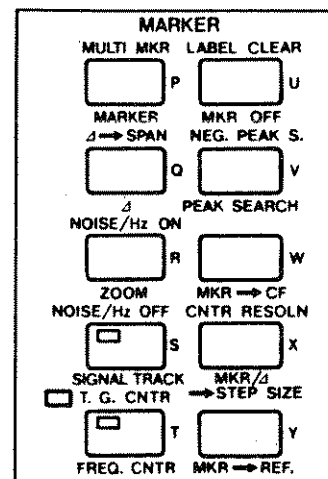
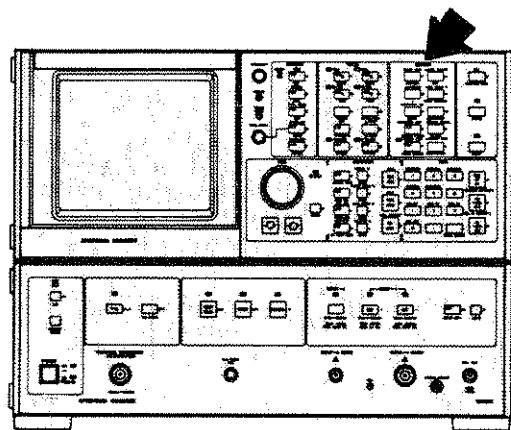

Use of the MARKER controls increases the speed and accuracy of many measurements. The Multi Marker mode presents up to 10 markers available on the display.

4-9-1. MARKER

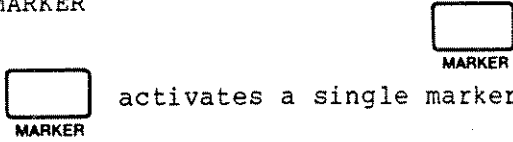

activates a single marker at the center of the display or at the last marker spot.

The frequency and amplitude at the marker will be shown on the active function display area. The same data readouts are presented at the top right corner of the display as well. While the MARKER is normally abbreviated as "MKR" for readout, it is read as "COUNTER" or "CNTR" in the FREQ. CNTR mode or T.G. CNTR mode (to be described later).

An active marker can be moved on a signal response trace with the DATA controls. The DATA knob can continuously control marker position for fine tuning. The DATA step keys move the marker in steps of one division each for faster control.

Use of the DATA keyboard can directly specify the frequency to which the marker is to be positioned. IF a frequency outside the present frequency display range is entered with the DATA keyboard, the marker is positioned to the leftmost or rightmost graticule.

The readouts of marker frequency and amplitude change with the movement of the marker.

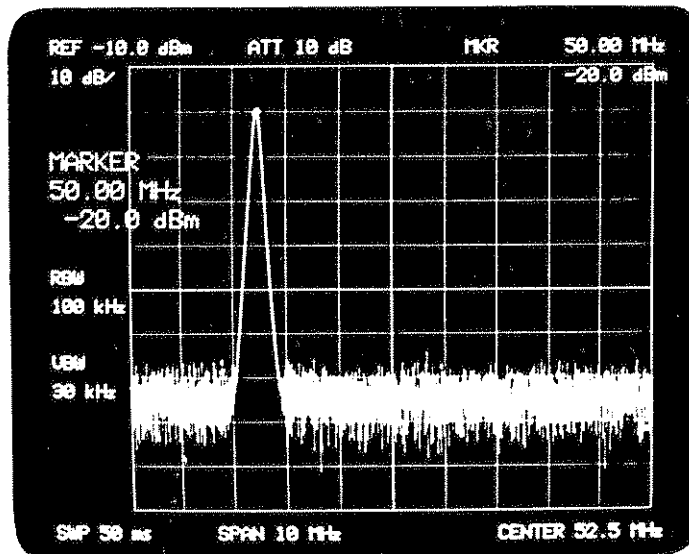

When another function key (such as CENT. FREQ.) is pressed, the marker is deactivated. To activate the marker again press MARKER. A marker which can be controlled with the DATA controls is called an active marker.

When a marker is active, the marker can be positioned on the desired trace by operating the VIEW or WRITE key for the trace memory A, A', B, or B' (see Section 4-10-1(6)).

4-9-2. MKR OFF







Operation of the MKR OFF key clears all markers from the display. If the MARKER key is pressed, a marker will appear again on the last marker spot.

4-9-3. Δ (Delta) Key





 presents two markers on the display. Only one of the two markers is activated and the differences in frequencies and amplitudes of the two markers are read out. The following example shows a measurement of frequency and amplitude differences between two signal responses:

Press **MARKER** to obtain the normal marker mode in which a marker is activated. Position the marker to the peak of one signal response with   

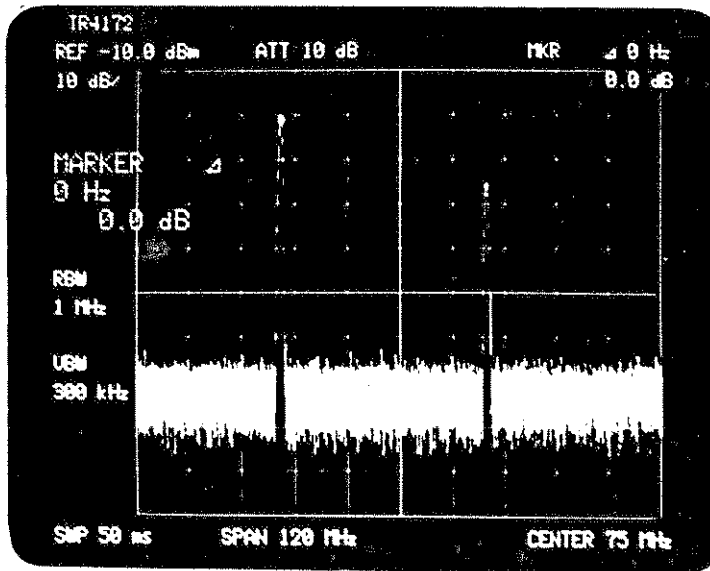
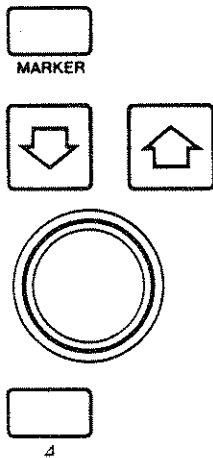
Press . The display will present a second marker which is active. The first marker is deactivated and remains at the peak of the first signal response. The two markers overlap each other and appear as if a single marker.



Position the second marker to the peak of the second signal response trace with   . Now the differences in the frequencies and amplitudes of the two signal responses are directly read out.

To return the analyzer from delta mode into normal marker mode press the **MARKER** key. Only one active marker will be left on the display.

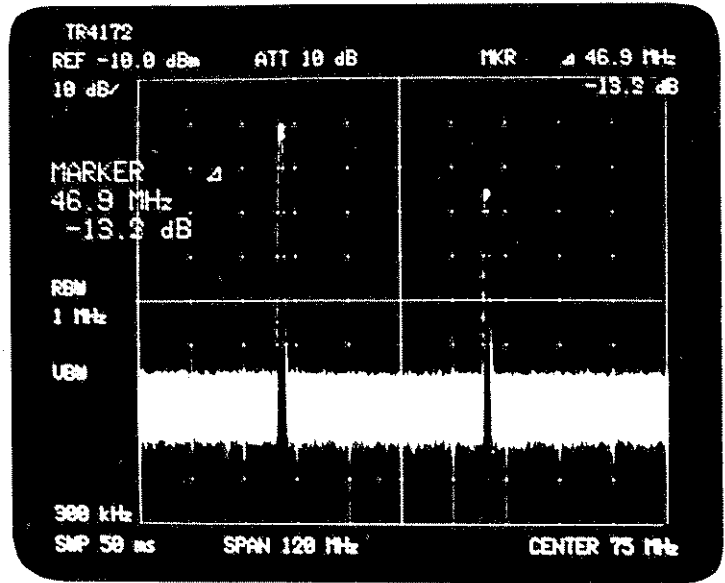
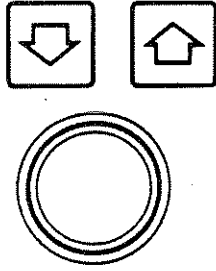

4-9-4. PEAK SEARCH



PEAK SEARCH

Operation of the PEAK SEARCH key places a single marker at the peak of the maximum trace response.

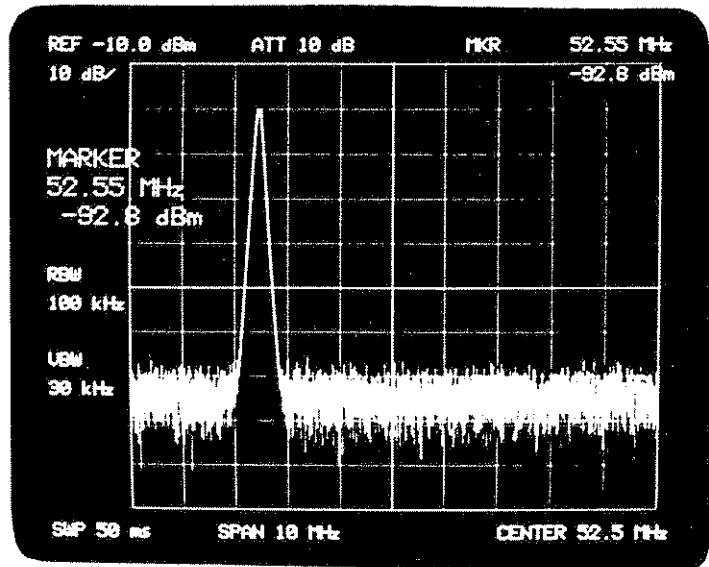

PEAK SEARCH

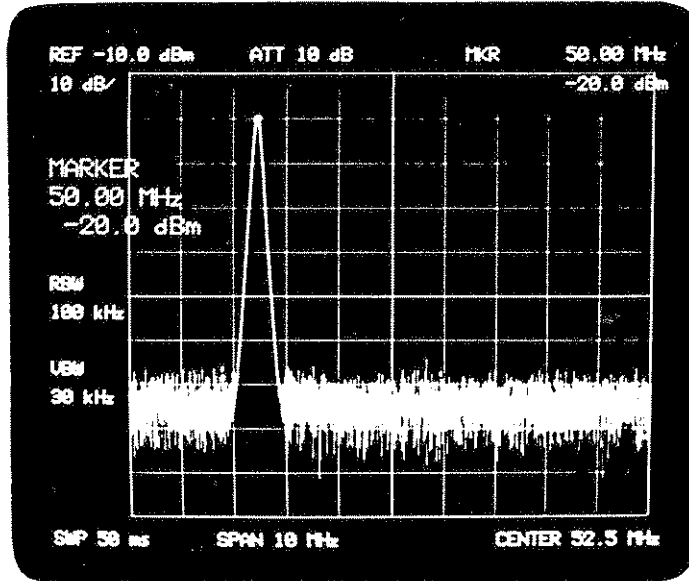

Successive peak search

If are pressed, the analyzer enters successive peak search mode, in which the active marker repeats peak searching after each sweep.

Pressing MKR OFF key cancels the successive peak search mode and erases the marker.

4-9-5. ZOOM

ZOOM

Use of the ZOOM key with the DATA step keys can zoom in a signal specified by a marker. In other words, the zoom operation narrows the frequency span and positions a marker to the center of the CRT display.

In the zoom mode, the DATA controls have functions different from those in other modes.

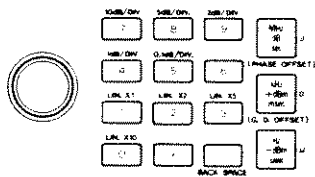





The Data step keys position a marker to the center of the display while controlling the frequency span.

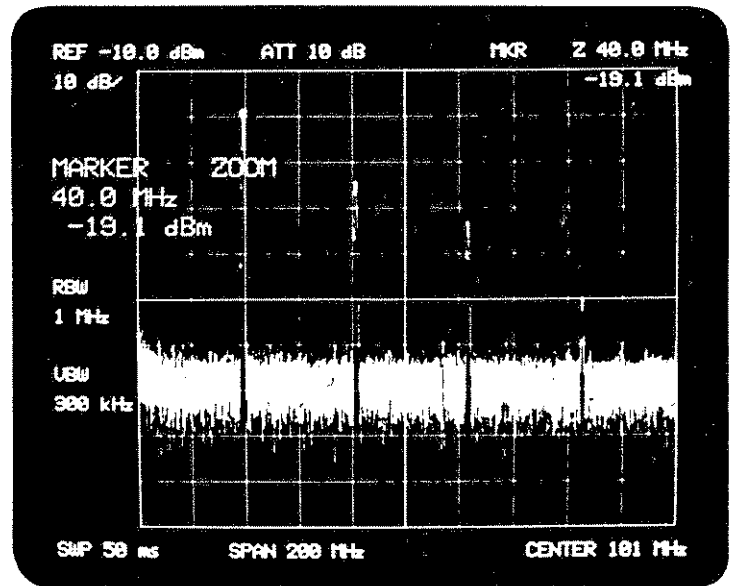
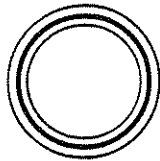

presents an active marker on the display.

Position this marker to the peak of the signal response trace to be measured.



Each time  is pressed, the frequency span is narrowed in 1-2-5 sequences while the marker is moved towards the center of the display.

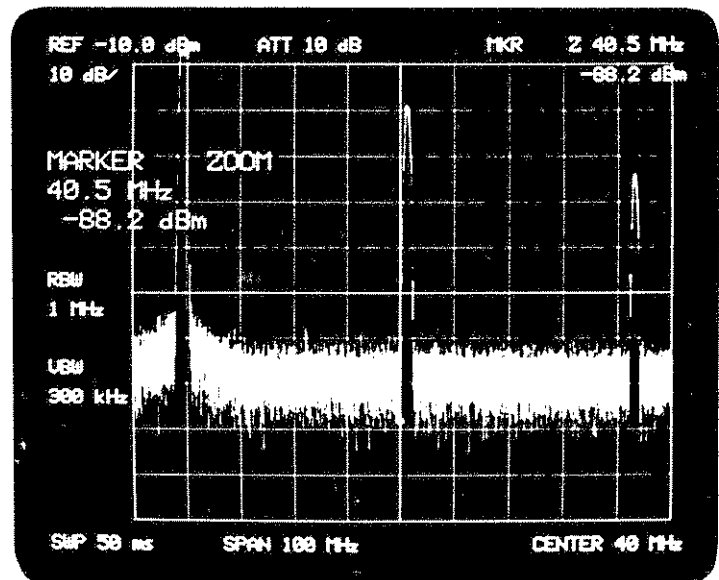

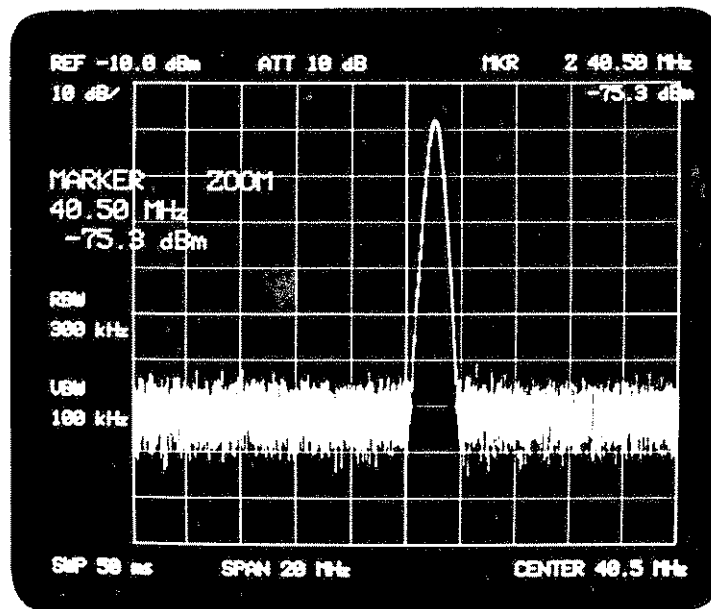

If the marker deviates from the signal peak as shown above, reposition it to the peak with the DATA control.

To return the analyzer from ZOOM mode to normal MARKER mode press the MARKER key.

4-9-6. MKR → CF



Operation of the MKR → CF key substitutes a marker frequency for a center frequency.

Press to activate a single marker and then position the marker to the peak of the signal response trace with DATA knob.

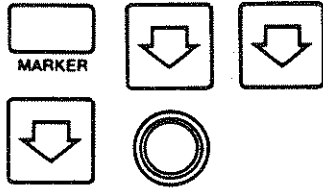

The signal frequency is read out as 40.04 MHz.

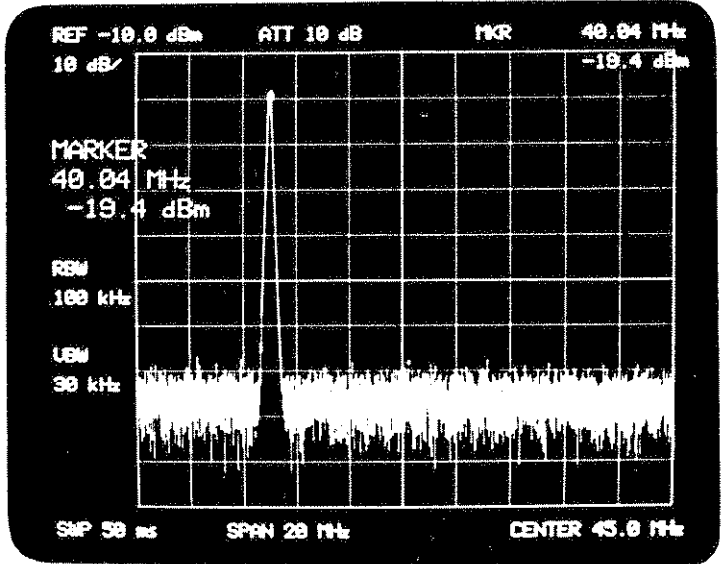

Press the MKR → CF key. The center frequency is set at 40.0 MHz and the signal response trace is positioned to the center of the display along with the marker.

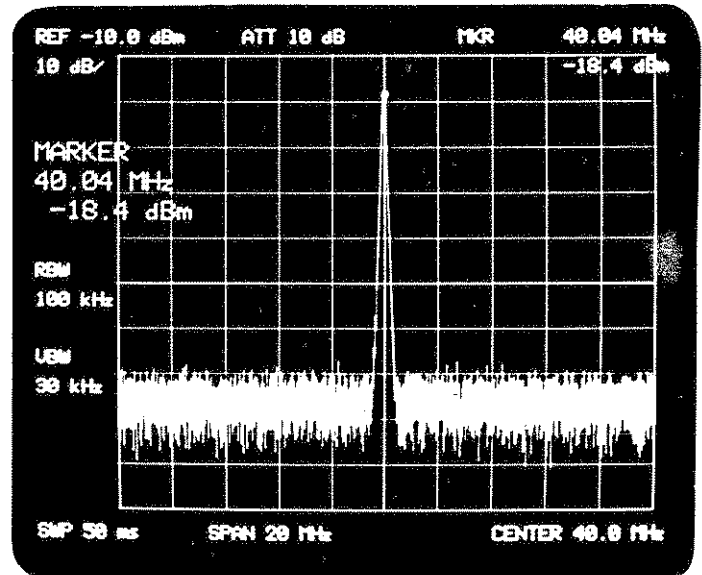

To press the MKR → CF key more than once, wait until the first marker repositioning is finished, then press the MKR → CF key for the second time.

4-9-7. SIGNAL TRACK



The analyzer can automatically maintain a drifting signal at the center of the display. To operate signal tracking, press  ; the indicator lamp on the key will go on to indicate that the signal tracking mode is entered.

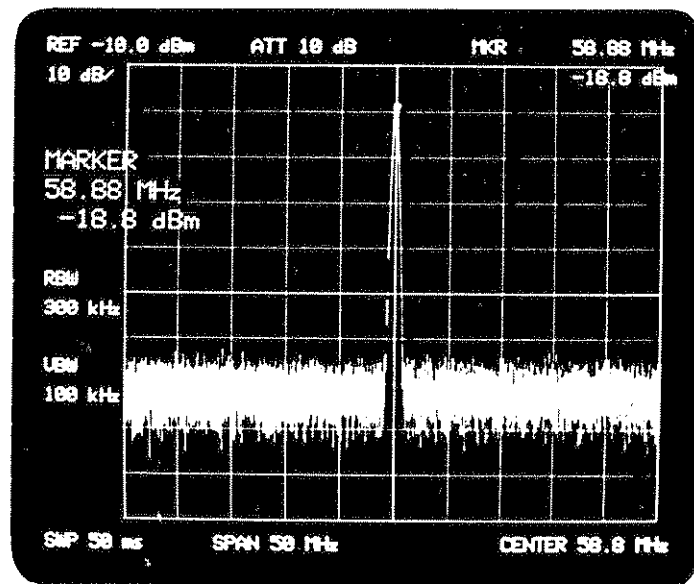
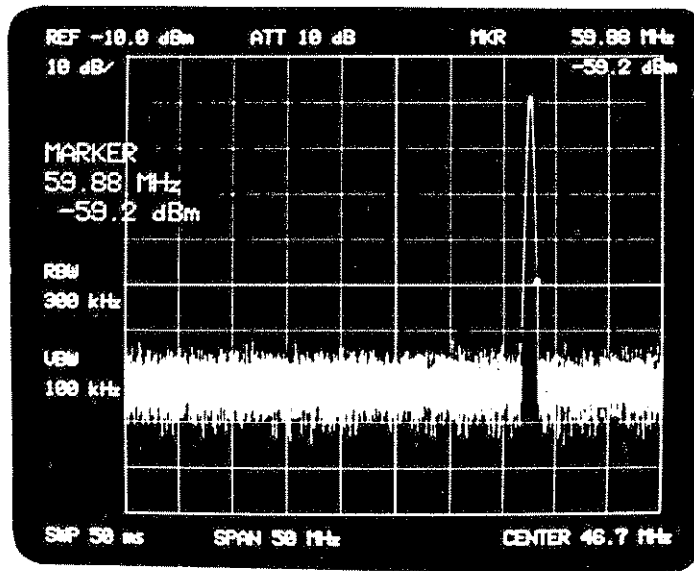

A second depression of the SIGNAL TRACK key will turn off the key indicator lamp and return the analyzer to the normal MARKER mode. Operation of the MARKER, OFF, Δ, or PEAK SEARCH key also clears the SIGNAL TRACK mode and activates the corresponding mode for which the key is pressed.

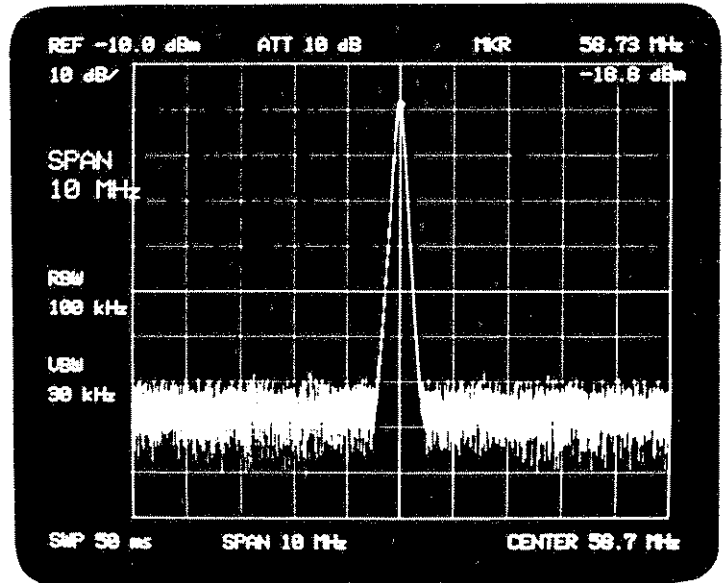

A drifting signal can be zoomed in the SIGNAL TRACK mode with







On the above example of the signal tracking mode, the frequency span was narrowed by using the "DATA STEP DOWN" key several times. Instead of using the key, the desired frequency span can be directly entered from the DATA keyboards. After the entry of the narrower frequency span by the DATA keys, the signal is zoomed step by step, tracking the signal at the center of the display. During this

zooming of the signal tracking mode, "AUTO ZOOM" is displayed at the active function area, and all the keys but the  and  keys are inoperative until the zooming stops. To stop the auto zooming on the signal tracking mode, use either of the above two switches.

4-9-8. MKR/ Δ \rightarrow STEP SIZE



- (1) In the normal MARKER mode, operation of the  key substitutes marker frequency for center frequency step size data.
- (2) In the DELTA MARKER mode, operation of the  key substitutes frequency difference between two markers for center frequency step size data.
- (3) Center frequency can be controlled in steps with  and   with the step size determined in above steps (1) or (2).

For example, when measuring a fundamental wave and its higher harmonics, press MARKER switch to activate a single marker and position it to the peak of the fundamental wave. Then use the SIGNAL TRACK, FREQ. SPAN, and DATA step keys to zoom in on the fundamental wave at the center of the display.

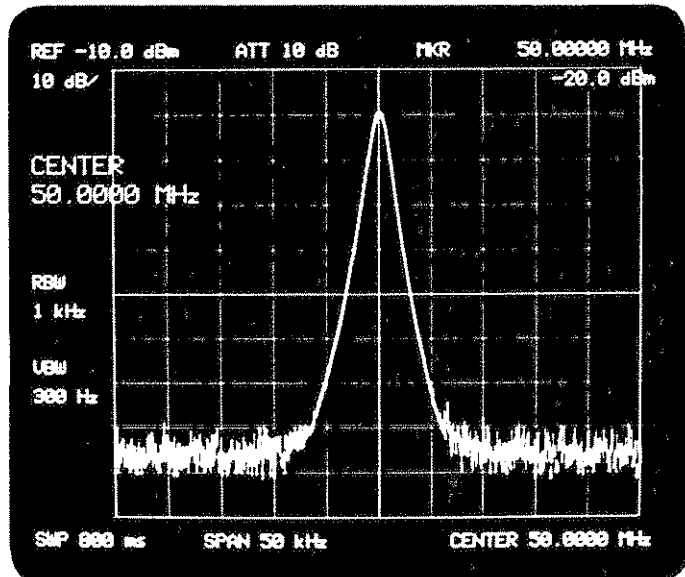
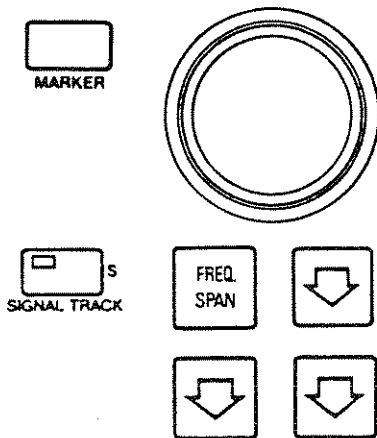

Next press the MKR/ Δ \rightarrow STEP SIZE key to substitute the marker frequency (fundamental wave frequency) for the center frequency step size; the indicator lamp on the CF STEP SIZE key will light. Press the CENT. FREQ. key to activate center frequency, then press  . The center frequency is doubled and the second harmonic can now be observed.

Each time  is pressed subsequently, the third, fourth, and subsequent harmonics can be observed.

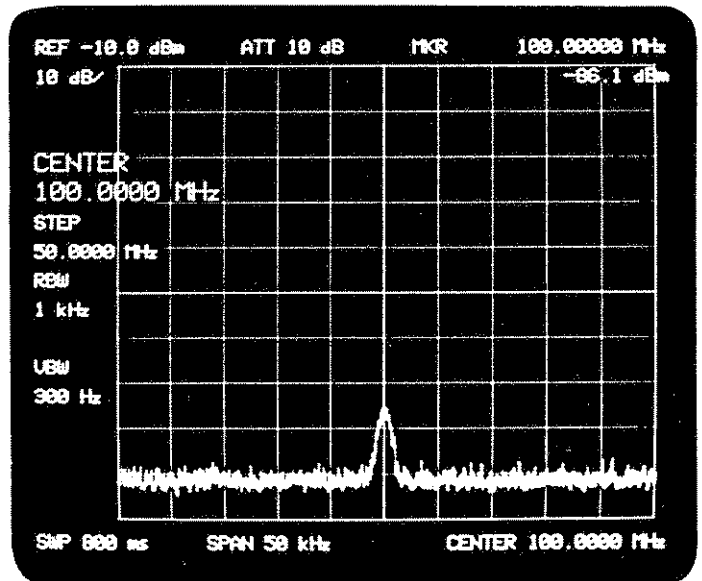
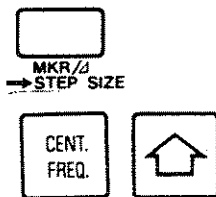

4-9-9. T.G. CNTR



The T.G. CNTR mode counts the frequency of signals with great precision and accuracy. To activate the T.G. CNTR mode press

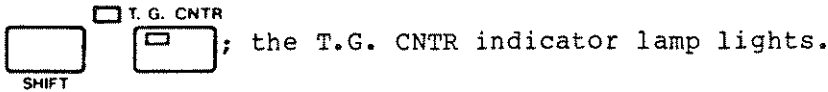

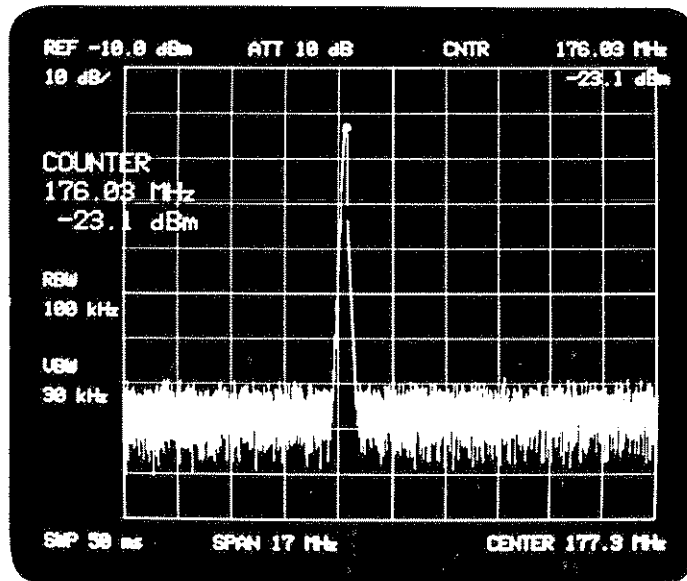

In the normal MARKER mode marker frequency is calculated from the marker position on the graticule and the center frequency, whereas in the T.G. CNTR mode, marker frequency is directly counted by the built-in counter.

Marker frequency is read as CNTR XXX Hz at the top right corner of the display. To return the analyzer to the normal MARKER mode press



In the T.G. CNTR mode the resolution of the counter can be increased up to 1 Hz as follows:

Press the SHIFT key and then the FREQ. CNTR key to activate the T.G.

CNTR mode. Then press  . The display will show message COUNTER RESOLN.

Now enter the desired resolution data (least significant digit) from the DATA keyboard.

Note that an excessively high counter resolution causes an extended gate time and hence delayed display writing. Also note that signal tracking is not usable in the T.G. CNTR mode.

4-9-10. **FREQ. CNTR**



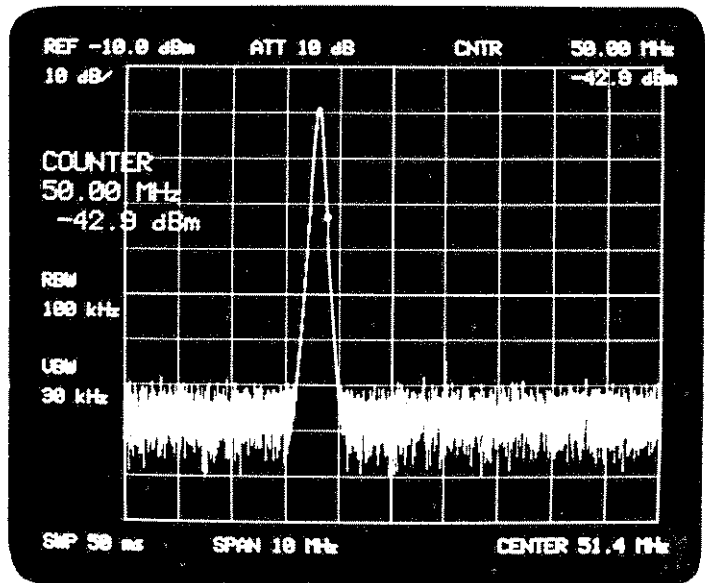

Operation of the  keys activates **FREQ. CNTR** mode; the indicator lamp on the key will light.

The **FREQ. CNTR** mode permits precision measurement of the frequency of a signal (on which a marker is positioned) the level of which is more than 15 dB higher than the noise level. For the measurement the marker need not be positioned at the signal peak.



The frequency readout indicates not the marker frequency but the frequency of the signal on which the marker is positioned, though the amplitude readout indicates the amplitude at the marker.





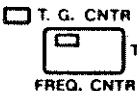

In the **FREQ. CNTR** mode the title for frequency and amplitude readouts is **COUNTER** or **CNTR**, which is the same as that in the **TG CNTR** mode.

To increase the frequency counter resolution, press   and then enter the desired resolution data (least significant digit to be read) from the **DATA** keyboard. To return the analyzer from the **FREQ.**

CNTR mode into the normal **MARKER** mode press  again. The indicator lamp on the key will go off to indicate that the normal **MARKER** mode is restored.

CAUTION

For products having serial numbers below 30690130, a  key is installed instead of a  key, and different designations are used for these keys. The normal mode and shift mode functions of the keys of the old and new products are reversed. (See the table below.) A GPIB program generated using the existing FC and SHFC codes can be used for the new product.

Function	Key operation		BPIB code
	Old product	New product	
Measures signals 15dB or more above the noise level and having a marker	 		CN (SHFC)
Directly measures the marker frequency		 	SHCN (FC)

4-9-11. MKR → REF.



MKR → REF.

This key is used to substitute the amplitude at a marker for a reference level

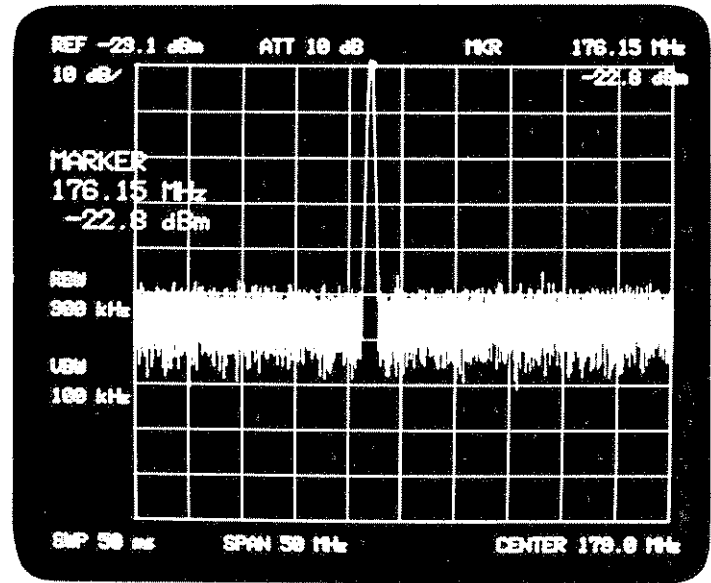
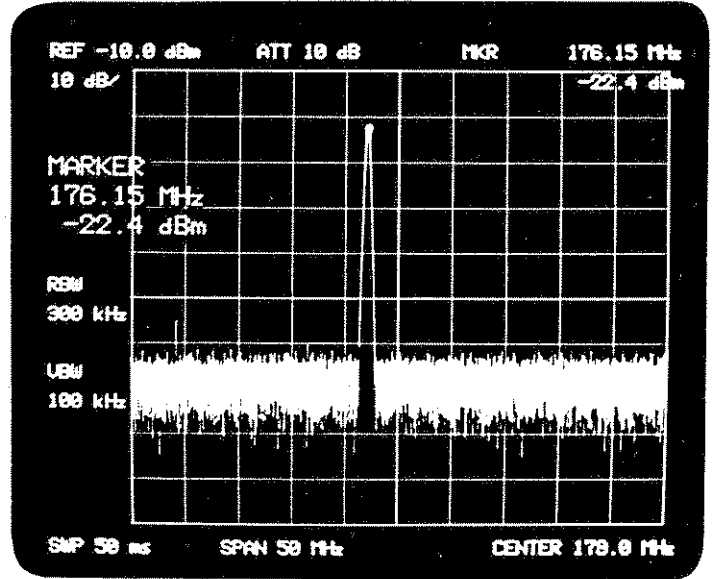

4-9-12. Multi Marker Mode



The Multi Marker mode allows the display to present more than one and up to ten markers at a time.

If are pressed, "MULTI MARKER" will be shown on the active function display area. Use the DATA keyboard to enter the number of markers to be displayed.

Then press the HZ key to register the entry data as the number of markers. Markers are presented on the display up to the programmed number each time the MARKER key is pressed. The following example shows display of three markers:

Press , then enter 3 HZ from the DATA keyboard. When the MARKER key is pressed the first time the first marker appears on the display. Position the marker to the desired signal response trace. The frequency and amplitude at the marker are shown on the active function display area and at the top right corner of the display. The second and third markers appear on the display when the MARKER key is pressed a second and third time respectively.

Set up the analyzer for

Multi Marker mode with

.

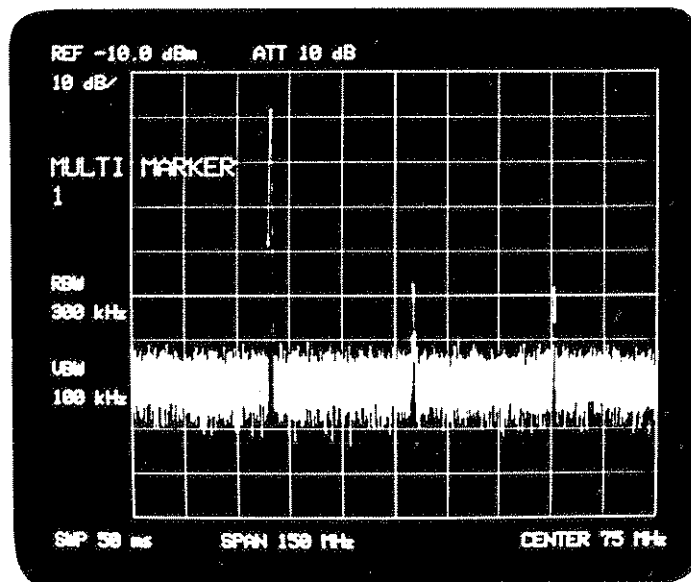

Set the number of markers to

3 with

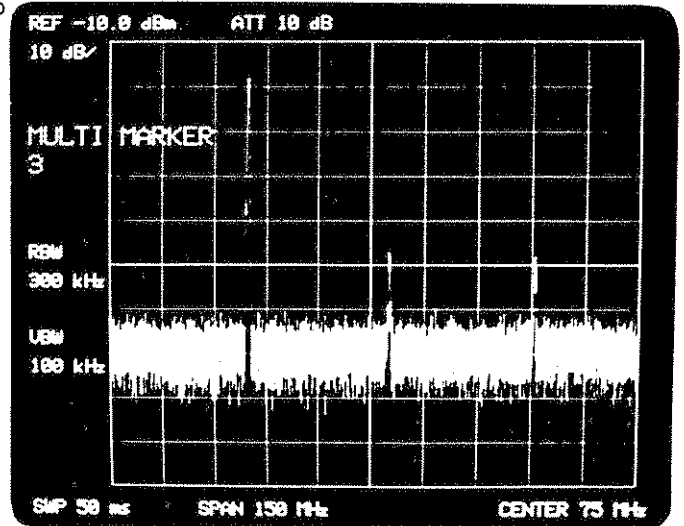

Activate the first marker

(MKR 1) with

MARKER

and place the marker on a signal with

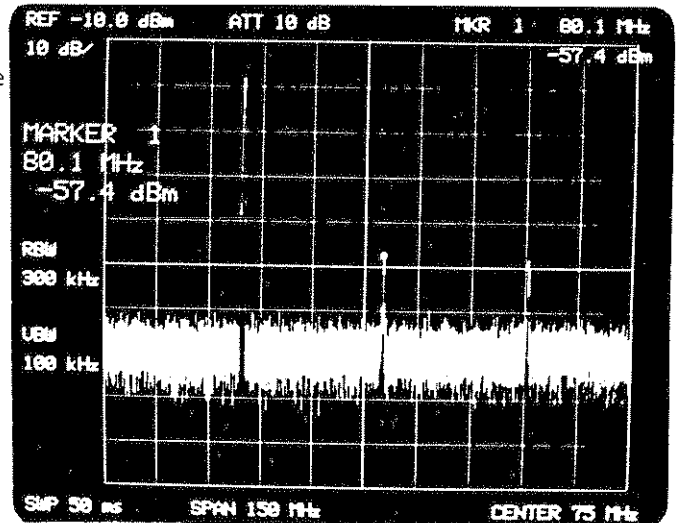
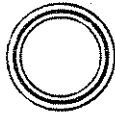

Generate the second active

marker (MKR 2) with

MARKER

and place the marker on a

signal with

The first marker is deactivated.

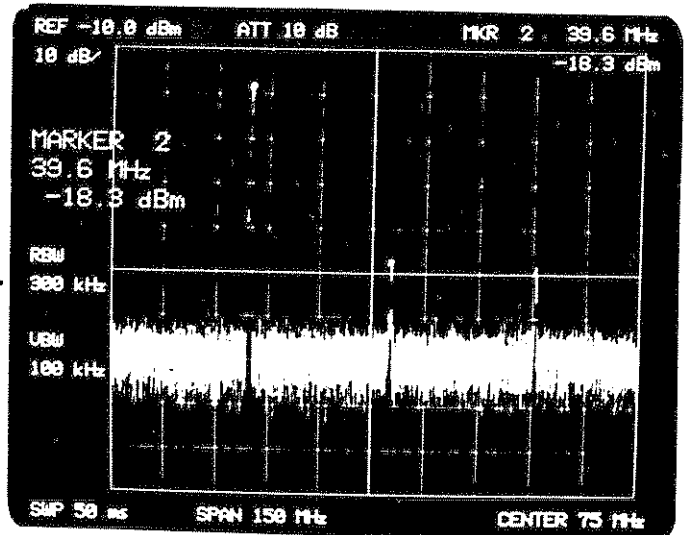

Generate the third active marker (MKR 3) with MARKER and place the marker on a signal with .

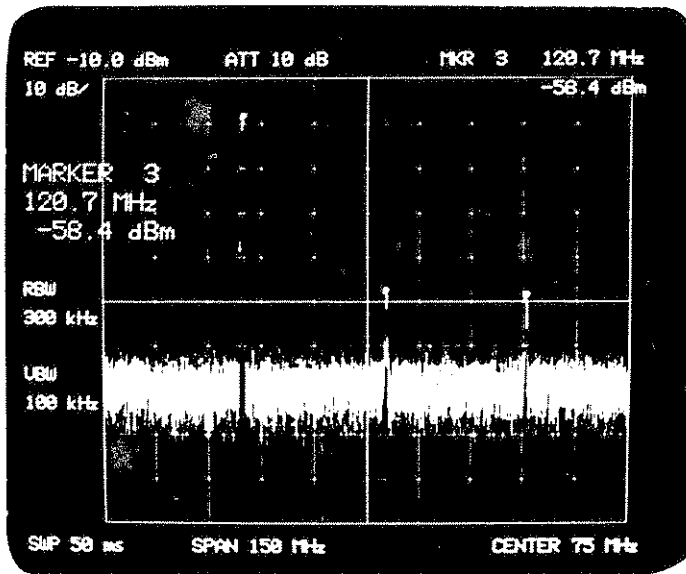

Now there are three markers presented on the display.

Subsequent operations of the MARKER key will activate the three markers successively.

An active marker is highlighted. Operation of the MKR OFF key erases all markers from the display, yet the last positions of the markers and the programmed number of multi markers are left in the internal memory. So the markers can be recalled on the display one after another each time the MARKER key is pressed. To change the

programmed number of multi markers press SHIFT MULTI MKR, then enter the new number of markers (between 1 and 10) from the DATA keyboard before pressing the Hz key.

To return the analyzer from Multi Marker mode into the normal MARKER mode, set the number of multi markers to 1 with



4-9-13. $\Delta \rightarrow$ SPAN

If SHIFT $\Delta \rightarrow$ SPAN are pressed when the analyzer is in the Delta Marker mode, the center frequency and frequency span are set so that the frequency range between two markers occupies the entire frequency span. In this case the two markers need not be active.

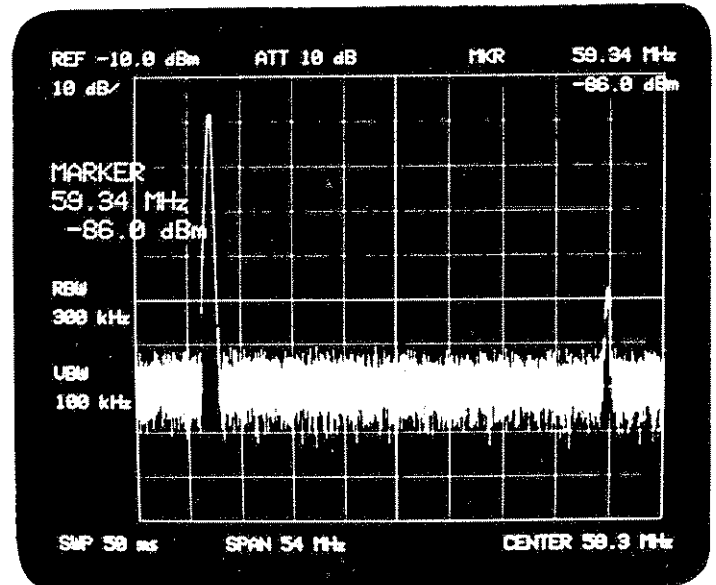
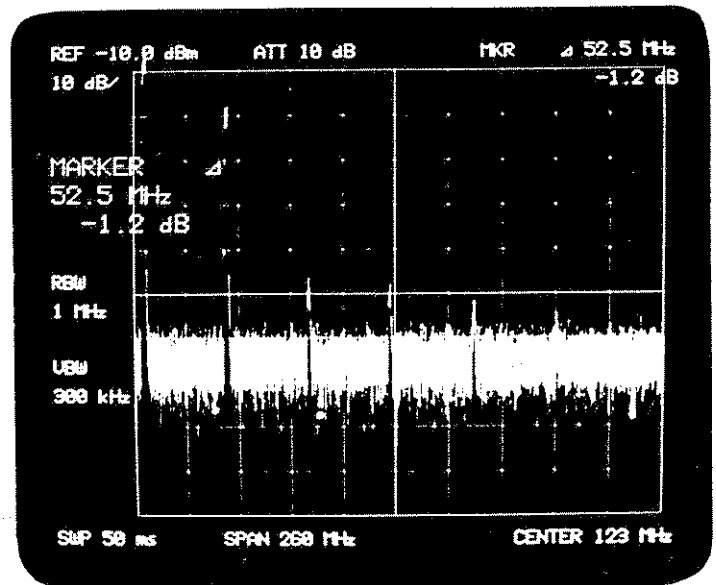

The analyzer is returned from the Delta Marker mode to the normal MARKER mode with a marker appearing at the center of the display. The frequency span is slightly greater than the difference in the two marker frequencies (Δ).

The center frequency is set at the left-side marker frequency plus span/2.

In the Delta Marker mode the $\Delta \rightarrow$ SPAN key is operative irrespective of whether the left or right marker is active.

4-9-14. NEG. PEAK S.

Operation of the SHIFT and NEG. PEAK S. (Negative peak search) keys places an active marker at the bottom of the lowest signal response trace.

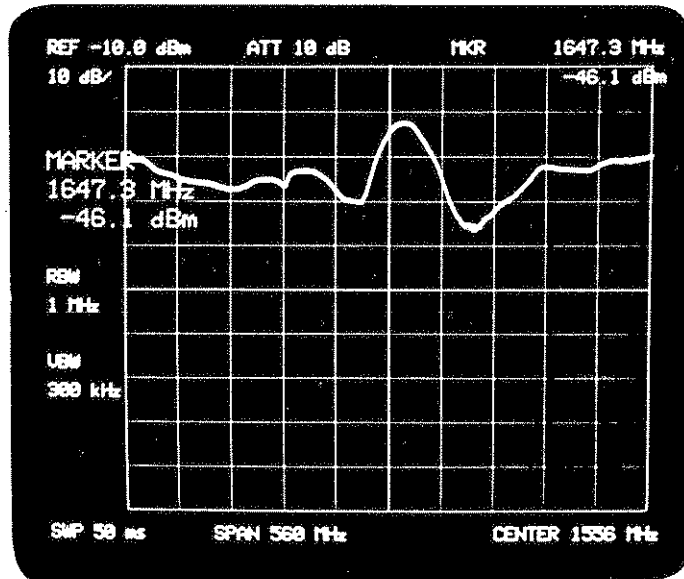
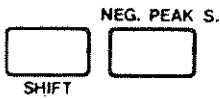
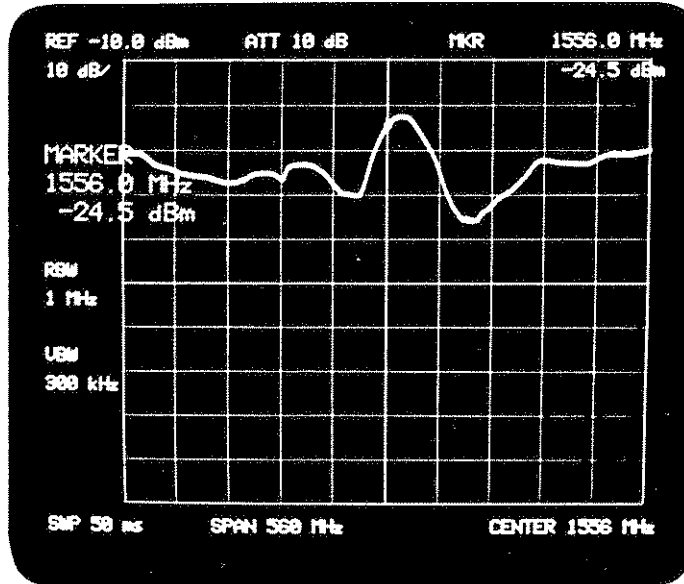

4-9-15. Noise Level Measurement

When noise level measurement is activated and the marker is placed in the noise, the rms noise level is read out normalized to a 1 Hz noise power bandwidth. To activate the noise level measurement press

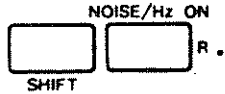

The marker level readout on the display reads XX dBm/Hz, indicating the noise level measurement mode. To obtain a noise level over a bandwidth greater than 1 Hz, add the following value to the readout:

$$10 \log_{10} \left(\frac{\text{bandwidth}}{1 \text{ Hz}} \right)$$

To return the analyzer from the noise level measurement mode to the normal MARKER mode, press

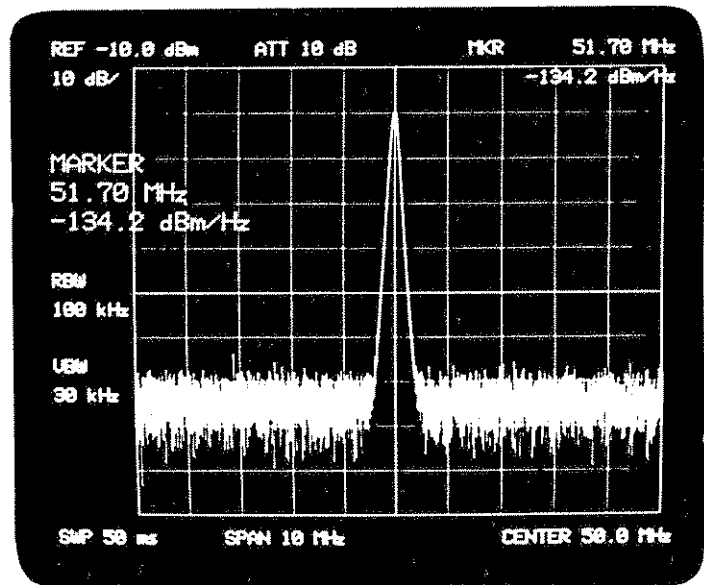
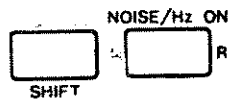
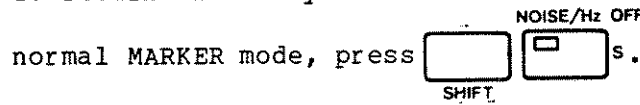

4-10. TRACE

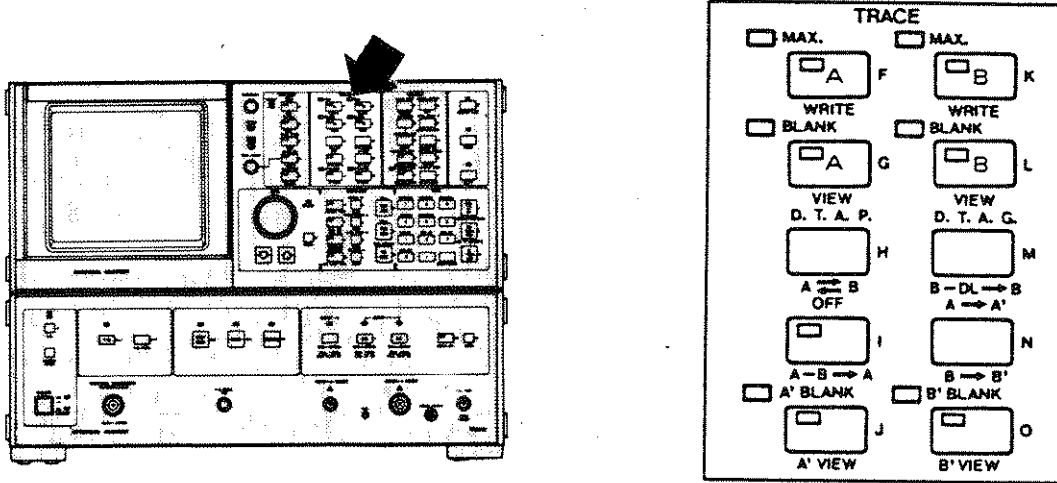

In the TRACE mode, up to four different signal response traces are converted to the corresponding digital information and stored in internal trace memories which can then be transferred to the CRT display. The trace memory consists of memories A, A', B, and B'. Memories A' and B' are auxiliary to memories A and B respectively. This section describes the basic operating procedures in the TRACE mode, then presents simultaneous four trace display.

4-10-1. Basic Operation Procedures in TRACE mode

(1) WRITE and VIEW



WRITE and VIEW keys are provided for memories A and B.

When the WRITE key is pressed, the analyzer signal response is written into trace memory during the sweep and the memory contents are displayed on the CRT.

As a result, the signal response trace on the CRT varies with sweep rate.

When the VIEW key is pressed, no updating of the trace memory is made and the result of the latest sweep is saved and displayed on the CRT.

The WRITE mode can be selected for only either of memory A or memory B at a time.

Memories A' and B' have only VIEW keys and have no WRITE keys. The A → A' (B → B') key is used to write information into memories A' and B', respectively.

a. WRITE A

When the WRITE A key is pressed, the analyzer signal response is written into trace memory A during each sweep and the memory contents are displayed on the CRT. The indicator lamp on the WRITE A key goes on to indicate the WRITE A mode. When the analyzer is initially switched on or the MASTER RESET key is pressed, the instrument is automatically placed in the WRITE A mode.

b. VIEW A

If the VIEW A key is pressed in the WRITE A mode, updating of trace memory A is no longer made and the current memory data is displayed on the CRT.

If the VIEW A key is operated in the BLANK A mode (to be described later), the contents of trace memory A is recalled on the CRT.

c. WRITE B

When the WRITE B key is pressed, the analyzer signal response is written into trace memory B during each sweep and the memory contents are displayed on the CRT.

The indicator lamp on the WRITE B key goes on to indicate the WRITE B mode.

The WRITE mode can be selected for only either of memory A or memory B at a time. The memory for which the WRITE key is pressed most recently is placed in the WRITE mode. If the WRITE B key is pressed in the WRITE A mode, memory A is placed in the VIEW A mode and memory B is placed in the WRITE B mode. In this case, active contents of memory B are overlapped on stationary trace A.

d. VIEW B

If the VIEW B key is pressed in the WRITE B mode, updating of trace memory B is no longer made and the current memory data is displayed on the CRT.

e. Example of WRITE and VIEW mode usage

A simple example of the WRITE and VIEW mode usage using the CAL. OUT. signal is described below:

Press the AC key for INPUT-1. Connect the CAL. OUT. connector to the INPUT-1 connector with the supplied input cable MI-02 (with the N-BNC adapter JUG-201A/U attached to the INPUT-1 connector). Set the CENT. FREQ. to 50 MHz and FREQ. SPAN to 10 MHz. IF the analyzer is not in the WRITE A mode press the WRITE A key.

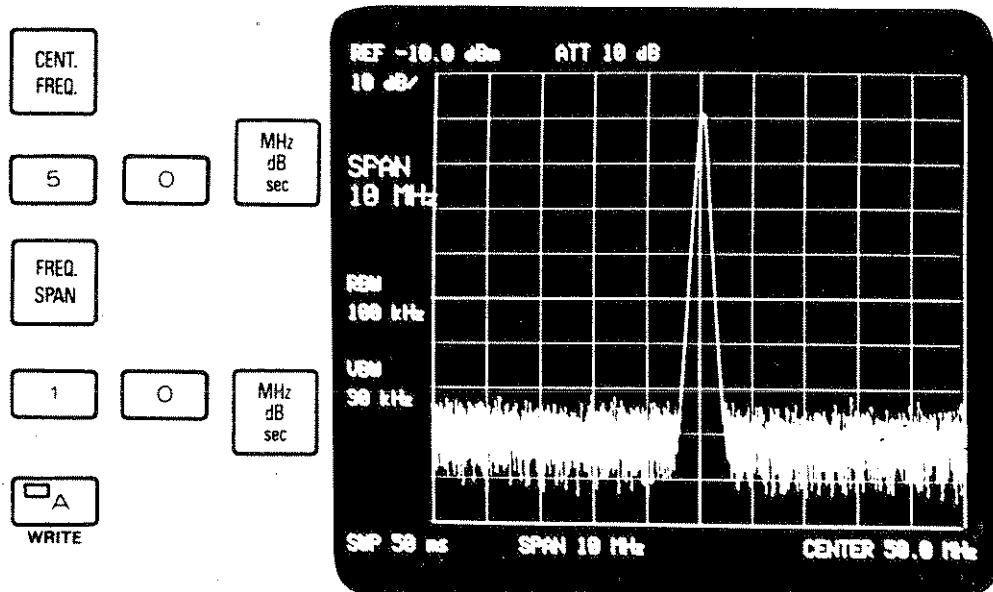

Then press the WRITE B key. Trace memory B is placed in the WRITE mode and memory A is placed in the VIEW mode with trace A frozen. Press the CENT. FREQ. key and adjust the DATA knob. Active trace B can now be observed together with inactive trace A.

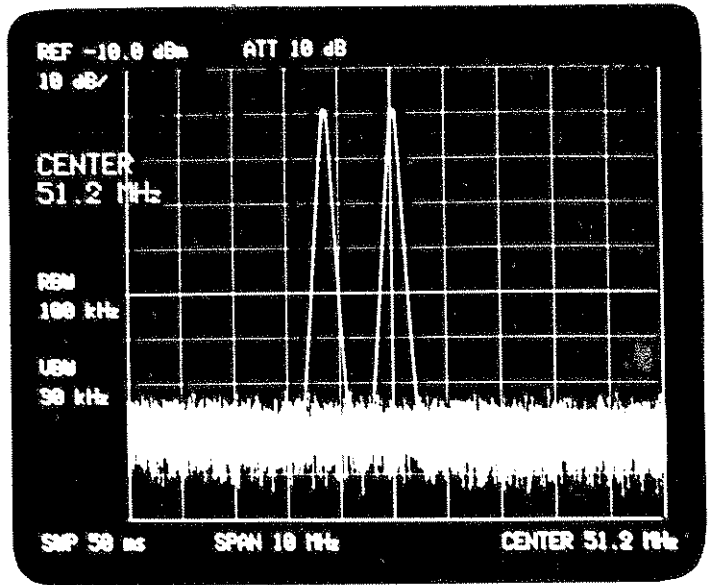
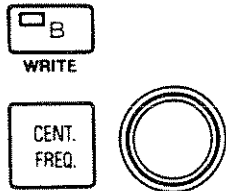

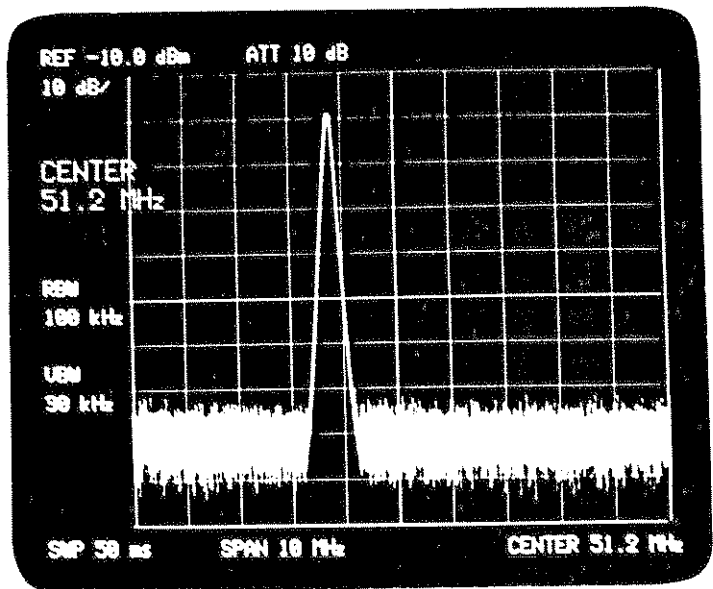

Press the WRITE A key again to select the WRITE A and VIEW B mode. Trace A is now overlapped with frozen trace B.





f. B → B', A → A', VIEW A', VIEW B'

These keys are used to transfer the contents of memory B to memory B' or those of memory A to memory A'.

Pressing   transfers the contents of memory B to memory B'.





Each trace is generated from 1001 points across the graticule. Odd numbered 500 points out of the 1001 points of trace B are written into memory B'. Even numbered 501 points leave in memory B.

   stores the contents of memory A in memory A'. The odd numbered 500 points out of the 1001 points of trace A are transferred to memory A', and the even numbered 501 points of trace A are left in memory A.

Be sure to press  or  before pressing .

(2) MAX.

In the MAX. mode the maximum signal response is held and displayed. At the end of each sweep, the new data is compared with old data in memory at each 1001 point and a larger signal response is stored in memory.



Operation of   selects the MAX. A mode and the MAX. indicator lamp lights. Operation of   selects the MAX. B mode.

The MAX. mode can be cleared by pressing the WRITE, VIEW or BLANK key for the pertinent memory.

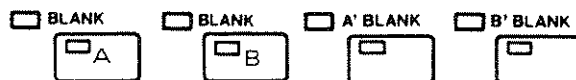
(3) BLANK



Unnecessary traces can be blanked from the CRT by using BLANK keys.

To blank trace A from the CRT, press   to place memory A in the BLANK mode.

Since the contents of the memory are saved in the BLANK mode, they can be recalled on the CRT by pressing the VIEW key. The BLANK mode can be selected for memories B, A', and B' in much the same way.

If the BLANK key is pressed in the WRITE mode, updating of the memory is no longer made and the current memory data is saved, with the CRT blanked out.



If the BLANK key is pressed in the VIEW mode, a frozen trace is blanked from the CRT and is saved in memory.



The BLANK mode can be cleared by pressing the VIEW, WRITE or MAX. key.

If the VIEW A key is pressed in the BLANK A mode, the saved trace is recalled on the CRT. This procedure can be applied to memories B, A', and B' as well.

If the WRITE A key is pressed in the BLANK A mode, the analyzer is placed in the WRITE A mode and the saved memory data is erased from memory A, and the signal response is written into the memory at the sweep rate and then transferred to the CRT (same for memory B as well).

As mentioned earlier, when VIEW A' mode is selected with

  , only the even numbered 500 points (out of

1001 points) of trace A are transferred to the CRT. To display the full 1001 points of trace A again, press   to blank trace A' from the CRT, then press the WRITE A key.



(4) Trace exchange



 exchanges the contents of trace memories A and B. The contents of memories A' and B' are also exchanged at the same time.



(5) Trace subtraction



a. A-B → A

 subtracts the contents of memory B from those of memory A. Memory B are subtracted from trace A from sweep to sweep and memory A or trace A and stores the result in memory A.

If  is pressed in the WRITE A mode, the contents of the resulting trace is displayed. The indicator lamp on the  key lights to indicate the A-B → A mode.

If  is pressed in the VIEW A mode, the contents of memory B is subtracted from frozen trace A and the result is written into memory A and then transferred to the CRT. The indicator lamp on the  key momentarily lights and memory A remains in the VIEW A mode.

If  is pressed in the WRITE B mode, memory B is placed in the VIEW B mode and the contents of memory B are subtracted from those of memory A and the result is written into memory A. The indicator lamp on the  key momentarily lights.

  selects the A-B → A mode, and  clears the A-B → A mode to return the analyzer to the normal WRITE A mode.

b. B-DL → B

First place memory B in VIEW B mode. Then, press . The display line level (to be described later) is subtracted from the contents of memory B (amplitudes at each point). If B-DL → B is pressed in the WRITE B mode, memory B is placed in VIEW B mode.

(6) Markers on memories A, B, A' and B'

If the WRITE or VIEW key for memory A or B or the VIEW key for memory A' or B' is pressed when an active marker is present on the CRT, the marker is repositioned to the memory for which the corresponding key is pressed. At this time the marker position on the horizontal graticule line remains unchanged. An inactive marker remains in its home memory even when one of the above keys is operated.

If one of memories A, B, A' or B' is placed in the BLANK mode, the marker for that memory is also blanked from the CRT. Marker repositioning is described below:

- Memory trace A (right) and memory trace B (left) are present on the display (see photo). Memories A and B are placed in the WRITE A and VIEW B modes respectively and an active marker is present on memory trace A.



WRITE



MARKER

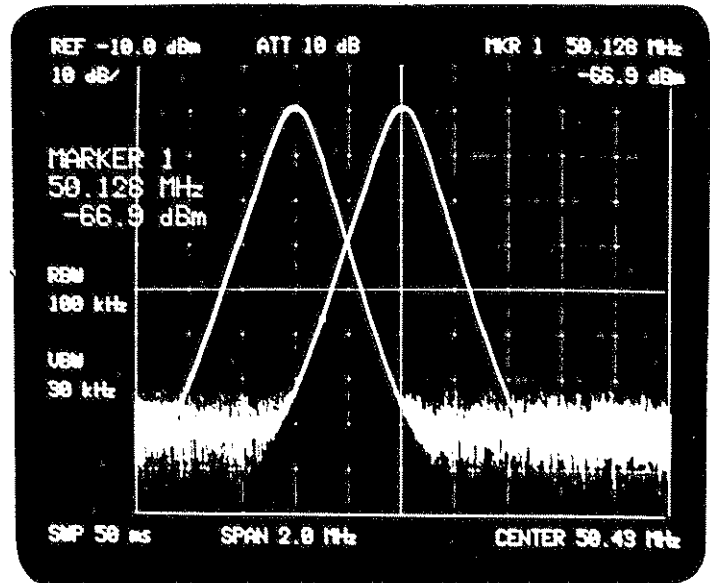

If the VIEW B key is pressed the active marker is repositioned on trace B.



VIEW

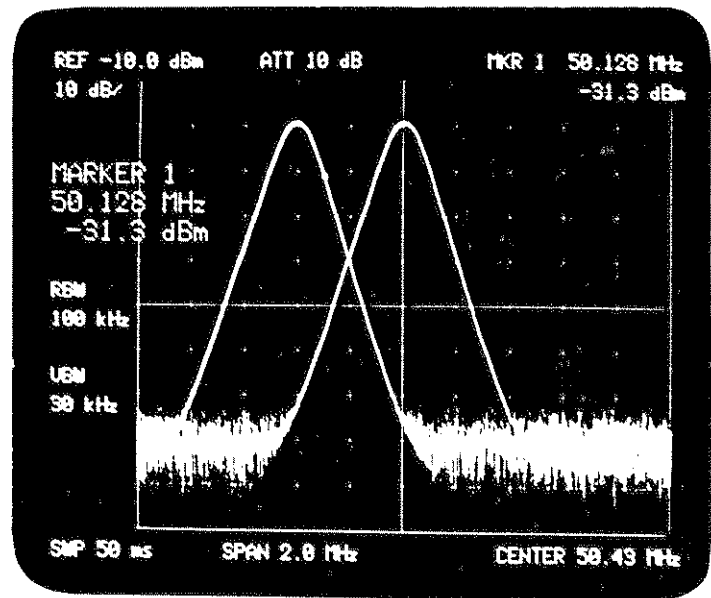

The marker moves on stationary trace B with the rotation of the DATA knob.

If the WRITE A key is pressed the marker is again repositioned onto trace A.

By utilizing this characteristic, differences in frequency and level between two traces can be read with a delta marker.

The reading procedure is described in the following:

First, activate a marker on a trace and position it to the desired position, then press . Press a trace key (e.g. B) to reposition the active marker on the other trace, then position it to the desired position on that trace.

The differences in frequency and level between the two traces are now read out. Note, however, that those frequency and level differences are calculated from the setup conditions (frequency span, dB/div., etc.) currently shown on the display.



4-10-2. Simultaneous Four Trace Display

An example of simultaneous four trace display using the 50 MHz CAL. signal is given below.

- (1) Press the AC key for INPUT-1. Connect the CAL. OUT. connector to the INPUT-1 connector with input cable MI-02 (with the N-BNC plug adapter attached to INPUT-1).
- (2) Set the center frequency to 50 MHz. The CAL. signal will appear at the center of the display.

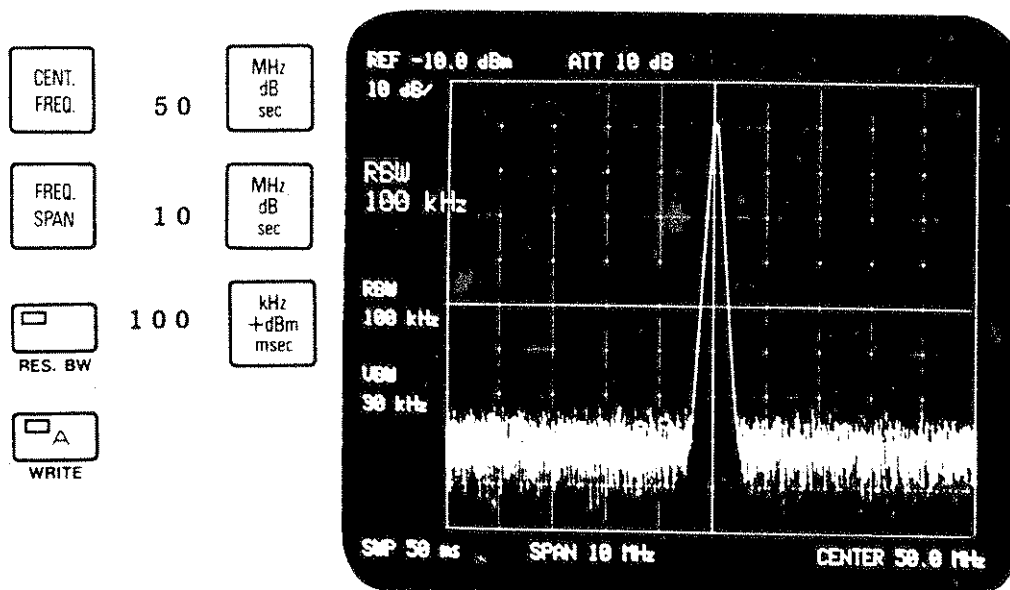
Set frequency span to 10 MHz and resolution bandwidth to 100 kHz. Press the WRITE A key.



- (3) Press  and  . The contents of memory A is transferred to memory A'. Traces A and A' cannot so far be discriminated from each other since the contents of memories A and A' are identical.
- (4) Press the **FREQ. SPAN** key and then turn the **DATA** knob slightly counterclockwise to enlarge the trace. Now active trace A can be discriminated from frozen trace A' on the display.



A' VIEW



SHIFT



A → A'



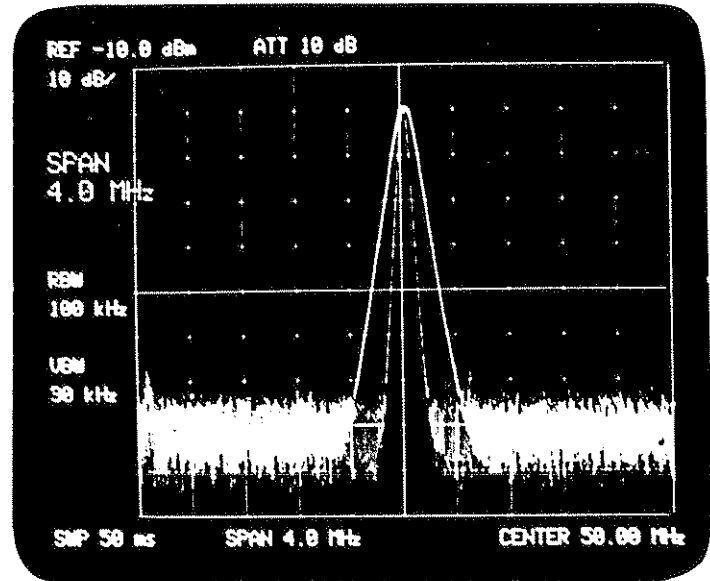
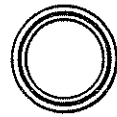

FREQ.
SPAN

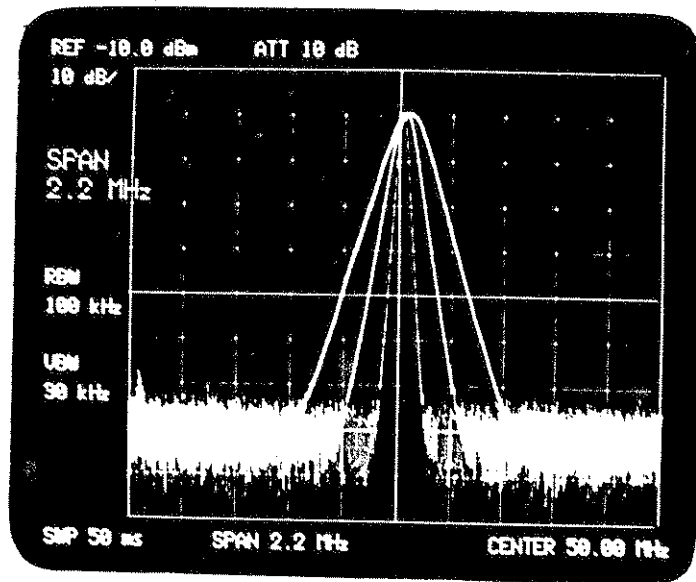
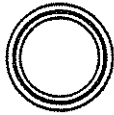

- (5) Press the **WRITE B** key. Memory A is automatically placed in the **VIEW A** mode and trace A is frozen. Memory B can now be updated. Turn the **DATA** knob to enlarge trace B. Now three traces B, A, and A' are displayed.



- (6) Press   to transfer the contents of memory B to memory B'. Trace B cannot be discriminated from trace B' since the contents of memories B and B' are identical.
- (7) Turn the DATA knob slightly counterclockwise to discriminate trace B' from trace B. Now four traces are displayed on the CRT at a time.

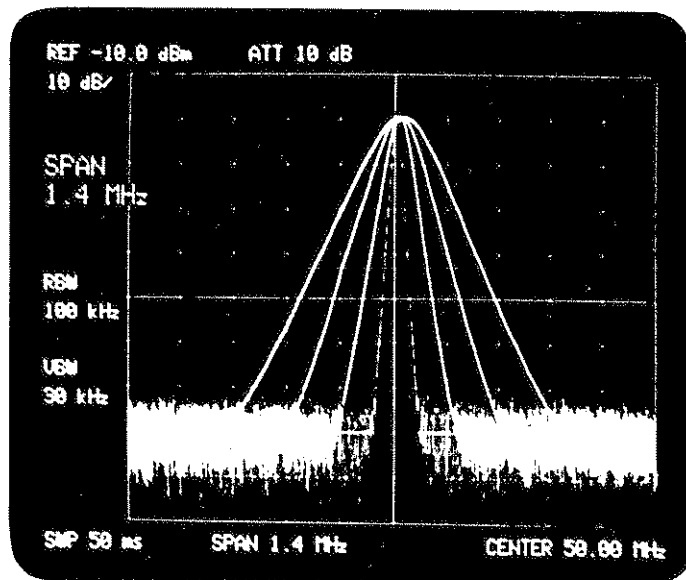
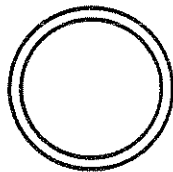

(8) Use the BLANK key to blank unnecessary trace from the display:

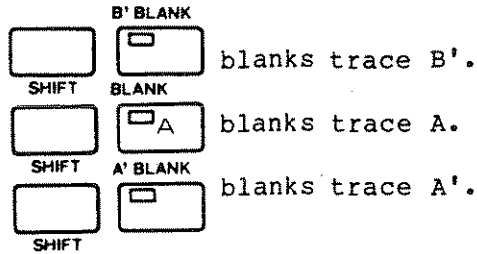

To recall a blanked trace on the CRT, press the VIEW key (e.g.



(9) If contents of trace A and trace B are desired to be exchanged under simultaneous four trace display preserving trace A' and trace B' as it is, it can be performed by the following operation.

Specify traces A, A', B, and B' to VIEW mode, and then press



Note that traces A and B, and traces A' and B' are exchanged

simultaneously, if key is depressed.



4-11. TRIGGER

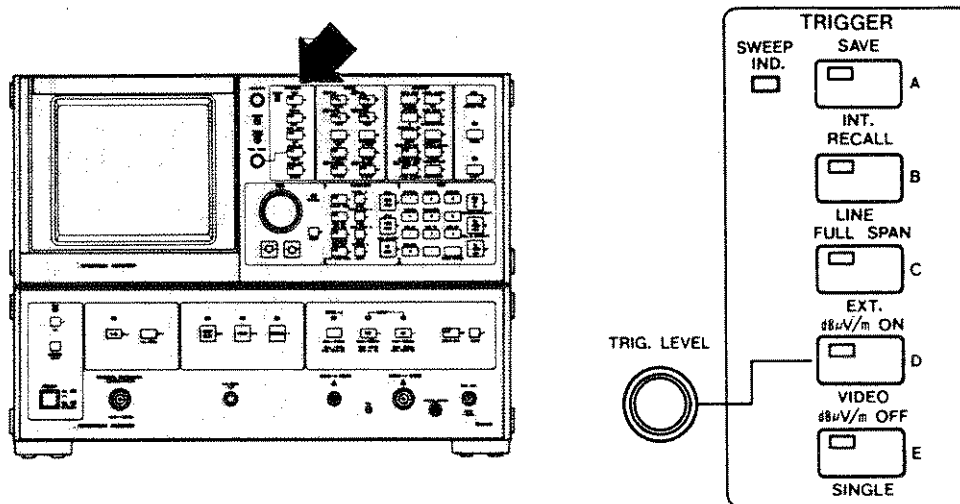

The analyzer sweep is triggered by selection of one of five modes.

(1) INT.



Automatically repeats internal triggering.

(2) LINE



Repeats triggering in synchronism with the line frequency.

(3) EXT.



Allows the next sweep to start in synchronism with an external trigger signal (TTL compatible) supplied to the rear EXT. TRIG. connector. Triggering occurs at a HIGH to LOW transition of the external signal.

(4) VIDEO



Allows the next sweep to start if the detected IF envelope voltage rises to a level set by the TRIG. LEVEL knob. If the trigger fails, adjust the TRIG. LEVEL knob.

(5) SINGLE



Allows the next sweep each time the SINGLE key is pressed.

(6) Trigger mode selection

One of the above five trigger modes should be selected. The indicator lamp on the selected key will light. Normally, set the trigger mode to INT.

4-12. DISPLAY LINE AND LABEL

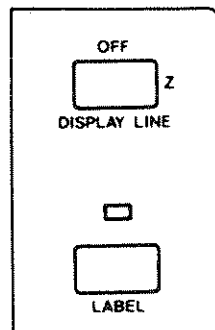

4-12-1. DISPLAY LINE

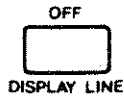

activates a display line (horizontal cursor line) on the display.

The display line can be positioned anywhere within the graticule by the DATA knob or DATA step keys. The display line level is read to the left side of the CRT as "DISPLAY LINE XX dBm". The same readout is always presented at the bottom left corner of the display as "DL XX dBm". The peak level of a signal response trace can be easily read out by positioning the display line to that peak level. The DATA step keys move the display line one tenth of the total amplitude scale per step. The DATA knob moves the line in display unit increments for finer control.

erases the display line from the CRT display but does not reset the last position. If the display line is activated again with , it will return to its last position.

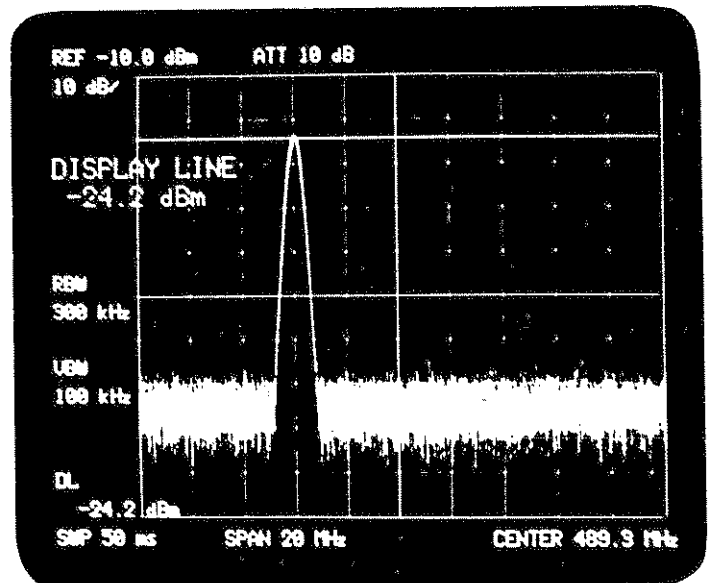

4-12-2. LABEL



selects the LABEL entry mode; the indicator lamp just above the key lights, a cursor (-) appears on the CRT, and the front panel keys have functions different from those in the normal mode.

The LABEL mode permits entry of optional alphanumeric characters in the top area of the CRT display. The green letters presented beside each key are entered in this mode. Up to 54 characters can be entered per line. The DATA keyboard can be used for entry of numerical characters.

A space can be created between characters by pressing the  key in the DATA section. If an entry error is made, press the BACK SPACE key on the DATA keyboard.



The last character will be erased and the cursor will backspace one character position.

When entry of a label is completed, press the SHIFT key. This will clear the LABEL entry mode and return the front panel keys to their normal functions; the indicator lamp above the LABEL key goes off. An entered label can be edited by deletion or insertion. For label editing, place the analyzer in the LABEL entry mode by pressing the LABEL key. The cursor position can be controlled with the DATA knob. To delete a label character, position the cursor to the

character with the DATA knob and then press  once. To insert characters, position the cursor to the character location at which insertion begins and then press . A space of five consecutive character locations will appear at and beyond the cursor position. Each time a character is inserted into this space, the five character space moves to the right by one character location. When insertion is completed, press  again.





A character at the cursor position can be overwritten. The old character at the cursor position is overwritten with a new character.

A character string entered in the LABEL mode can be cleared with

 . It is also cleared when the MASTER RESET key is pressed or the device is switched to the STANDBY state.

4-13. SAVE AND RECALL



Up to 8 key statuses can be saved in internal registers and recalled as needed. To save the current key status press  , then press a numerical key between 1 and 8. The key status is saved in the register with the corresponding number. The saved key status can be recalled by pressing   and then the number key which corresponds to the register number from which the key status is to be recalled. When recalled, the current key status will be replaced with the saved key status.

The register contents remain intact even when the POWER switch is set to STANDBY. If the power cables of the instrument are unplugged from the outlets, the internal back-up battery maintains the register contents for about two weeks.

A label (character string entered in the top area of the CRT display) cannot be saved, nor can marker, trace, signal responses, or display line.

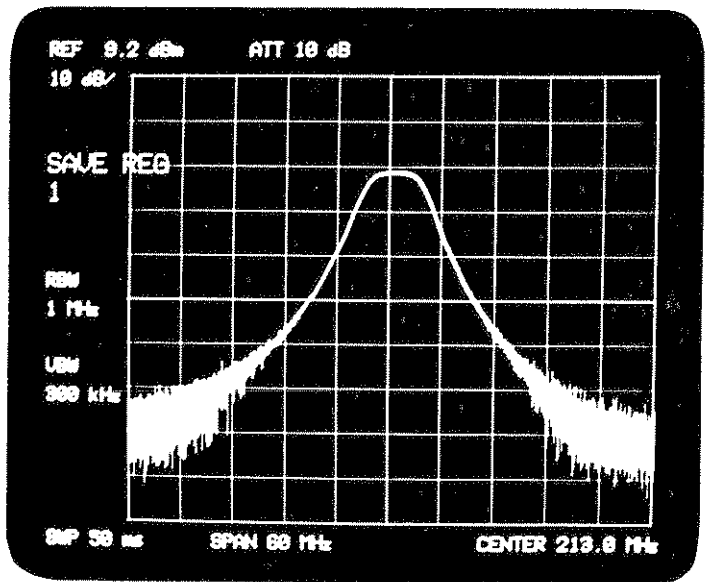



MASTER
RESET

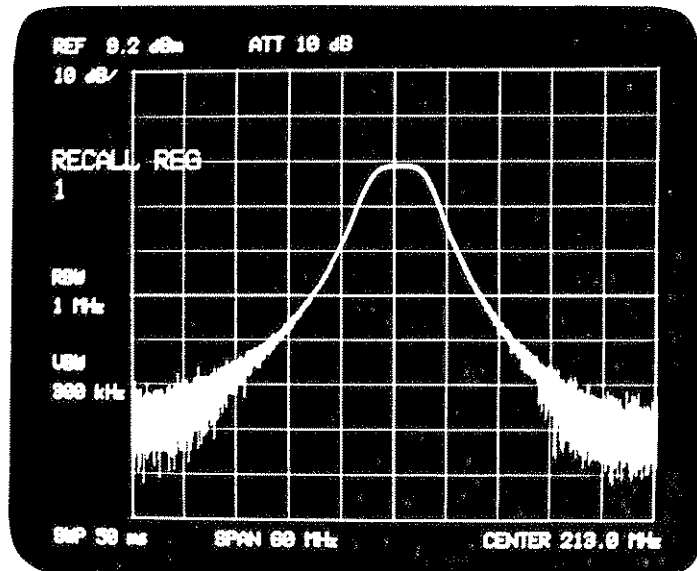
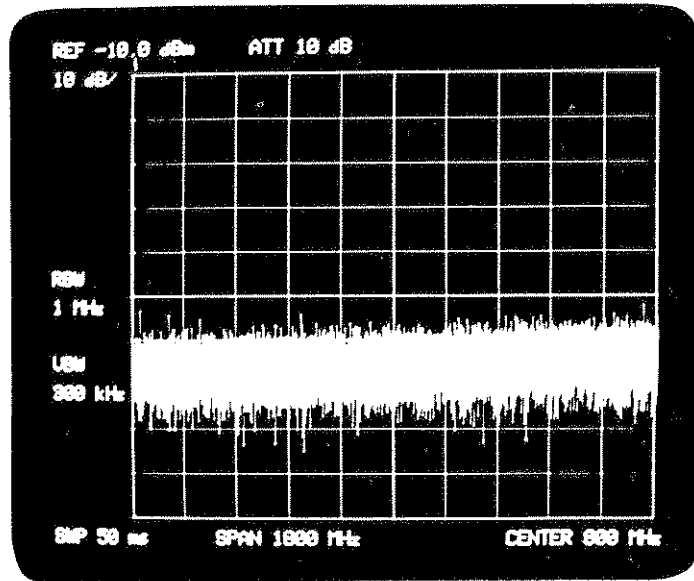

Save Registers 0 and 9 are also available as well as 1 through 8. However, the contents of Save Registers 0 and 9 may be changed when the MASTER RESET key is pressed, the power is turned off or the Error Correction Routine is executed or an optional function is executed.

4-14. SHIFT



When the SHIFT key is activated, a key operated immediately after the SHIFT key provides supplemental or unique measurement capability indicated by yellow characters above each key. Some keys require the double shift operation for which the LABEL key must be pressed after the SHIFT key is operated, such as



The double-shift key functions include service switches. If the TR4172 malfunctions as a result of inadvertent activation of a service double-shift key sequence, press switches. If the TR4172 malfunctions as a result of inadvertent activation of a service double-shift key sequence, press switches. If the TR4172 malfunctions as a result of inadvertent activation of a service double-shift key sequence, press the MASTER RESET key. The appendix contains a listing of the double-shift key functions.

This paragraph covers the description of the shift key functions hitherto not covered in the preceding paragraphs.

4-14-1. Video Averaging (AVG.)

In the Video Averaging mode, signal response data is averaged while it is weighted in the time domain. Averaged data are added to new data under a certain weight by the preset number (N). Averaging is effective only in the WRITE A mode.

The Video Averaging mode allows a good signal-to-noise ratio without long sweep time.



The Video averaging of each amplitude point on the frequency axis is given by the following equation:

$$\bar{y}_n = \frac{n-1}{n} \bar{y}_{n-1} + \frac{1}{n} y_n \quad (n \leq N)$$

where y_n : n'th data

\bar{y}_n : n'th averaged data

\bar{y}_{n-1} : (n - 1)th averaged data

To activate video averaging, press   ; video averaging is immediately started.

The number of averaging is read to the top left corner of the display as "AVR XX", and the programmed number of averagings is read to the active function display area. (These readouts disappear when another function key is pressed.)

When the programmed number of averagings (N) is reached, $\frac{n-1}{n}$ and $\frac{1}{n}$ in the above equation are fixed to $\frac{N-1}{N}$ and $\frac{1}{N}$ respectively.

Averaging for n = N is performed according to the following equation (however, the current averaging number readout on the display stops at n = N):

$$\bar{y}_n = \frac{N-1}{N} \bar{y}_{n-1} + \frac{1}{N} y_n$$

When the analyzer is initially switched on, the number of averagings is preset at 128. To modify this number, enter the desired number (2^n :64 for instance) from the DATA keyboard and then press one of the units keys. This technique allows programming of up to 4096 averagings. Averaging sequence temporarily stops and then restarts.

To disable averaging press m.

SHIFT CF STEP SIZE

Do not change the analyzer's settings such as center frequency or frequency span while performing the video averaging. To change those settings, first stop the video averaging, then change those function settings, next restart the video averaging.

4-14-2. FULL SPAN (SHIFT C)

C sets center frequency to 900 MHz and frequency span to full 1800 MHz.

SHIFT FULL SPAN

4-14-3. DETECTION (SHIFT n, p, s, z)

One of four detection techniques can be selected for displaying trace information.

(1) Normal Detection mode n

SHIFT NORM. D.

The normal mode is initially selected when the analyzer is switched on. The positive and negative peak values are displayed alternately at each point on the frequency axis.

- (2) Positive Peak Detection mode ^{POSIT. PEAK D.}
SHIFT

The positive peak detection mode displays signal maximums for the time period at each point on the frequency axis.

"POS PK" is read in the active function display area.

- (3) Negative Peak Detection mode ^{NEG. PEAK D.}
SHIFT

The negative peak detection mode displays signal minimums for the time period. "NEG PK" is read in the active function display area.

- (4) Sample Detection mode ^{SAMPLE D.}
SHIFT

In the Sample Detection mode, the instantaneous signal value of the final analog-to-digital conversion for the time period is displayed. "SAMPLE" is read in the active function display area. When the Averaging mode is selected, the Sample Detection mode is automatically selected.

4-14-4. REF. OFFSET

Any desired offset value can be applied to the reference level of this unit. First press the and ^{REF. OFFSET} keys, and then key in the offset value [XX dBm] using the DATA keyboard. If a negative unit offset value is required, press the ^{Hz} ^{-dBm} ^{µsec} switch after keying in the numerical value.

The input offset value is displayed constantly in the bottom left hand corner of the screen in the "OFFSET XX dB" format. Subsequent reference level, marker, and display line displays appear with this offset value added (or subtracted if a negative offset).

Offset input is still possible when the reference level is displayed in [dBµ]. In this case, press the ^{kHz} ^{+dBm} ^{msec} or ^{Hz} ^{-dBm} ^{µsec} switch after keying in the numerical offset value.

Reference level offset is cancelled and the offset value reset to zero by pressing the ^{REF. OFFSET} ^{REF. LEVEL} ⁰ , and ^{kHz} ^{+dBm} ^{msec} switches.

4-14-5. Electric Field Strength Measurement

① Connect an antenna to the TR4172 input terminal (50 Ω), noting that the antenna impedance must be 50 Ω. If not, achieve impedance matching by using a matching circuit.

② Set the center frequency and frequency span.

③ Press and ^{dBμV}
SHIFT FREQ. SPAN, to set the level unit to dBμV.

④ Press the _{MARKER} switch to obtain a marker output in the screen, and adjust the marker to the frequency spectrum to be measured.

⑤ The relation between the marker point display level, that is, the TR4172 input terminal voltage e_x (dBμV), and the actual electric field strength (dBμV/m), is given by the following expression.

$$E_x = e_x + K$$



where K is an antenna coefficient (dB)

⑥ When the ADVANTEST TR1722 half-wavelength dipole antenna is used, the above antenna coefficient K can be corrected for automatically.

Press and ^{dBμV/m ON}
SHIFT VIDEO. The marker unit is changed to dBμV/m, and the electric field strength E_x corrected for antenna coefficient K can be read directly. Note, however, that this calibration requires that the supplied 5D2W 10 m cable be used. Use of any other cable will result in the introduction of error.

⑦ If the ADVANTEST TR1711 logarithmic periodic type antenna is used, press the and ^{dBμV/m ON}
SHIFT VIDEO keys. The E_x value will be a value obtained by subtracting 5 from the displayed value in dBμV/m).

If ^{REF. OFFSET}
SHIFT REF. LEVEL, , and ^{Hz}
-dBm μsec are pressed, an offset of -5 dBm is applied to the reference level. This means that the marker value can be read directly as the E_x (dBμV/m) value. In this case, too, calibration is dependent on the use of the 5D2W 10 m cable supplied. The use of any other cable results in the introduction of error.

- ⑧ When  and  are pressed, the marker electric field strength measurement is cancelled, and the marker unit is made uniform with the reference level.
- ⑨ If other antennas apart from TR1722 and TR1711 are used, calibrate with the following equation.

$$\begin{aligned}
 E_x &= (e_x + 6) + L_a - H_e + B_a \\
 &= e_x + K
 \end{aligned}$$

where H_e (dB) is the effective antenna length,

L_a (dB) is cable loss,

B_a (dB) is balun loss, and

K (dB) is the calibration coefficient.

The calibration coefficient for half-wavelength dipole antennas is determined from the following equation.

$$K = 20 \log \frac{\pi}{300} F + 6 + L_a + B_a$$

where F is the reception frequency (MHz)





$$= -33.6 + 20 \log F + L_a + B_a$$

If a wide-band arithmetic periodic type antenna is used, subtract the antenna gain (half-wavelength dipole antenna ratio).

4-14-6. SAVE Register Alternate Sweep-1



When SAVE registers 1 and 2, and WRITE A mode and WRITE B mode are used, measurement based on two independently set conditions can be executed alternately, and the results of both measurements can be displayed simultaneously in the screen. The procedure involved is described below. In the examples shown here, the vertical axis scale is set to 10 dB/div. and 2 dB/div.

- ① With the instrument in the initialized state, press the  switch to select WRITE A VIEW B mode where the first measuring condition is set. The vertical axis scale in the initialized state is 10 dB/div.
- Set the center frequency and the frequency span.
- ② Press , , and  to store the first measuring condition in SAVE register 1.

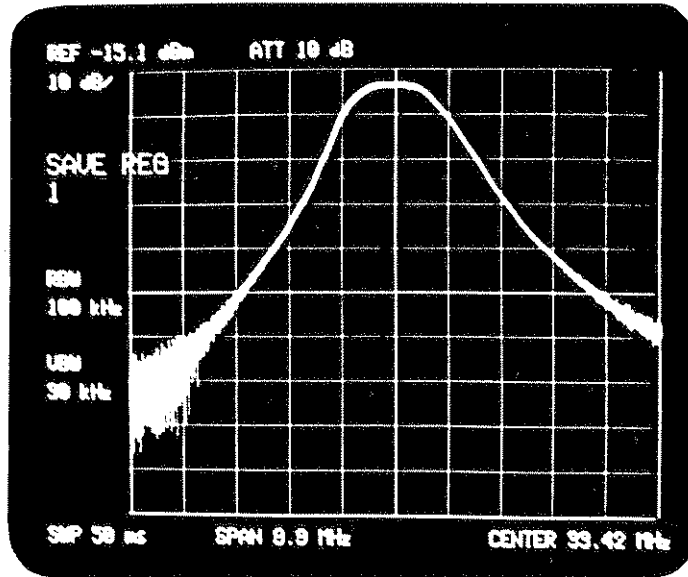
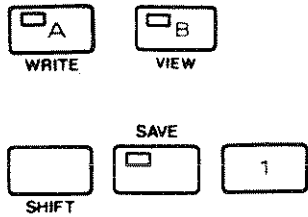

- ③ Then press the B WRITE switch to select WRITE B VIEW A mode. The vertical axis memory is changed to 2 dB/div. by pressing SHIFT and 9.
- ④ Although other measuring conditions can be varied as desired, do not change CENT. FREQ or FREQ. SPAN. If change to either of these functions is desired, refer to the following Save register alternate sweep - 2 procedure.
- ⑤ Press SHIFT, SAVE, and 2 to store the second measuring condition in Save register 2.

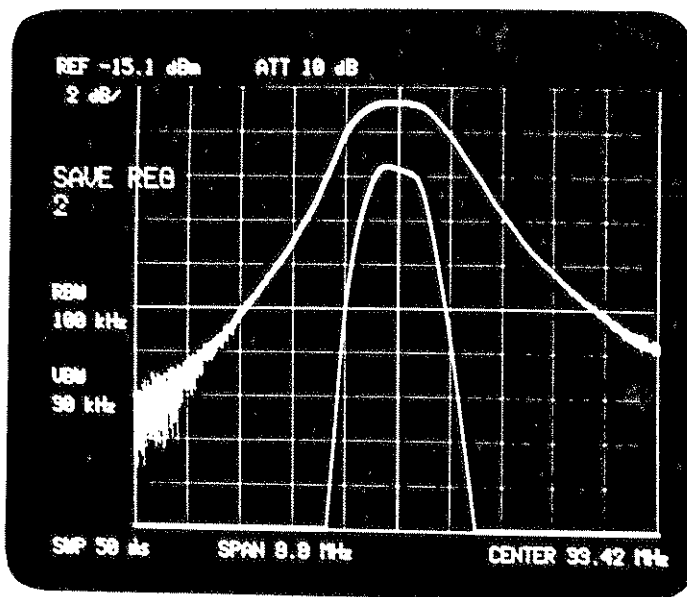
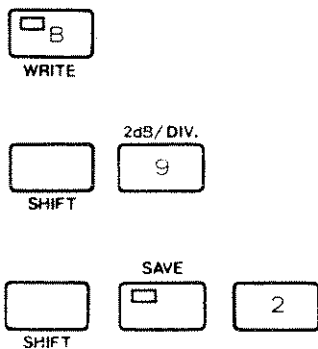

⑥ The alternate sweep mode is selected by pressing , , and . SAVE register 1 A and SAVE register 2 B are recalled alternately at each sweep, and are displayed simultaneously in the screen.

The LED Indicator lamps in the A and B switches come on alternately to indicate the alternate sweep mode.

If a short sweep time is selected, the readouts may be difficult to read because they change at a relatively high rate.

The Alternate sweep mode can be disabled by pressing any key.

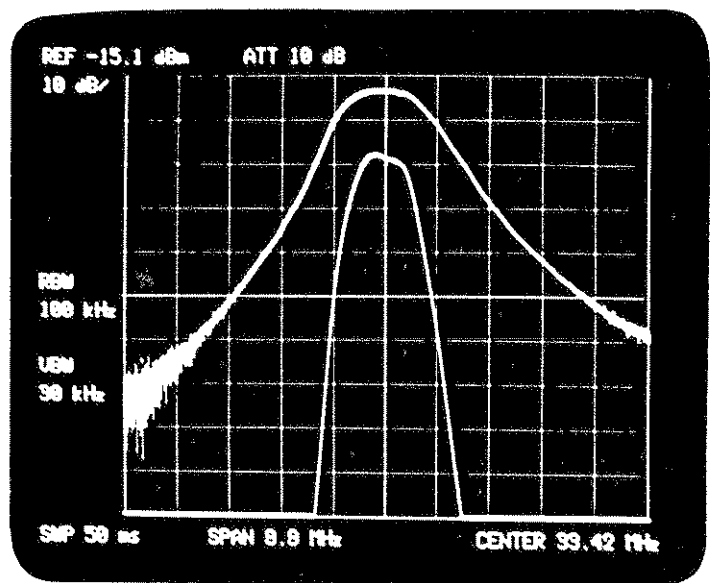

4-14-7. SAVE Register Alternate Sweep-2



In addition to the functions saved in the SAVE register alternate sweep-1 mode, different center frequency and frequency span data can be saved in SAVE registers 1 and 2 in the SAVE register alternate sweep-2 mode. The required save method is identical to that for the SAVE register alternate sweep-1 mode. In the alternate sweep-2 mode, the display writing rate may be lower than that in the alternate sweep-1 mode.

4-14-8. Logarithmic Scaling for Frequency (Log Display)

After blanking the B and B' traces, pressing places the horizontal graticule in the logarithmic scale. The center frequency and frequency span readouts disappear from the display and, instead, a START frequency (frequency at the left most graticule) and a STOP frequency (frequency at the right most graticule) are read out. The START frequency is selected from 100 Hz, 1 kHz, 10 kHz, 100 kHz, and 1 MHz so that the center frequency on the linear scale is positioned near to the center of the display. Since the frequency span covers three decades, a STOP frequency is 1000 times as large as a START frequency. For instance, when the center frequency is between 100 kHz and 900 kHz, the START and STOP frequencies are 10 kHz and 10 MHz respectively.

The analyzer can be returned to the linear mode by operating any key except the key for plotting. (See Section 8-15.)

A log display example is given below.

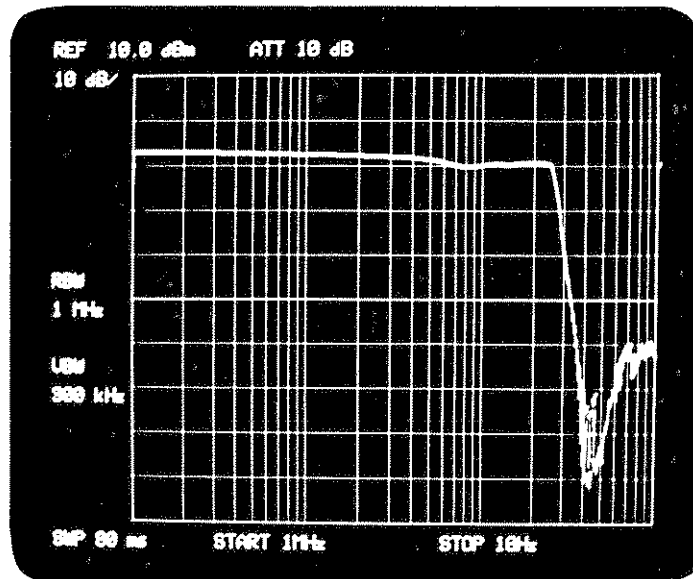

When observing noise waveform, press to select the sample detection mode before entering the log. display mode. When the RES. BW. key is in the AUTO mode, a constant resolution bandwidth may not be selected over the three decades. To obtain a constant resolution bandwidth over the three decades, press the RES. BW. key to select MANUAL mode and select desired resolution bandwidth in MANUAL mode before entering log. display mode.

Logarithmic scaling trace in memory A can be stored by operating keys



. If the HOLD key is pressed to return to linear scale mode, information of logarithmic scaling trace except vertical graticule stored in memory B is saved. Press the key Q when plotting by TR9834R is desired.

4-14-9. Error Correction Routine

The error correction routine is for upgrading of measurement accuracy. This is done by correcting the previously-obtained correction factor at the time of actual measurement, when the routine is executed on TR4172. The following items are measured by the error correction routine using TR4172:

- absolute level error at the time of switching the resolution bandwidth between 7 Hz and 1 MHz
- vertical linearity of the screen for log 10 dB/DIV., 5 dB/DIV., 2 dB/DIV. and 1 dB/DIV.

Set the POWER switch ON and warm up for more than one hour. Attach the N-BNC adapter to the INPUT-1 connector and TRACKING GENERATOR OUTPUT connector and then interconnect both connectors with the attached input cable MI-02. Pressing W activates the error correction routine to measure log linearity first with "CALIBRATING LOG LINEARITY" displayed on the screen.

The following message will appear if neither connectors are connected:

PLEASE CONNECT T.G. OUTPUT TO INPUT-1

CONTINUE OR QUIT < 0 OR 1 >

Error correction is possible if key , from the ten keys, is pressed after making proper connection between two connectors with MI-02. Pressing key here will result in normal condition.

The following message will displayed on the screen when log linearity measurement is completed:

PLEASE CONNECT CAL.OUT. TO INPUT-1

AND PUSH ANY KEY

When the above message is displayed, remove the cable which connects the TRACKING GENERATOR OUTPUT connector and INPUT-1 connector and interconnect the CAL.OUT.connector and INPUT-1 connector with the attached cable MC-61.

The measurement of absolute level errors at the time of resolution bandwidth switching will start if an arbitrary key is pressed with "CALIBRATING SWITCHING BETWEEN" displayed after completing the above operation.

When all error corrections are completed, the display at the left center on the screen disappears and the state before entering into the error correction routine is recovered.

The user can display a list of corrected values of resolution bandwidth which were stored in the memory by pressing X. Confirm that all values fall with in a range of +3 dB. Normal display is recovered by pressing an arbitrary key.

When corrected values exceed a range of +3 dB, adjust by turning the CAL control knob - a fine adjustment control knob for IF gain - on the front panel. Turning the knob clockwise will decrease the level on the screen while turning counterclockwise will increase it.

After this adjustment, execute the error correction routine again to confirm, on the displayed, list that all the corrected values fall within a range of +3 dB. The corrected values once stored into the memory cannot be erased by pressing MASTER RESET key or by setting POWER switch to STANDBY. The stored values are retained for approx. two weeks with the aid of built-in Ni-Cd cells even if the power cable is disconnected.

When measurement without the calibrated values is required, press



SHIFT



LABEL



Y, and the following message will be displayed:

CAL. ON NOW

'1' CAL. ON

'2' CAL. OFF

Error correction will not be made if key 2 , from the ten keys, is pressed. Pressing key 1 , from the ten keys, will result in the error correction mode in which the previously obtained factors will be used.

4-15. QP Measurement Mode

4-15-1. Outline

QP measurement mode is used to measure impulsive noise. As indicated in Table 4-2, the various constants used in the measurement comply with the values prescribed by CISPR standards.

Table 4-2 CISPR standards concerning basic QP measurement characteristics

	Frequency range	6 dB BW	Charging time constant	Discharging time constant	Mechanical time constant
A	10 kHz to 150 kHz	200 Hz	45 ms	500 ms	160 ms
B	150 kHz to 30 MHz	9 kHz	1 ms	160 ms	160 ms
C	30 MHz to 300 MHz	120 kHz	1 ms	550 ms	100 ms
D	300 MHz to 1 GHz	120 kHz	1 ms	550 ms	100 ms

4-15-2. QP value measurement

- ① Set the center frequency and the desired frequency span.
- ② Press and increase or decrease input attenuation with the DATA knob or step keys, 10 dB at a time, while observing the waveform on display.
- ③ Check that the waveform level does not vary. If it varies, input to the TR4172 is saturated. To avoid saturation, increase input attenuation or insert a bandpass filter or equivalent in the input circuit.
- ④ If no variations in the waveform level have been verified, change the reference level with REF. LEVEL to set the output peak level 20 dB to 30 dB down from the top of the screen before entering a QP measurement mode listed in Table 4-3.

Table 4-3 QP measurement modes

Frequency range		6 dB BW	QP measurement		
A	10 kHz to 150 kHz	200 Hz	<input type="checkbox"/> SHIFT	<input type="checkbox"/> LABEL	<input type="checkbox"/> j
B	150 kHz to 30 MHz	9 kHz	<input type="checkbox"/> SHIFT	<input type="checkbox"/> LABEL	<input type="checkbox"/> k
C,D	30 MHz to 1 GHz	120 kHz	<input type="checkbox"/> SHIFT	<input type="checkbox"/> LABEL	<input type="checkbox"/> m
To cancel QP measurement mode,			<input type="checkbox"/> SHIFT	<input type="checkbox"/> LABEL	<input type="checkbox"/> z

- ⑤ QP measurement involves the use of long time-constant circuits as shown in Table 4-2, requiring sufficiently long sweep time settings. As a general rule, set a sweep time of 1 second/200 Hz in frequency range A (10 kHz to 150 kHz), to 1 second/10 kHz in frequency range B (150 kHz to 300 MHz), and to 1 second/100 kHz in frequency ranges C and D (30 MHz to 1 GHz).

For example, the sweep time should be set to 50 seconds if measuring in a frequency range with a frequency span of 10 kHz.

- ⑥ After setting the sweep time, press the MARKER switch to output a marker. The level at the marker point is represented in dBμ, indicating the QP value of the input terminal at the marker-point frequency.

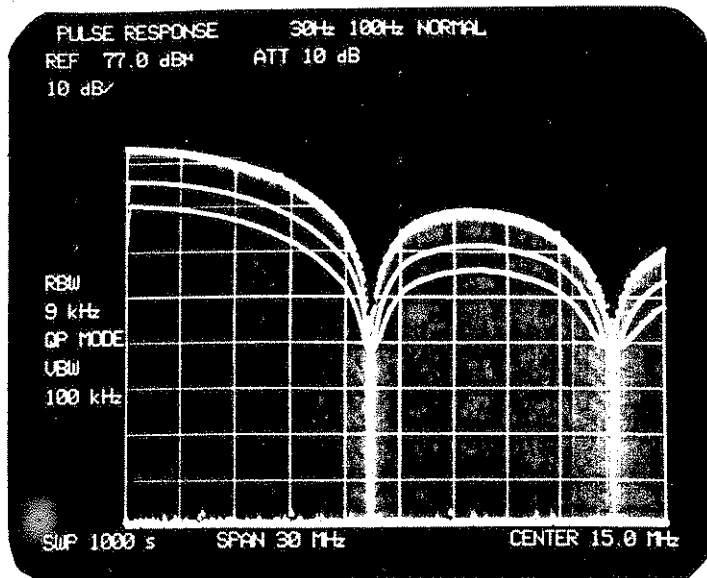

- ⑦ Press , when a ADVANTEST TR1722 half-wavelength dipole antenna is used.

This key-in sequence automatically corrects the antenna coefficient to represent the marker point level in dB μ V/m, permitting the QP value to be read directly.

- ⑧ With a ADVANTEST TR1711 logarithmic-period antenna, press to enter an offset of -5 dB in the reference level.

Again, the antenna coefficient is automatically corrected, enabling direct reading of the QP value. (It is displayed in dB μ .)

- ⑨ The automatic correction for the TR1722 and TR1711 antennas assumes the use of the supplied 10m 5D2W cable.

Use of any other cable might produce an error in antenna coefficient correction.

- ⑩ If a different antenna is used, calculate the QP value by determining the correction coefficient with reference to 4-14-5. "Electric field strength measurement."

- ⑪ To cancel the QP measurement mode, press z.

4-15-3. QP BW Check

6 dB BW (bandwidth) of CISPR standards listed in Table 4-2 can be verified by following the procedures given below.

- ① Connect the CAL. OUT signal to the INPUT-1 connector of RF section, and set the center frequency to 50 MHz by operating

keys .

- ② Set the frequency span, depending on which of frequency ranges A to D has been set, as indicated in Table 4-4.

Table 4-4 QP BW check

Frequency range		6dB BW	Frequency span	QP BW check mode
A	10 kHz to 150 kHz	200 Hz	2 kHz	<input type="button" value="SHIFT"/> <input type="button" value="LABEL"/> <input type="button" value="M"/>
B	150 kHz to 30 MHz	9 kHz	10 kHz	<input type="button" value="SHIFT"/> <input type="button" value="LABEL"/> <input type="button" value="N"/>
C, D	30 MHz to 1 GHz	120 kHz	1 MHz	<input type="button" value="SHIFT"/> <input type="button" value="LABEL"/> <input type="button" value="O"/>
To cancel QP BW check mode,				<input type="button" value="SHIFT"/> <input type="button" value="LABEL"/> <input type="button" value="AUTO"/>

After entering the frequency span, execute one of the QP BW check modes, depending on which of frequency ranges A to D has been set, as indicated in Table 4-4.

- ③ Freeze the spectrum by pressing key, and then press

Specifications are as shown below.

- A) 200 Hz \pm 20 Hz
 B) 9 kHz \pm 1 kHz
 C, D) 120 kHz \pm 20 kHz

4-16. X-Y RECORDER OUTPUT (OPTION 03)



This optional output provides signal response and graticule information (display line and markers are not included) to an X-Y recorder. The information on the display is subject to digital-to-analog conversion and coupled to the X, Y, and Z connectors on the rear of the instrument in the form of analog signals. The usage of this optional output is explained in the following:

First, connect the TR4172's rear X, Y, and Z connectors to the X, Y, and Z inputs on the X-Y recorder respectively.



Each output has an output voltage range of 0 V to approximately +5 V. The Z output provides pen up/down control: 0 V for pen up, and approximately +5 V for pen down. While the initial default setting for the Z output for pen lift control is 0 V for pen up and approximately +5 V for pen down, this condition can be reversed by key operation. If the Z output does not match the specification of the X-Y recorder used, use the Pen Lift switch on the recorder for pen up/down control.

The necessary key operations for the optional output are described below:

(1) X-Y recorder output mode

Press    to select the X-Y recorder output mode. Message "X-Y RECORDER" will be shown in the active function display area of the screen. In this mode each front panel key has functions different from those used for normal measurement. To clear the X-Y recorder mode, press the SHIFT key.

(2) Setting the image size and position

To set up the size and position of the output image on the X-Y recorder, press the  key. This will lift the recorder's pen and move it to the lower left home position. Message "LOWER LEFT" will be shown in the active function display area of the screen. Operation of the  key lifts the pen and moves it to the upper right home position. Message "UPPER RIGHT" will be shown in the

active function display area of the screen.

Determine the size and position of the output image on the recorder by adjusting the gain and offset of the recorder while operating these two keys.

- (3) All trace and scale output

Operation of the  key causes the X-Y recorder to record all traces (traces A, A', B and B') and graticule. After recording one trace, the recorder's pen lifts, returns to the lower left home position, and then starts recording the next trace or graticule. If the Z output (pen lift signal) of the TR4172 does not match the X-Y recorder specification, pen lift operation will not be done automatically. In this case, use (4) through (8) below, and manually lift the pen at the end of each trace output, press the



key to return the pen to the lower left home position, then lower the pen again before starting output of another trace or graticule.

- (4) Output of only the graticule

Press the  key to output only the graticule.

- (5) Trace A output

Press the  key to output trace A.

- (6) Trace B output

Press the  key to output trace B.

- (7) Trace A' output

Press the  key to output trace A'.

- (8) Trace B' output

Press the  key to output trace B'.

- (9) Holding recorder operation

If the  key is pressed, the X-Y recorder temporarily suspends

its operation with its pen lifted up. A second operation of the key restarts recorder operation from the hold point. If other trace key (e.g. A key) is pressed when the pen remains stationary, the pen will automatically return to the lower left home position and then start output of the trace selected with the trace key.

(10) Clearing the X-Y recorder output mode

To clear the X-Y recorder output mode, press the key.

(11) Recording speed selection

The frequency axis of the TR4172 usually consists of 1001 data points. Each of these points is subject to digital-to-analog conversion at approximately 100 ms sampling rate for the optional X-Y recorder output. This sampling rate can be varied between approximately 10 ms and 1000 ms with the key and DATA knob used together.

Operation of the key will show the current sampling rate "100 ms/POINT" in the active function display area of the screen. Use the DATA knob to change this active readout of sampling rate to the desired rate.

This newly specified sampling rate will be cleared into 100 ms/POINT and its readout will disappear from the active function display area when the X-Y recorder output mode is cleared with the SHIFT key operation.

(12) Pen up/down control setting

If the Z output of the TR4172 properly matches the pen control input of the attached X-Y recorder, operation of key will lift the pen, and operation of key will lower it. If the actual pen movement is the reverse of the above, reverse the polarity of the Z output according to the following instructions:

(13) Z output polarity reversal

If key is pressed, the Z output provides 0.0 V for pen-up and approximately +0.5 V for pen-down. At this time the message

"PEN UP/DOWN = LO/HI" is shown in the left information area on the display.

If key is pressed, the Z output provides approximately +5.0 V for pen-up and 0.0 V for pen-down. At this time the "PEN UP /DOWN = HI/LO" is shown in the left information area on the display.

4-17. WRITING UPPER AND LOWER LIMIT DATA

Upper and lower limit data can be written on the TR4172's screen directly from its front panel. This allows the operator to know whether the signal response trace in question falls within the limits or not at a glance (see Figure 4-1).

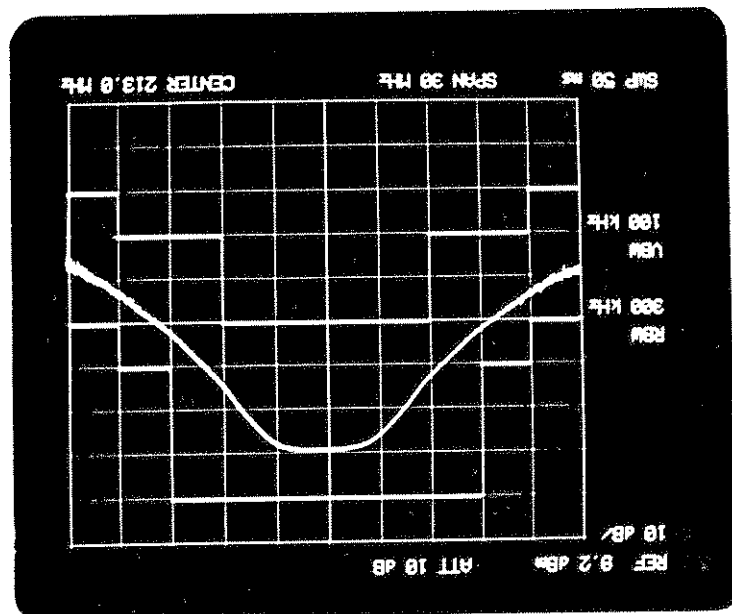





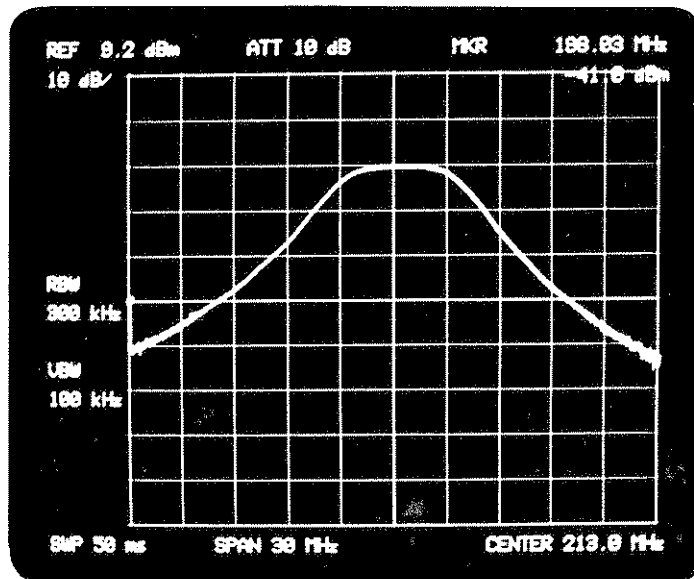
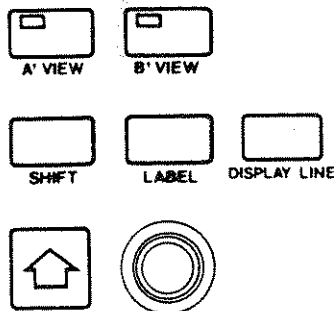





Fig. 4-1 Signal response observation with upper and lower limit data written on the screen

First write upper (or lower) limit data into memory A, then transfer the data to memory A'. Next, write lower (or upper) limit data into memory A, then place the analyzer in WRITE B mode for signal observation. More detailed procedure is described in the following:

- ① Press the VIEW A key. Place memory B into VIEW B or BLANK B mode.
- ② Press    keys. This will present an active marker at the bottom left corner of the screen.
- ③ Operation of  or  key will enter the upper or lower limit data write mode.
- ④ If  key is pressed, rotation of the DATA knob moves the marker in the vertical direction: clockwise operation of the knob moves the marker upward, and counterclockwise operation of the knob moves it downward.





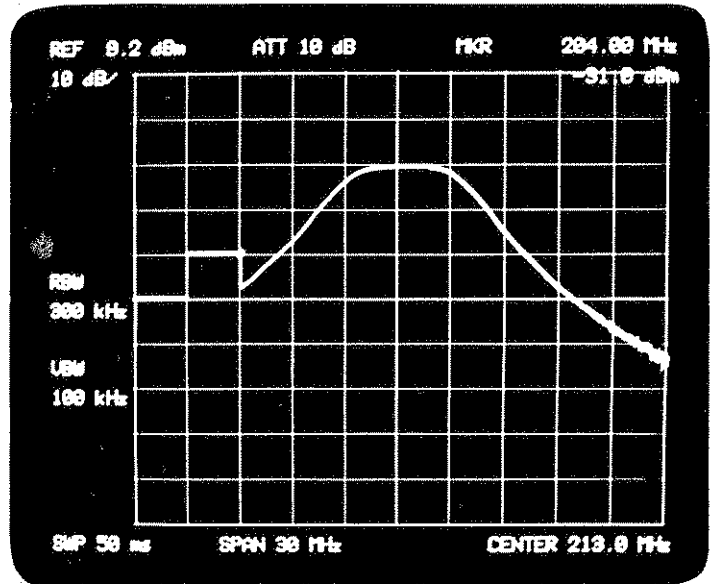
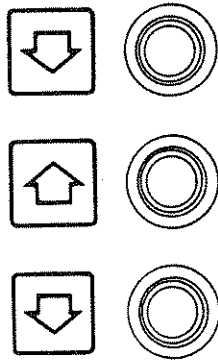



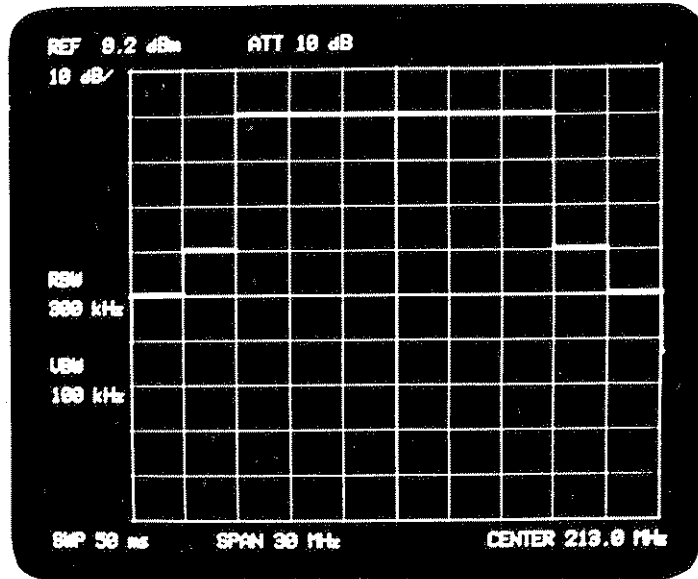



- ⑤ If  key is pressed, operation of the DATA knob moves the marker in the horizontal direction to enable upper or lower limit data writing. Subsequently use  or  key to write the desired upper (or lower) limit data on the screen.



- ⑥ While upper or lower limit data is being written, the frequency and level at the marker are read out at the top right corner of the screen.
- ⑦ If the DATA knob is operated after key is pressed, limit data writing will not occur, and the marker simply moves along the upper or lower limit trace already written on the screen.
BACK SPACE
- Operation of or key will again enter the limit data write mode.
- ⑧ When all upper (or lower) limit data is written, press the SHIFT key. This will erase the marker from the screen and place the analyzer into the normal measurement mode.



⑨ When subsequently writing lower (or upper) limit data as well, proceed with following steps ⑩ and ⑪. If not, proceed with step ⑫.

⑩ When writing lower (or upper) limit data following upper (or lower) limit data writing, press  and  keys, then press  and  keys, then press  and  keys, then press  and  keys, then press  and  keys to present and active marker. Then follow the procedure given in above steps ③ through ⑦ to write lower (or upper) limit data directly on the screen.

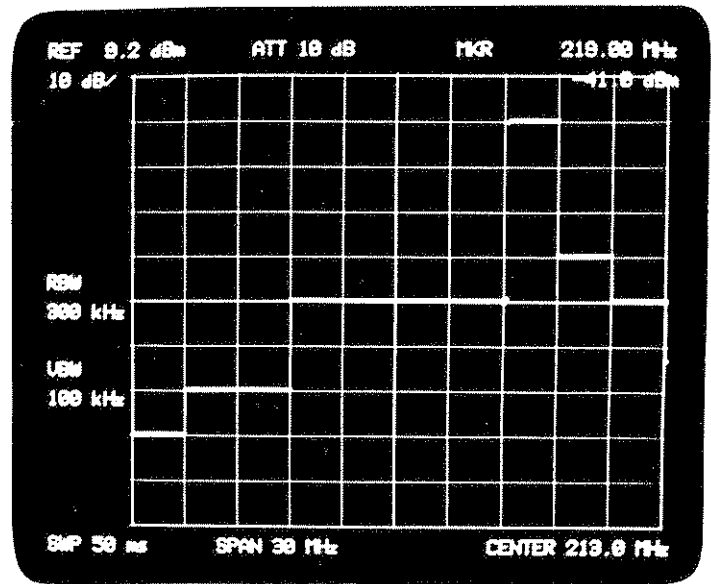
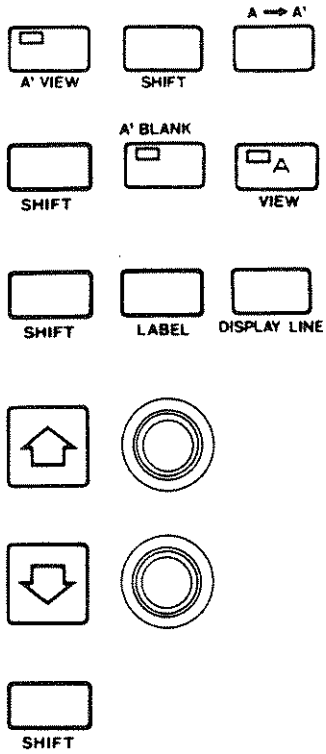

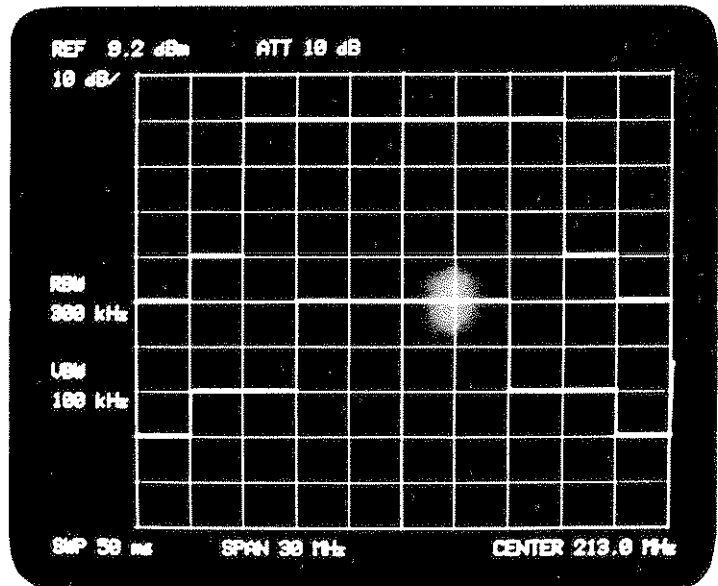

- ⑪ When all lower (or upper) limit data is written into memory A, press the SHIFT key to erase the marker from the screen, then press the VIEW A' key. This will show the lower and upper limit traces each stored in memories A and A', on the display.



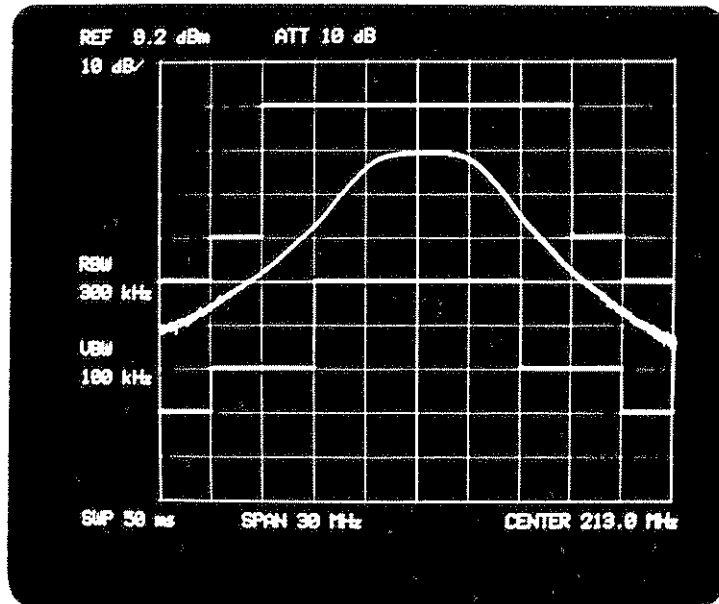

- ⑫ Press the WRITE B key and observe the signal response of the DUT.





- ⑬ Operation of the WRITE A key erases the lower (or upper) limit data from memory A. Operation of   keys erases the upper (or lower) limit data from display, but memory content remains. Therefore, operation of VIEW A' key displays the upper (or lower) limit again.

4-18. SWEEP RESET

Operation of    keys resets sweep to cause it to restart from the leftmost graticule.

4-19. RES. BW 7 Hz

Operation of    keys sets resolution bandwidth (RES. BW) to 7 Hz. In this case, however, data will not be guaranteed as the bandwidth accuracy is outside the specification.

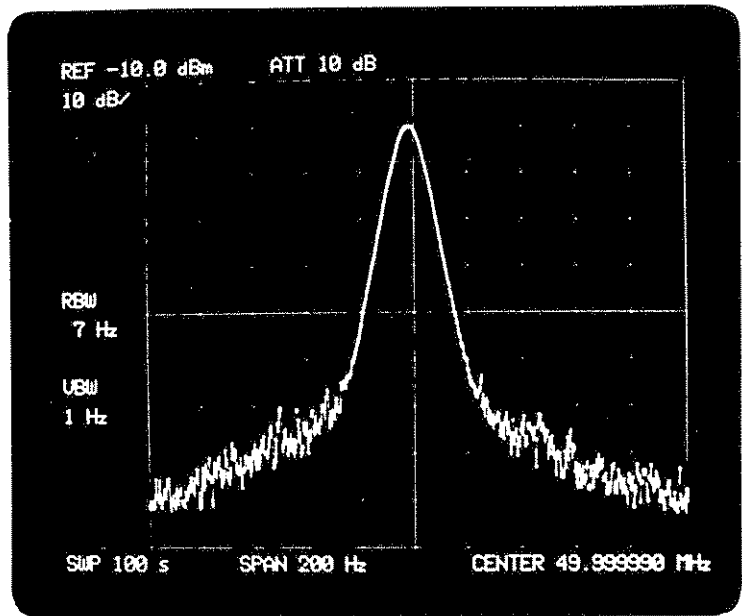

4-20. CENTER FREQUENCY REPOSITIONING (DRIFT CANCEL)

- ① On the TR4172, center frequency is repositioned for each sweep when the following center frequency and frequency span are selected, so as to prevent frequency drift:
 Center frequency: 1500 MHz or below and
 Frequency span: 10 MHz to 510 kHz, or 10 kHz or below
- ② To clear the center frequency repositioning mode for faster screen rewriting, press keys. Center frequency repositioning will subsequently not occur (Drift cancel OFF). The center frequency repositioning mode will be restored by operating keys or key. (Drift cancel ON)
- ③ If the center frequency repositioning mode is desired for a center frequency and frequency span other than those given above, operate keys. The center frequency will be repositioned for each sweep. If, at this time, the CENT. FREQ., FREQ. SPAN, or MASTER RESET key is pressed, the analyzer returns into the original center-frequency repositioning mode, in which center frequency repositioning occurs only for the center frequency and frequency span ranges specified in above item ①.

4-21. OCCUPIED BANDWIDTH DISPLAY

Occupied bandwidth display performs necessary operations to determine the occupied bandwidth from the displayed data on the TR4172. The operations are performed as follows:

There are 1001 points of data on the frequency axis of the TR4172's display. If the voltage of one of the points is assumed to be V_n , the total power P of the signal response on the display is determined by:

$$P = \sum_{n=1}^{1001} \frac{V_n^2}{R} \quad (R: \text{TR4172's input impedance})$$

If the sum of the power between the first (leftmost) and X 'th points on the frequency axis is 0.5% of P , then we obtain:

$$0.005P = \sum_{n=1}^X \frac{V_n^2}{R}$$

If the sum of the power between the first (leftmost) and Y 'th points on the frequency axis is 99.5% of P , we obtain:

$$0.995P = \sum_{n=1}^Y \frac{V_n^2}{R}$$

We determine X and Y from the above three equations, then determine the occupied bandwidth (OBW) from the following equation along with frequency span f_{SPAN} :

$$\text{OBW} = \frac{f_{\text{SPAN}} (Y - X)}{1001}$$

The OBW display procedure is described below.

- ① Select the WRITE A mode and display the desired signal response trace in the center of the screen. Set the vertical scale to 10 dB/div. and leave all marker inactive.
- ② Press the VIEW A key to hold the display, then press



. The occupied bandwidth operation will be initiated. Upon the end of the operation, two markers will appear at points X and Y mentioned above to indicate the calculated occupied bandwidth.

- ③ Operation of the MARKER key will display the occupied bandwidth readout at the top left corner of the screen together with indicator "OBW". The marker frequency readout at the top right corner of the display shows the frequency at the right-hand side marker.
- ④ To obtain the relative value readout of the total spectrum power, P (1×10^3 to 1.7×10^{13}), in the top display area of the screen, press the SHIFT key.
- ⑤ If the MKR OFF key is pressed, the display and readouts pertaining to occupied bandwidth disappear from the display and the TR4172 returns to the normal measurement mode.

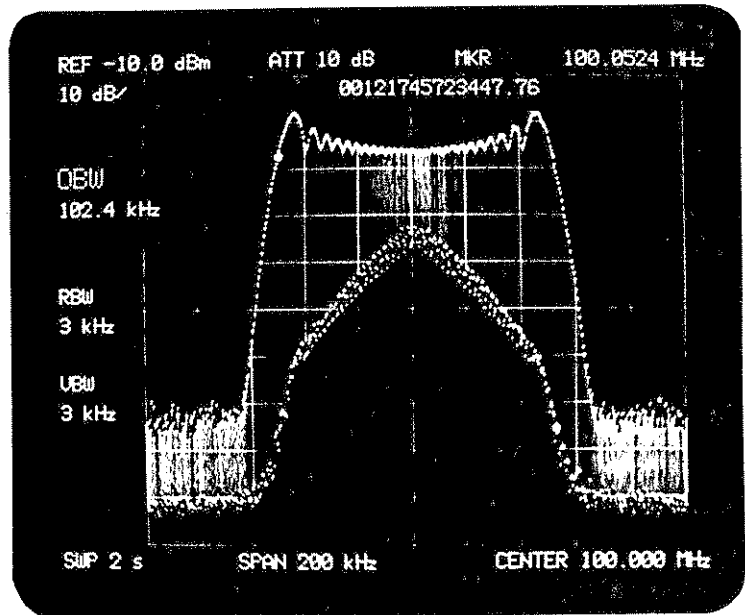
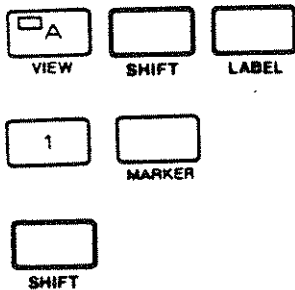



- ⑥ Occupied bandwidth data can be obtained with less error by setting resolution bandwidth to 1/200 of the frequency span or less. And maximum value or average value of the occupied bandwidth can also be measured by using MAX. or AVG. mode concurrently.



4-22. HELP MODE

No specific panel inscription or indicator is provided for the double shift function for which a specific key is pressed after  and

 keys are operated.

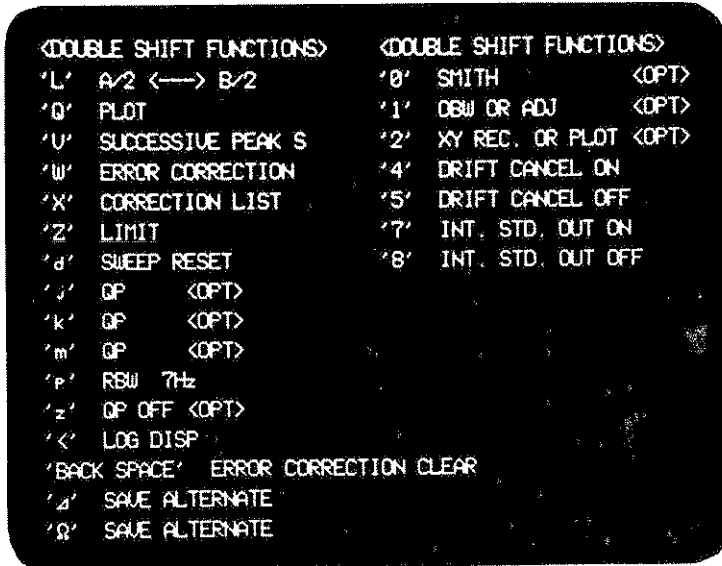
Operation of   selects the HELP mode, in which the display provides a listing of the above double shift key functions on the screen. Note that when the instrument is set up in the state in which only the specific key operation can be entered in the mode such as ALTERNATE SWEEP or LOG. DISPLAY, the HELP mode cannot be activated. Reset the mode to the normal measurement mode to activate the HELP mode.



Pressing  or  key clears the list and the analyzer returns to the normal condition.

Appendix A-1 lists the pages containing descriptions of each double shift function.

4-23. MEASURING ADJACENT NOISE LEVEL OF OSCILLATION BY AVERAGING

This paragraph describes how to measure the adjacent noise level for 50 MHz oscillation by using the averaging feature (Section 4-14-1). The adjacent noise analysis range is assumed to be ± 50 kHz of the oscillation frequency.

- 1) Connect the output of a 50 MHz oscillator to INPUT-1 on the TR4172 as shown in Figure 4-2.

TR4172

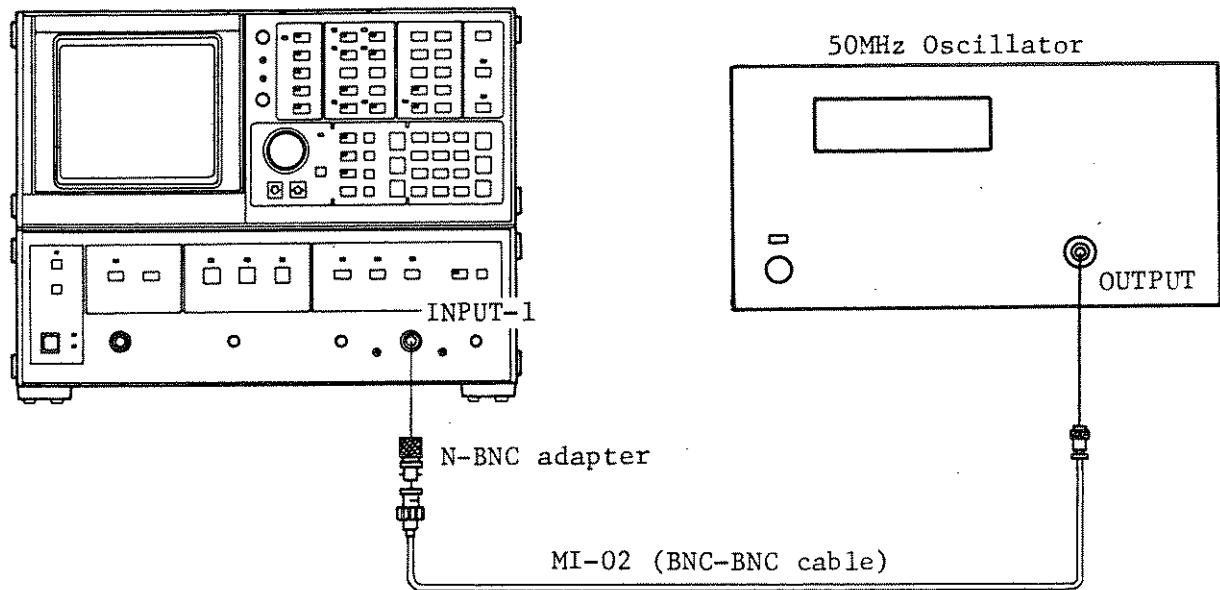





Fig. 4-2 Measurement setup

NOTE

- 1) When the oscillator output is directly coupled to the TR4172 input, the output frequency may be subject to change due to the input capacitance of the TR4172. If this occurs, use a probe with a smaller cable capacitance for the input connection.
- 2) The maximum allowable input level to the TR4172 is +20 dBm when the input attenuator is set at 20 dB or greater.
Be careful not to apply an input level exceeding +20 dBm. Use an external attenuator if necessary.

② While the TR4172 is in the initial default state (immediately after MASTER RESET key operation), prepare it as follows:

- (a) Set the center frequency to 50 MHz.
- (b) Set the center frequency span to 100 kHz to accommodate the analysis range of +50 kHz.
- (c) Set the reference level. For example, if the input signal level is -20 dBm, set the reference level to -20 dBm.
- (d) The sweep span, resolution bandwidth, video bandwidth, and so forth are automatically set to the optimum values according to the selected frequency span, since the AUTO mode is in the initial default selection. If, for example, desire manual selection for those parameters, press    to set resolution bandwidth to 1 kHz. Once the manual mode is selected for a parameter, the lamp in the relevant parameter key comes, on. In this case, the resolution bandwidth is fixed to 1 kHz. Note that the resolution bandwidth remains at 1 kHz if the frequency span is subsequently changed.

CENT. FREQ. 5 0 MHz dB sec

FREQ. SPAN 1 0 0

kHz +dBm msec

REF. LEVEL 2 0 Hz -dBm usec

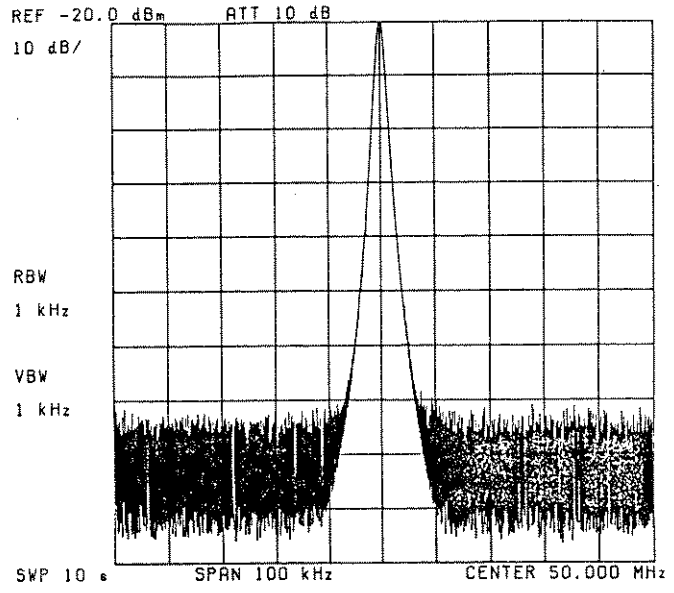

③ Repeat averaging 32 times

AVG. ON

SHIFT

Hz -dBm usec

3 2

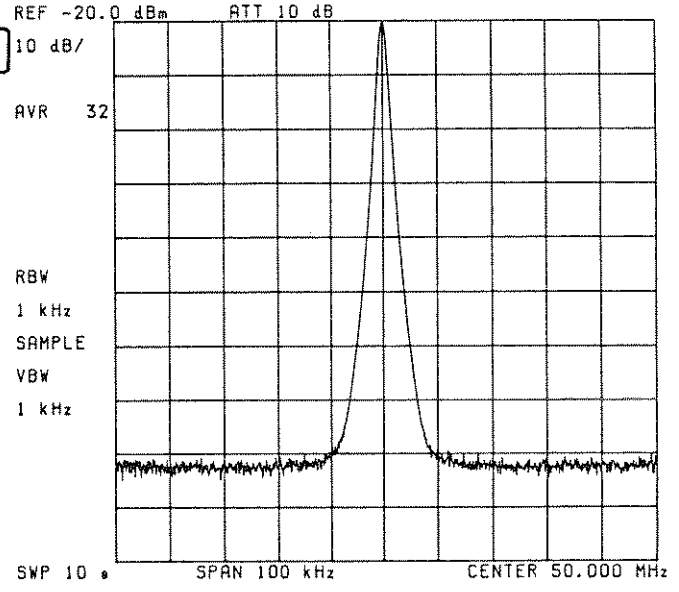

- ④ Activate a marker and measure the adjacent noise level (for example 20 kHz apart from the signal response).

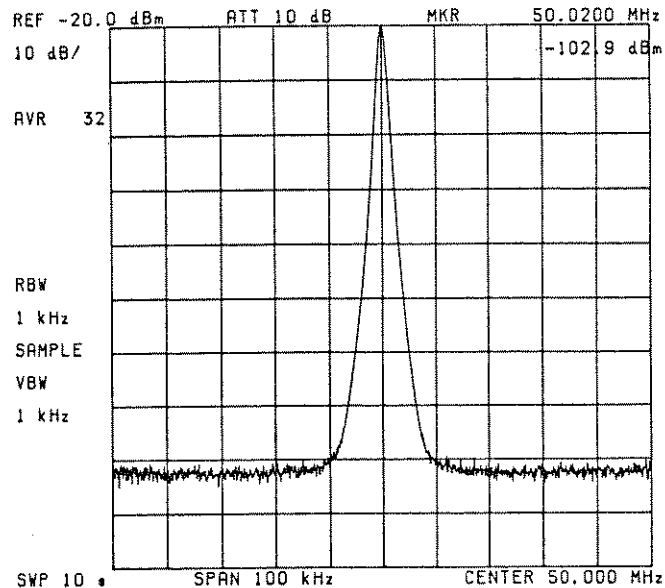
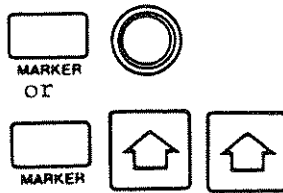

The marker will move one horizontal division on the scale each time the stop key is pressed. In this example, operating the step key twice.



captures the maximum peak of the displayed signal response trace.



positions the reference level at the level identified by the marker (disabled during averaging).

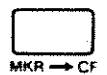

specifies the frequency identified by the marker as the center frequency (disabled during averaging.)



NEG. PEAK S.



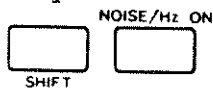

captures the minimum level of the displayed signal response trace.

- ⑤ If you wish to measure adjacent noise level (noise/Hz), press



. This provides for bandwidth conversion for an ideal filter and level compensation for the logarithmic amplifier by the internal CPU, thereby permitting precise measurement.

To return to the normal measurement mode, press  .

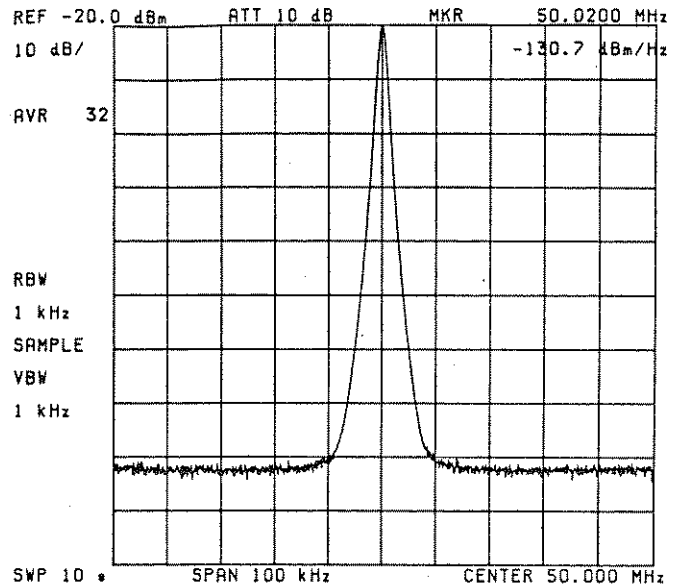
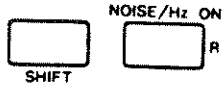

4-24. EVALUATION FOR TR4172'S DYNAMIC RANGE BY TWO-SIGNAL RESPONSE

This paragraph shows an evaluation example for the TR4172's dynamic range based on its two-signal response (intermodulation distortion characteristic between the fundamental signal and the 3rd harmonic).

- ① Connect the outputs of two signal generators to the input of the TR4172 via a two-signal measuring pad (two-signal branching unit) (See Figure 4-3). When setting the SG output level, the insertion loss (approximately 6 dB) of the branching unit should be taken into account. If you set the outputs of the two SGs at the same frequency, note the maximum allowable input level of the TR4172 (+20 dBm).

It will help if you have prior information about the signal-to-noise and carrier-to-noise ratios of the two signal generators used.

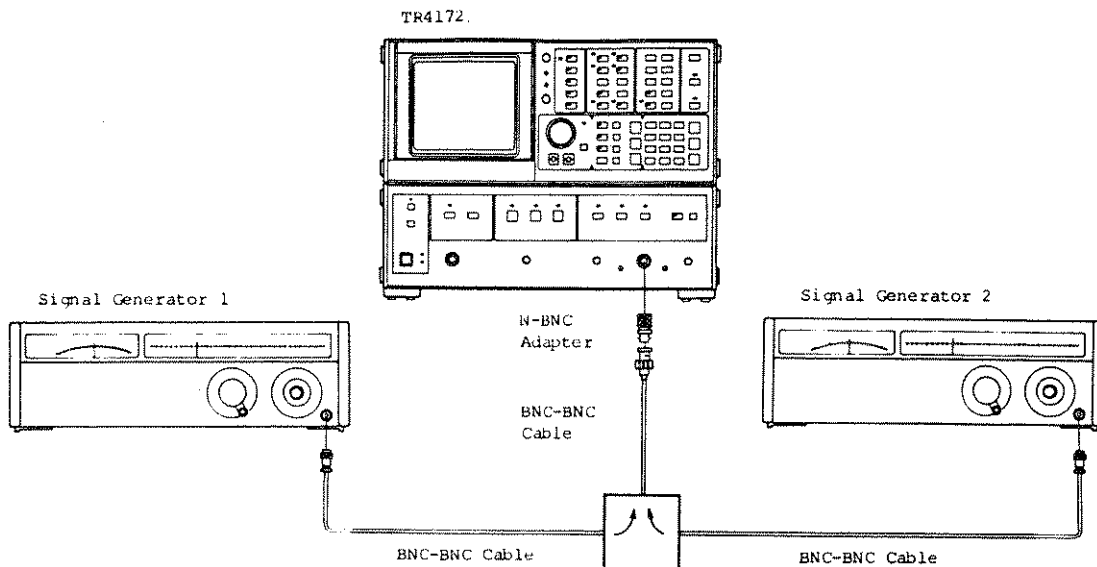

Fig. 4-3 Measurement setup

- ② Set up signal generator output frequencies. In this example, signal generators A and B are set up respectively for 91 MHz and 92 MHz.
- ③ With the TR4172 in the initial default state, prepare it as follows:
Center frequency: 91.5 MHz (middle of the two SG output frequencies)
Frequency span: 5 MHz
Reference level: 0 dBm
- ④ If the noise level is too high, manually narrow resolution bandwidth (initially set at the AUTO mode). Note, however, that a resolution bandwidth set too narrow will make the sweep time too long.
- ⑤ Execute averaging if needed. When executing averaging, select a number of averaging repetitions (such as 8 or 16) fewer than the initial averaging number setup of 128 because this number will make analysis time too long.

SHIFT AVG. ON (Initiates 8 repetitions of averaging sequence.)

- ⑥ The TR4172 has a display dynamic range of 95 dB. Adjust the reference level (while reducing the SG output levels) to search for the maximum sensitivity. If necessary, adjust the input attenuator as well.

CENT. FREQ.	9	1
.	5	MHz dB sec
FREQ. SPAN	5	MHz dB sec
REF. LEVEL	0	kHz +dBm msec

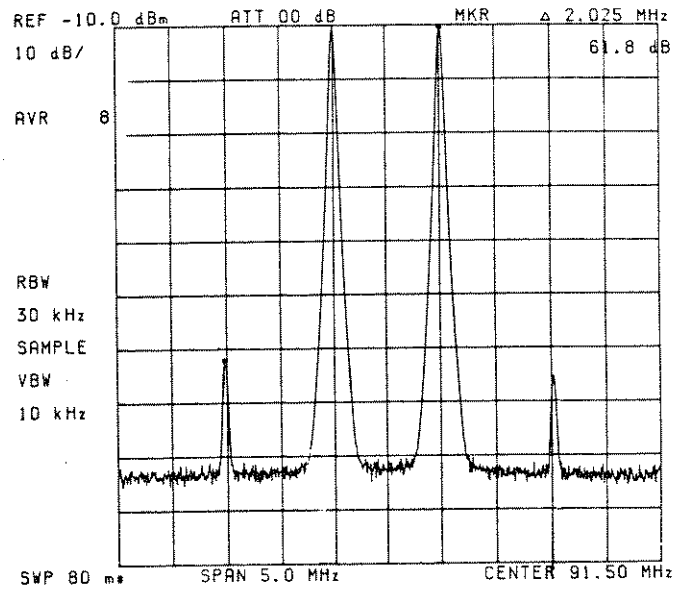

- ⑦ Read the difference between the input level and distortion level with the delta marker (see Figure 4-4). The two-signal characteristic represents the intermodulation distortion between the fundamental wave and the 3rd harmonic. It implies the anti-saturation characteristics of the mixers or amplifiers used in the spectrum analyzer.

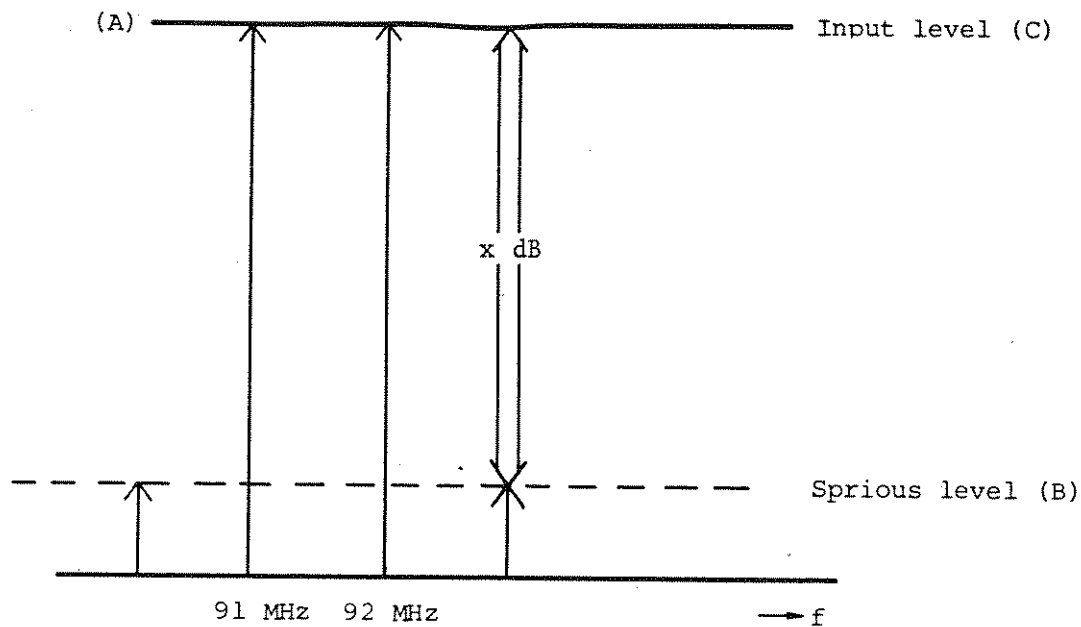

Fig. 4-4 Two-signal characteristic measurement

The intersection of the fundamental wave and the 3rd harmonic distortion is called the intercept point. It is expressed by an absolute value of the input such as XX dBm.

To determine the intercept point from the measured data, use the following formula:

$$\frac{A - B}{2} + C$$

A = Two-signal input level (dBm)
 B = Spurious level (dBm)
 C = Input level (dBm)

In the above example, the intercept point of the TR4172 is +20 dBm.

4-25. SIMULTANEOUS MEASUREMENT OF THE 2ND AND 3RD HARMONICS OF A RADIO TRANSMITTER

This paragraph describes simultaneous measuring procedure for the fundamental, 2nd harmonic, and 3rd harmonic outputs of a 144 MHz radio transmitter.

- ① Apply the output of the transmitter to the input of the TR4172 Spectrum Analyzer via the TR1625 RF Coupler (see Figure 4-5). The TR1625 RF Coupler has an attenuation level of 40 ± 1 dB over a frequency range between 0 MHz and 1000 MHz. If the output power of the transmitter is 10 W, it is attenuated to $100 \text{ W}/50 \Omega$ (-10 dBm) when applied to the input of the TR4172.

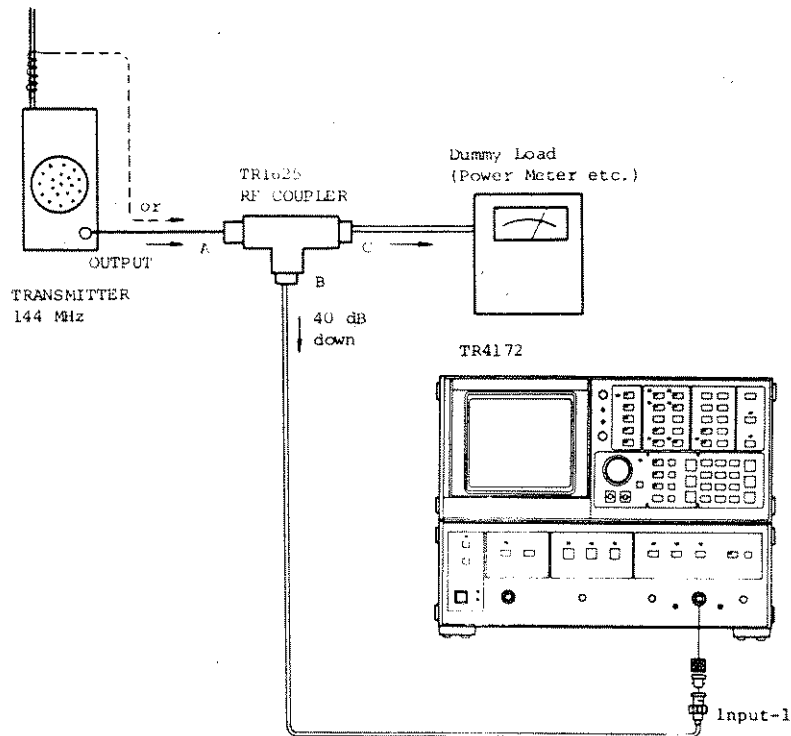
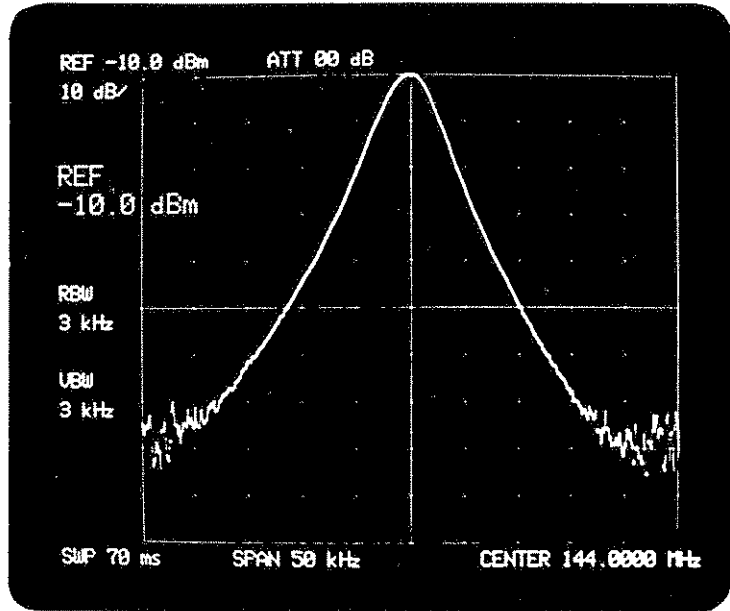





Fig. 4-5 Measurement setup

- ② When the analyzer is in its initial default state, set the center frequency to 144 MHz, frequency span to 50 kHz, and reference level to -10 dBm.

CENT. FREQ.	1	4
4	MHz dB sec	
FREQ. SPAN	5	0
	kHz +dBm msec	
REF. LEVEL	1	0
	Hz -dBm µsec	



- ③ Since the WRITE A mode is the initial default selection, the fundamental response trace is stored in trace memory A. Transfer this trace information into memory A' by pressing    .
- ④ Next, double the center frequency setting to observe the 2nd harmonic in the transmitter output. If the center frequency step size is set to 144 MHz, the center frequency will be multiplied in an integral sequence (double, triple and so on) each time the STEP UP key is pressed. Use trace memories A, A', and B to superimpose higher harmonics on the fundamental response trace.

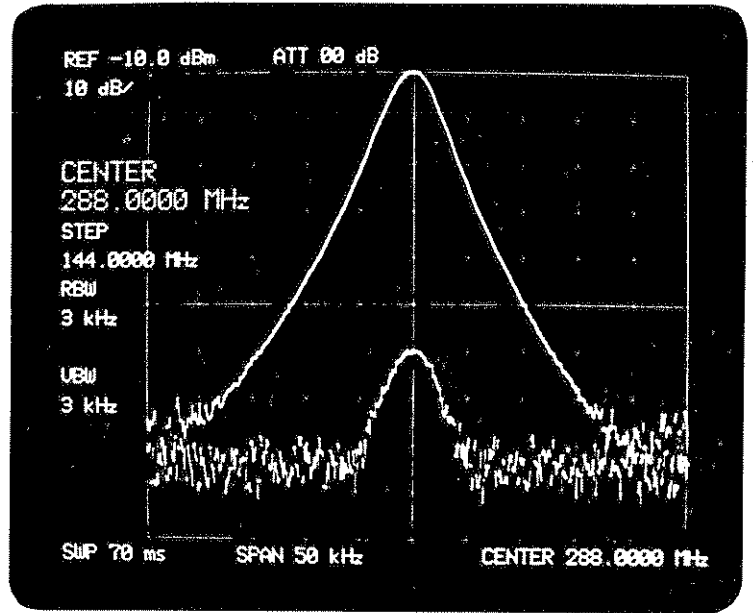
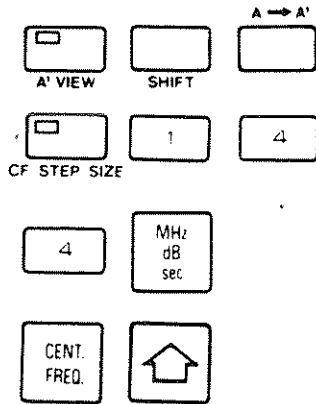

- ⑤ Press the WRITE B key. Memory A will be automatically placed in the VIEW (still) mode. Observe the 3rd harmonic response on active display B.

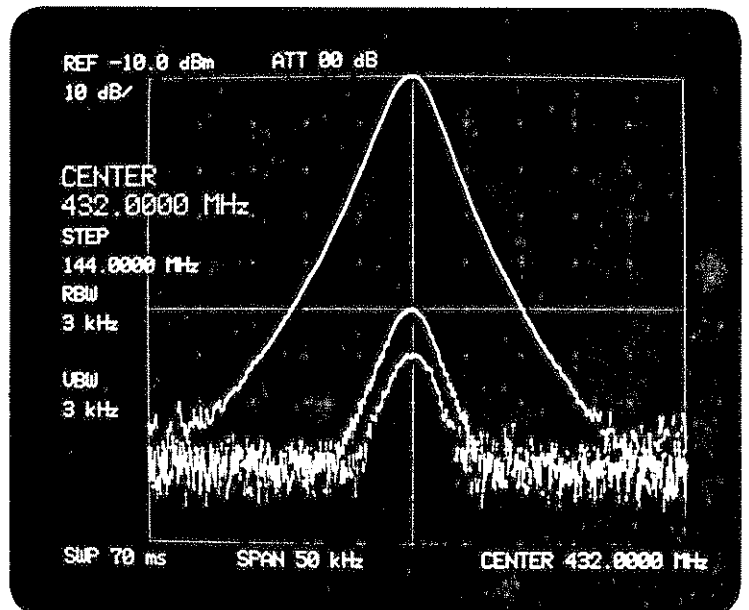

- ⑥ The completion of these procedures will display the three screens, A', A, and B, concurrently. When four screens are needed, press the B → B' switch to store the harmonics of the third order in memory B' and the next waveform information in active screen B.
- ⑦ Press ^{A' BLANK}
_{SHIFT} to clear the screen of the fundamental wave stored in memory A'. Other memories can be cleared in a similar way.

4-26. INTERNAL STANDARD OUTPUT ON/OFF

When the _{SHIFT}, _{LABEL}, and 7 keys are pressed sequentially, the 10 MHz standard oscillator output is output from the INT. STD OUTPUT (J4) connector at the TTL level.

Measure this output with a more precise counter or frequency standard and comparator, then adjust it with the STD ADJ. control to accurately set the output to 10 MHz.

Pressing the _{SHIFT}, _{LABEL}, and 8 keys sequentially will cut off the internal reference oscillator output. This output is cut off when this instrument is initialized by power on operation or by pressing the MASTER RESET key.

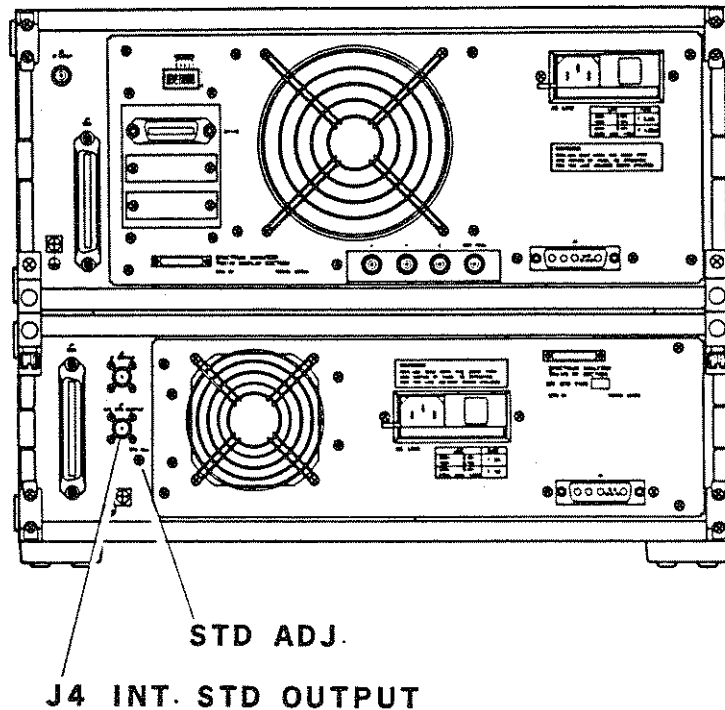

4-27. ADJACENT CHANNEL LEAKAGE POWER ARITHMETIC OPERATION SOFTWARE (OPTION 06)

The data on trace A measured by TR4172 is divided into 1001 points on the frequency axis, the power equivalent to the width specified by the delta marker is integrated, and the ratio of the integration result to the total power is displayed on trace B.

When P_n is the power between each points on screen A, total power P is obtained from:

$$P = \sum_{n=1}^{1001} P_n$$

When ΔX is the width of a delta marker, data P_{ADJ} on screen B after arithmetic operation is obtained from:

$$P_{ADJ} = 10 \log \frac{\sum_{n-\Delta X/2}^{n+\Delta X/2} P_n}{P}$$

Two methods for integration by the ΔX width can be selected: ideal filter (ΔX width) and trapezoidal filter (ratio of 90 dB/6 dB is set in the range of 1.0-9.99).

The adjacent channel leakage power arithmetic operation procedure is as follows:

- ① Measure the waveform on trace A.
- ② Press the VIEW A key to freeze the trace. Specify the integration width by the delta marker.
- ③ Operate , , and keys.
SHIFT LABEL
- ④ Press the key for integration by an ideal filter. Press the key for data only. The ratio (dB) of the adjacent channel leakage power to the total power at the first marker is displayed under ADJ. The frequency at this point is displayed on the upper right of the CRT screen.
- ⑤ Press the key for waveform integration by a trapezoidal filter. To obtain the dB value, press the key, then select

the ratio of 90dB to 6 dB.

When the key is pressed, the ratio is 2.24.

When the key is pressed, the ratio is 1.75.

When the key is pressed, the ratio is 1.66.

When the key is pressed, any ratio may be set in the range of 1.0-9.99.

In this case, input the value of $100 \times [90 \text{ dB}/6 \text{ dB}]$ by the DATA keyboard, then press the key.

The operation time is prolonged as the delta marker width increases. Sometimes, it takes more than one minute.

⑥ When the key is pressed, or , , keys are operated, the ordinary measurement mode is selected.

⑦ If the and keys are pressed after pressing the key, the marker is moved to the integration waveform on trace B. Thus, the ratio (dB) to the total power at any marker point can be

read. In this case, press the and keys, input the offset value, and then set the reference level to 0 dB, because the integration waveform is drawn with reference to the total power. Accordingly, if the reference level is set to 0 dB including the offset, the value at the marker can be read out directly. When an integration waveform is drawn, the waveform on both ends of the display become zero waveforms (approximately 1/2 of the integration width).

⑧ Occupied bandwidth can be measured by operating

, , keys and then pressing the key again.

It also can be measured by pressing the key after the measurement of adjacent leakage power arithmetic operation.

- ⑨ If the key is pressed before selecting the ordinary measurement mode by pressing the ^u key, the integration trace can be plotted directly by TR9831 or TR9834R plotter.

Note) "ADJ" displayed on the CRT means adjacent.

4-28. X-Y PLOTTER INTERFACE (OPTION 07)

This option is a software program allowing connection to the Hewlett Packard Model 9872A/7470A/7225A Plotter. This option must not be used together with option 03; however, combined use with other options is permitted. Read the instruction manual for the purchased plotter before connecting a plotter to the TR4172, switching the plotter power on, or setting the pen. Set the 9872A address to "5", and other plotters' addresses to "listen only".

Note: Set the TRACE MODE to VIEW, before plotting the averaged waveforms in HP output format.

The X-Y plotter interface operating procedure is as follows:

- ① Display the waveform (Smith chart) to be plotted on the TR4172 CRT screen.

- ② Operate the _{SHIFT}, _{LABEL}, and 2 keys to load the program.

- ③ The following is displayed on the CRT:

```
9872A : '1'           7470A : '2'  
7225A : '3'           QUIT  : '4'
```

Press one of the 1, 2, or 3 key according to the type of the connected plotter.

If the 4 key is pressed, the state before program loading is restored.

If the message above is not displayed instantly,

```
"<ERROR> PLOTTER DOWN OR ADDRESS SW. IS NOT "5" OR CONNECTER  
DRAWN OUT RERUN OR QUIT <1 OR 0>"
```

is displayed approximately 5 seconds later. If this message is displayed, check if the plotter is powered on, plotter's address switch is set to "5" or "listen only", and connector is properly connected.

To execute the plotter program again, press the key.

If the key is pressed, the state before program loading is restored.

- ④ Then, the following is displayed on the CRT:

ALL : '1' DATA : '2'
QUIT : '3'

To plot all data on the CRT screen, press the key. To display only the waveform, press the key.

If the key is pressed, the state before program loading is restored.

In the Smith chart list mode, plotting starts without displaying the above message.

- ⑤ Then, the characters, which were displayed in the center of the left half of the CRT screen (active area) before program loading, are displayed again and plotting starts.

Table 4-6 Pen numbers

Trace Model	TRACE "A"		TRACE "B"	
	A	A'	B	B'
9872A	2	4	3	1
7470A	1	1	2	2

- ⑥ If the key is pressed while the plotter is running, plotting is forcibly stopped and plotter selection menu is displayed on the CRT. Change the plotting paper and follow the operation procedures from item ③ again.

CAUTION

To plot an averaging waveform, it is necessary to set TRACE function to the VIEW mode before commencing an actual plotting. (See Section 4-10.)

4-29. N dB DOWN WIDTH MEASUREMENT

4-29-1. Specification

Displays two markers at the level N dB below the preset marker on the waveform; and displays a frequency differences between the two markers or their frequency differences with respect to the center frequency, and the frequency and amplitude level of the left marker.

4-29-2. Operating Procedures

Note: This mode can be used when the vertical scale is in the logarithmic scale of 10 dB/div to 1 dB/div.

- ① Set the waveform in the VIEW mode to freeze it. Display a regular marker and move it to the desired peak.

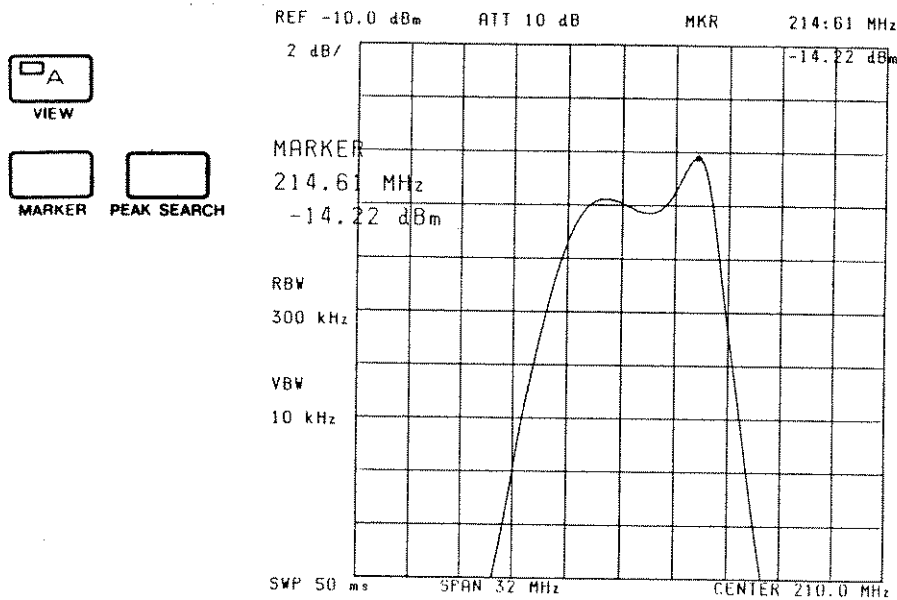

- ② Press the , , and keys in this order. This option program is loaded and this mode becomes active. "dB DOWN" is displayed in the active function area at the middle left of the CRT.

If this key operation is performed when the regular marker is not displayed or when the delta marker is displayed, the analyzer enters the NEXT PEAK mode.

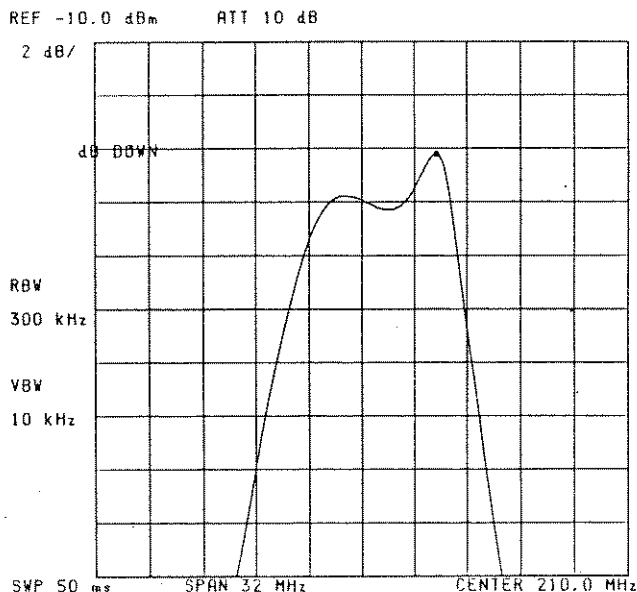
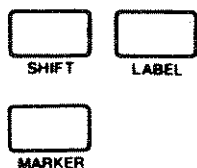

- ③ Enter a down level from the peak using the DATA keyboard. Acceptable data is from 0.1 dB to 99.9 dB.

(Example)

..... 10.5 dB

- ④ Press the or key. A marker is displayed at the right and left side points on the waveform N dB (input value) below the preset marker.
- A frequency differences between the right and left markers is displayed in the active function area at the middle left of the CRT when the key is pressed,

MHz
dB
sec

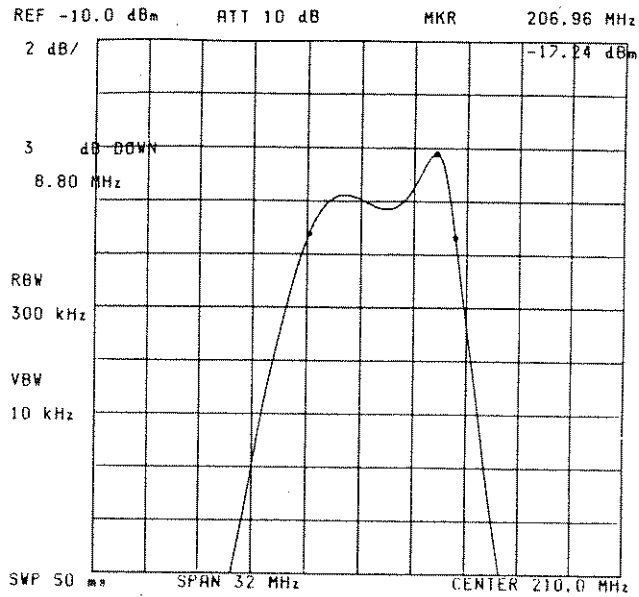

and a frequency differences of the left marker (headed by "L") and right marker (headed by "R") with respect to the center frequency when the

kHz
+dBm
msec

 key is pressed.

kHz
+dBm
msec

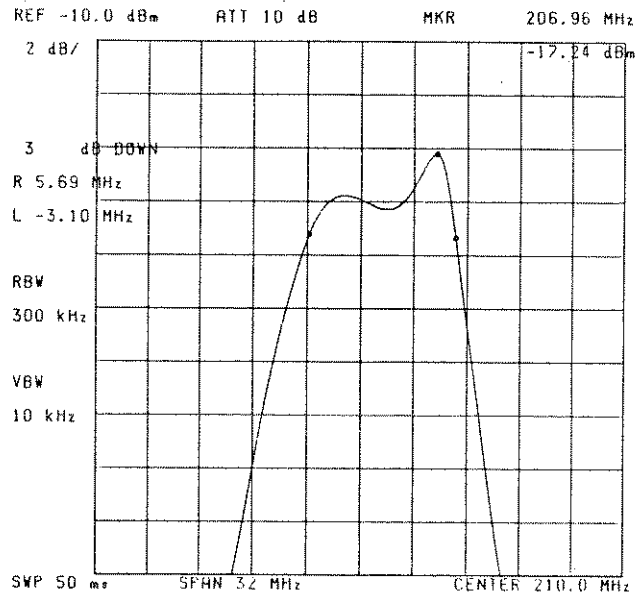

In both cases, the frequency and amplitude level of the left marker are displayed in the marker area at the upper right corner of the CRT.

"ERROR" is displayed in the active function area when an entered value is beyond the required size (0.1 dB to 99.9 dB) or when the waveform does not exist at the level N dB below the preset marker. In such a case, repeat the operation from step ③ again.

- ⑤ Operation from step ③ can be repeated.
- ⑥ The following three ways are available to exit from this mode:
- Press the key. Execution exits from this mode with the marker off.
MKR OFF
 - Press the key. Execution exits from this mode with the central marker changed to the normal marker.
MARKER
 - Press the key. Execution exits from this mode with the right and left markers changed to the delta markers.
Δ

When a function key other than the above is pressed, execution exits from this mode. In this case, however, the marker is not cleared. So, press the key to clear the marker after setting this mode again.
MKR OFF

To set N dB DOWN WIDTH mode after exiting from this mode, start from the beginning.

4-29-3. Operation by GPIB

The remote operation by GPIB is performed accordingly, by programming codes corresponding to the panel keys operated in the manual operation in the same order.

4-30. NEXT PEAK SEARCH FUNCTION

4-30-1. Specification

Displays positive peaks in descending size order, negative peaks in ascending size order, or positive and negative peaks in left-to-right order in the section specified on the waveform by the delta marker.

4-30-2. Operating Procedures

- ① Set the waveform in the VIEW mode.
- ② Specify the section to be measured by the delta markers.
- ③ Press the SHIFT, LABEL, and MARKER P keys in this order. This option program is loaded and this mode becomes active.

The following messages are displayed in the active function area at the middle left of the CRT:

POS. NEXT: 'R'

NEG. NEXT: 'S'

LEFT NEXT: 'T'

If this step is performed with no marker displayed, a marker is displayed at the right and left ends of the trace. Then, these two markers become the delta markers.

If this step is performed with the regular marker displayed, the analyzer enters the N dB DOWN WIDTH mode.

- ④ When the R key is pressed, a marker is displayed in the position of the maximum positive peak in the section specified by the delta markers, and its frequency and amplitude level are displayed.

Then, every time the V key is pressed, a positive peak in the section specified by the delta markers is displayed in descending size order. The place of a displayed peak in a series is displayed in the active function area.

When the S key is pressed, a marker is displayed in the position of the minimum negative peak in the section specified by the delta markers, and its frequency and amplitude level are displayed.

Then, every time the V key is pressed, a negative peak is displayed in the section specified by the delta markers in ascending size order. The place of a displayed peak in a series is displayed in the active function area.

When the T key is pressed, a marker is displayed in the position of the leftmost peak in the section specified by the delta markers, and its frequency and amplitude level are displayed.

Then, every time the V key is pressed, peaks in the section specified by the delta markers, both negative and positive, are displayed in left-to-right order. The place of a displayed peak in a series of positive or negative peaks---"+N" or "-N"---is displayed in the active function area.

- ⑤ To exit from this mode, follow the procedure outlined in step ⑥ of Section 4-29 "N dB DOWN WIDTH MEASUREMENT".
- ⑥ To obtain, for example, the maximum positive value by using this program, point a where the slope of the waveform exceeds $\Delta Y/\Delta X$ is obtained. Next, point d of a slope of $-\Delta Y/\Delta X$ is obtained. Then, the maximum value between these two points is obtained.

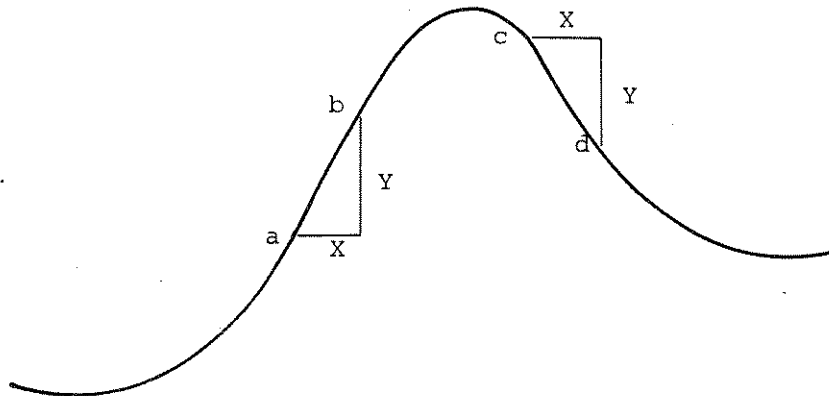

The initial values of ΔX and ΔY are 20 and 5 points respectively for a CRT resolution of 1001 x 1001 points. By changing ΔX and ΔY , the sensitivity of peak detection can be changed.

For instance, the entry " X 3 0 Hz
-dBm
μsec " from the
DATA keyboard sets ΔX to 30 points. The entry " Y 2
 0 Hz
-dBm
μsec " sets ΔY to 20 points.

The number of points, both ΔX and ΔY, can be set within the 1 to 255 range.

4-30-3. Operation by GPIB

The remote operation by GPIB is performed accordingly, by programming codes corresponding to the panel keys operated in the manual operation in the same order.

4-31. START/STOP FREQUENCY SETTING

In addition to setting the center frequency and frequency span, this device sets start and frequencies by pressing , , . In this mode, the switch is used to set the start frequency and the switch is used to set the stop frequency. The setting resolution of the frequency difference between the start and stop frequencies is the same as the one set in the normal center frequency and frequency span setting modes.

Start and stop frequency can be set in the 0 - 2000 MHz frequency range.

Pressing , , key, here will result in normal center frequency and frequency span mode.

Note that the SIGNAL TRACK and ZOOM switches cannot be used in this mode.

4-32. Gated Sweep Function (Option 12)

Note

When this option is mounted, the X-Y recorder output (option 03) cannot be incorporated.

4-32-1. General

This option allows analysis of the burst signal, which is often used when magnetic tape such as VTR, 8mm video, or DAT (digital audio tape) is recorded.

4-32-2. Measurement method

Executes sweep from the gate in the terminal (BNC connector) on the rear panel of this unit at TTL level "Hi" (or open) and stops sweep at "Lo".

Input signal and gate control signal are used in the following specifications.

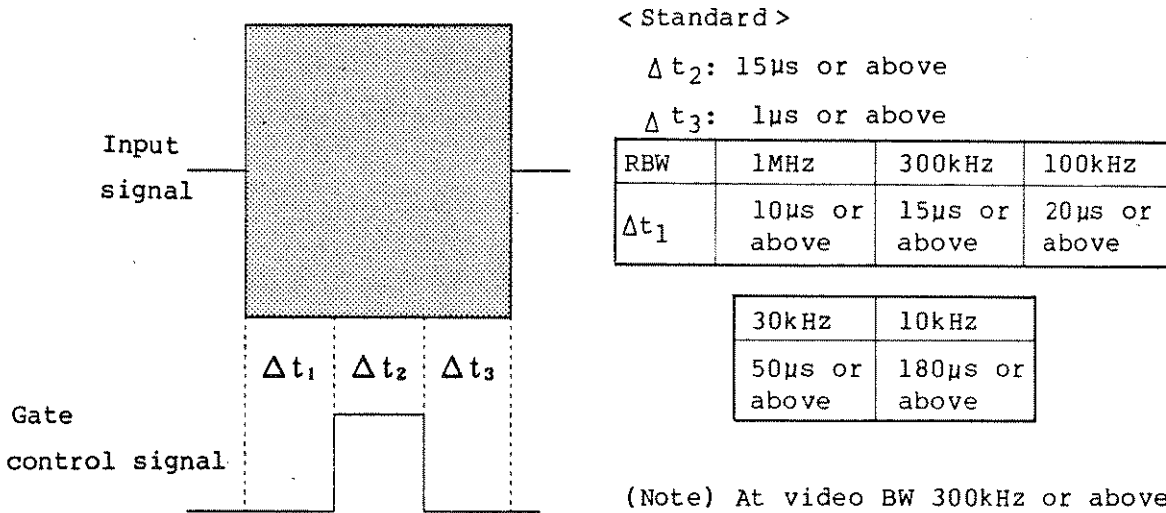

When measuring noise, select the detection mode to SAMPLE



4-32-3. Measurement examples

The data comparison diagram between normal sweep and gated sweep is as follows:

[Normal Sweep]

[Gated Sweep]

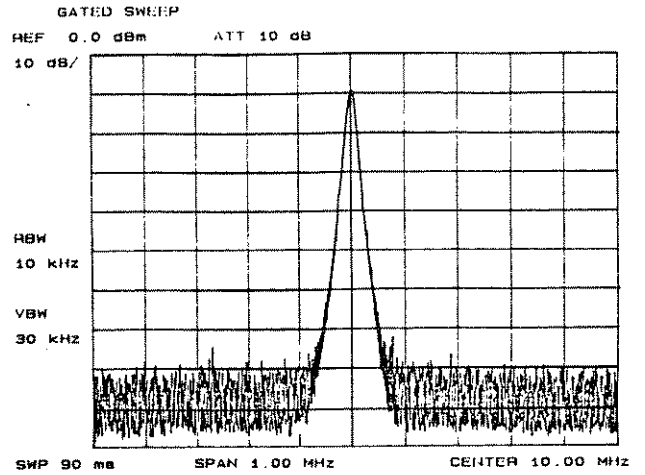
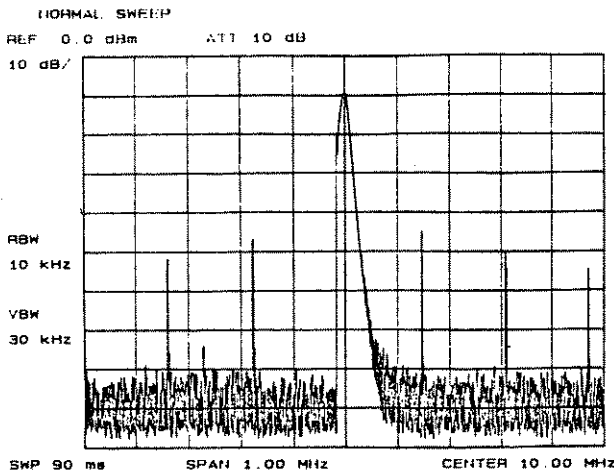

(1) On normal sweep, the pulse component in the burst part is on the data or part of data is lacking.

(2) On gated sweep, the spectrum of the signal in the burst can be analyzed the same as usual.

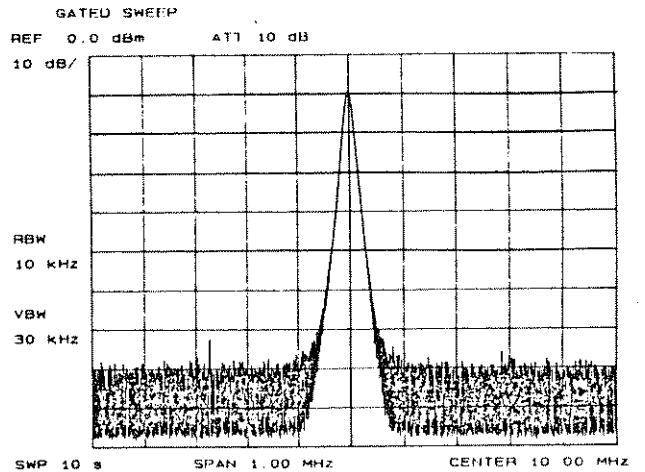
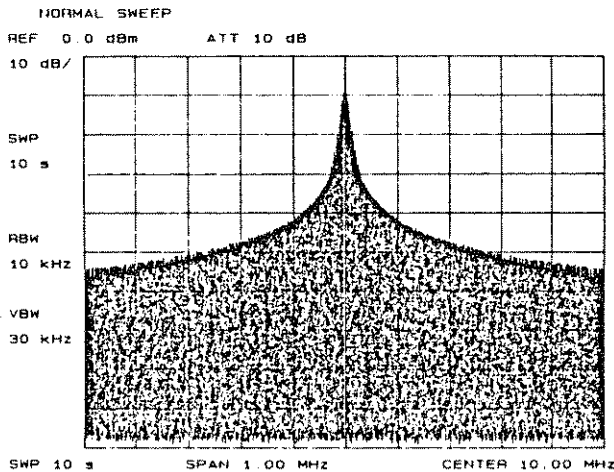

(3) On normal sweep, when sweep time slows down, the pulse component in the burst part appears as an envelope.

(4) On gated sweep, the spectrum of the burst signal part can be analyzed even if the sweep time slows and resolution increases.

Fig. 4-6 Data comparison between normal sweep and gated sweep

(continues to the next page)

[Normal Sweep]

[Gated Sweep]

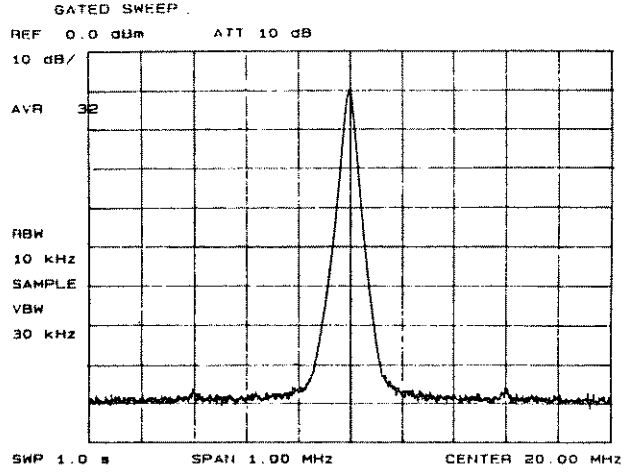
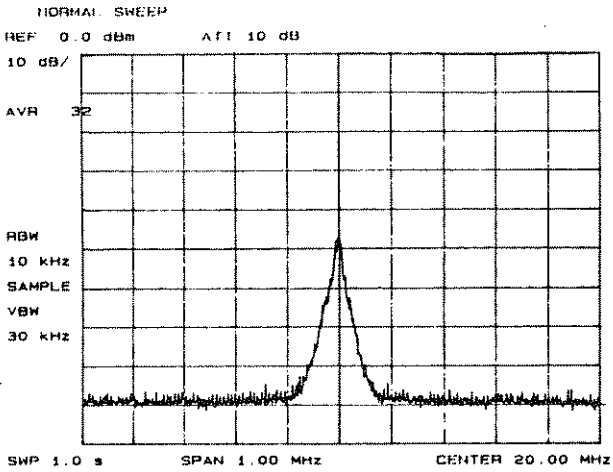

(5) If the averaging is executed when the burst signal is measured, the conventional measurement cannot be made as shown in the above diagram.

(6) On gated sweep, the C/N of burst signal can be measured even if the averaging is executed.

Fig. 4-6 Data comparison between normal sweep and gated sweep (cont'd)

SECTION 5
TRACKING GENERATOR OPERATIONS

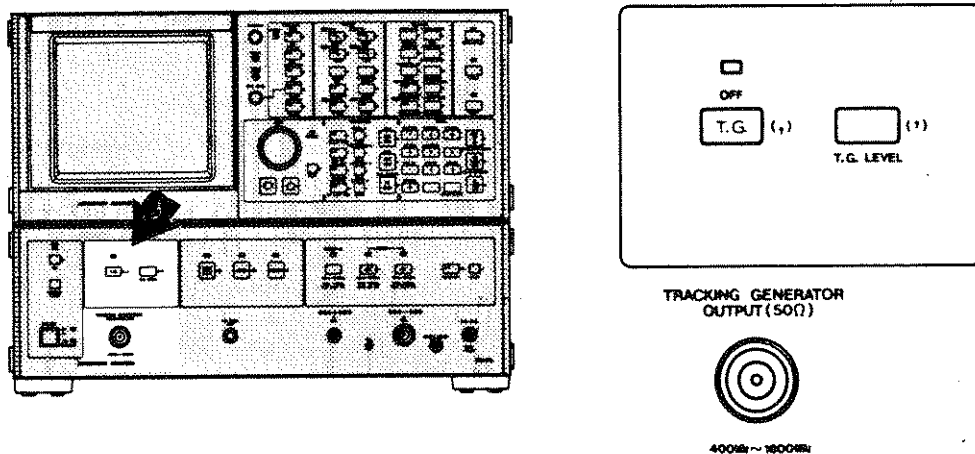

5-1. OPERATING TRACKING GENERATOR

- ① Press the POWER switch to the ON (in) position.
- ② Set up the analyzer for the following conditions:

Center frequency	900 MHz
Frequency span	1800 MHz
Reference level	-10 dBm
Resolution bandwidth	300 kHz
INPUT attenuator	10 dB
- ③ Press the T.G. key to activate the tracking generator; the indicator lamp just above the key lights.
- ④ The T.G. LEVEL key, when pressed, enables output attenuation level for the tracking generator to be controlled in 10 dB steps using the DATA step keys.

Press the T.G. LEVEL key and set the tracking generator's output attenuator to 10 dB using the DATA step keys.
- ⑤ Connect the TRACKING GENERATOR OUTPUT connector to the INPUT connector with a coaxial cable. The CRT display will present a through frequency response.
- ⑥ Disconnect the coaxial cable from the INPUT connector and then reconnect it to the input of the device under test.

Press the T.G. LEVEL key and set the tracking generator's output attenuator to an appropriate level between 0 dB and 50 dB. The output impedance of the tracking generator is approximately 50 Ω.

- ⑦ Connect the output of the device under test to the INPUT connector of the analyzer using another coaxial cable. The input impedance of the analyzer is approximately 50 Ω .
- ⑧ The noise level can be lowered and hence a broader dynamic range can be obtained by narrowing the IF bandwidth using the RES. BW key. Note, however, that a resolution bandwidth reduced below 100 Hz can cause a tracking error (deviation of tracking generator's output frequency from analyzer's tuning frequency), which eventually results in a level error. In this case, adjust the displayed signal level to the maximum with the T.G. FREQ. ADJ. control. Set the frequency span to 10 kHz, sweep time to relatively long, and step down resolution bandwidth from 300 Hz to 100 Hz, 30 Hz, and 10 Hz while adjusting the T.G. FREQ. ADJ. control until the maximum signal level is obtained.
- ⑨ To disable the tracking generator, press SHIFT OFF T.G. ; the indicator lamp above the T.G. key will go off.

5-2. FREQUENCY RESPONSE COMPENSATION USING A DISPLAY LINE

This paragraph describes frequency response compensation for the spectrum analyzer itself or an interconnecting cable (for filter response measurement, etc.) by using the TRACE function and a display line.

5-2-1. Compensation Using the SHIFT and MHz Keys

- ① Press the WRITE A key to place the analyzer in the WRITE A mode.
- ② Disconnect the device under test from the measuring setup and connect the TRACKING GENERATOR OUTPUT connector to the INPUT connector of the analyzer directly with a coaxial cable.
- ③ Press the REF. LEVEL key and adjust the reference level with the DATA knob and/or DATA step keys until the through frequency response is lowered to the level shown in the following figure:

REF.
LEVEL

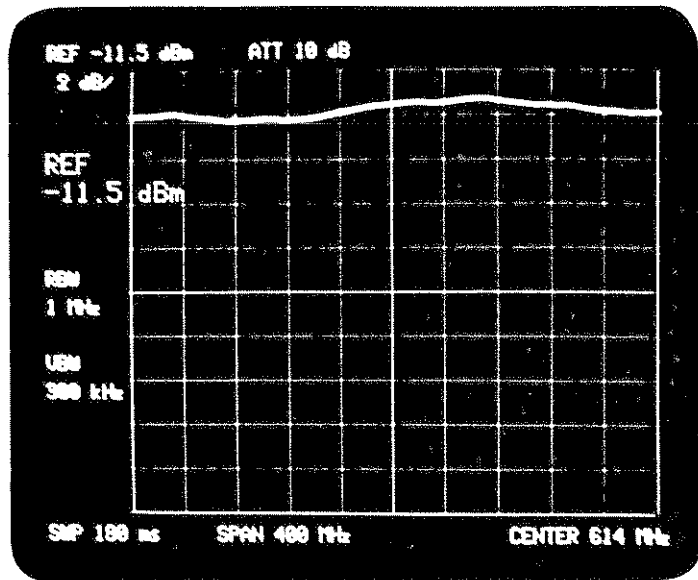

- ④ Press the DISPLAY LINE key to activate a display line. Using the DATA step keys and DATA knob, position the display line close to the through signal response. A broader dynamic range can be obtained as the display line is positioned closer to the through signal response.

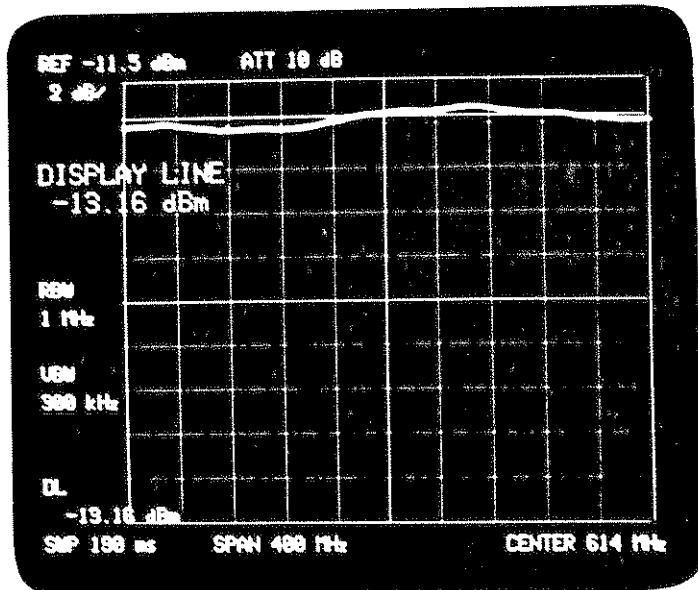
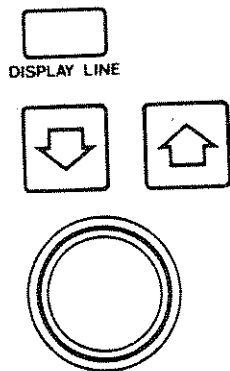

- ⑤ Analyzer's frequency response compensation is accomplished by pressing the SHIFT and MHz keys as below:

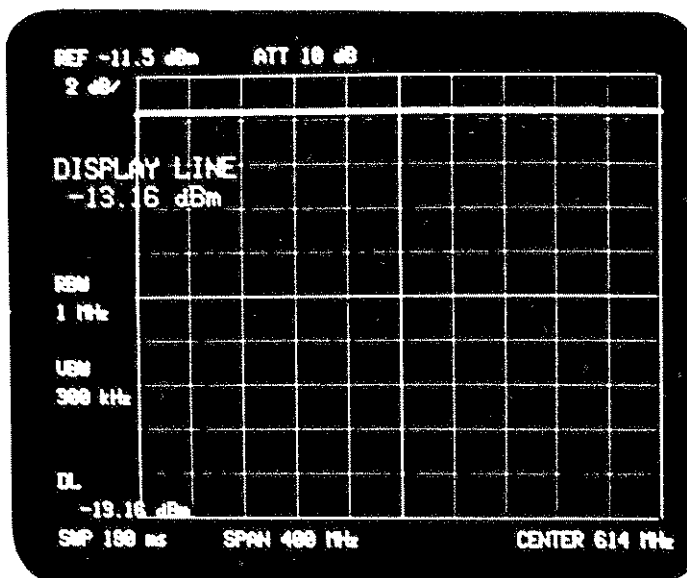
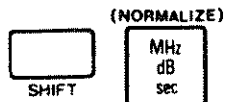

- ⑥ The compensation procedure described in steps ① through ⑤ above is an automatic version of the procedure using the B-DL → B and A-B → A keys which will be described in the following paragraph. Therefore, the analyzer is placed in the A-B → A mode after the frequency response compensation is completed and the indicator lamp on the A-B → A key lights.
- To disable frequency response compensation press the SHIFT and A-B → A keys to clear the A-B → A mode. Do not press  switch when this mode is used.

5-2-2. Compensation Using the B-DL → B Key

- ① Press the WRITE B key to place the analyzer in the WRITE B mode.
- ② Disconnect the device under test from the measuring setup and connect the TRACKING GENERATOR OUTPUT connector to the INPUT connector of the analyzer directly with a coaxial cable.
- ③ As described in Section 5-2-1, activate a reference level and display line, and position the display line close to the through signal response.

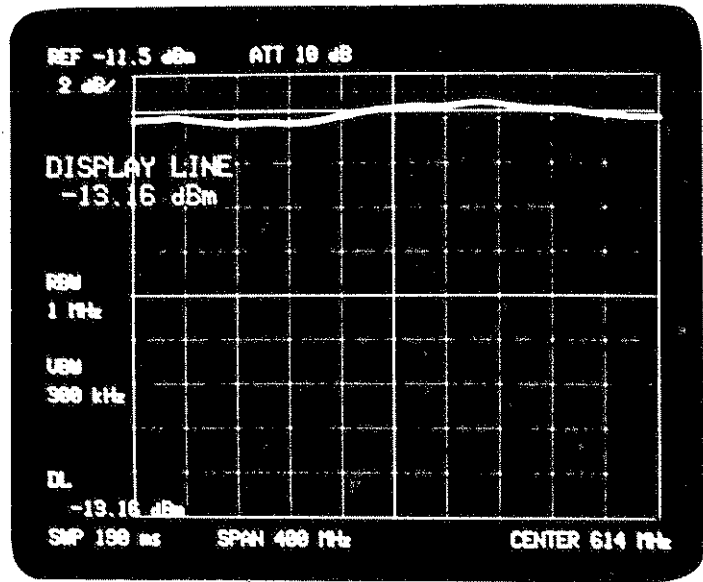
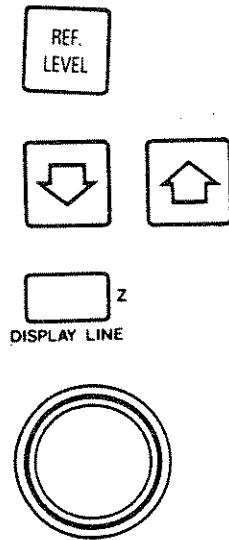



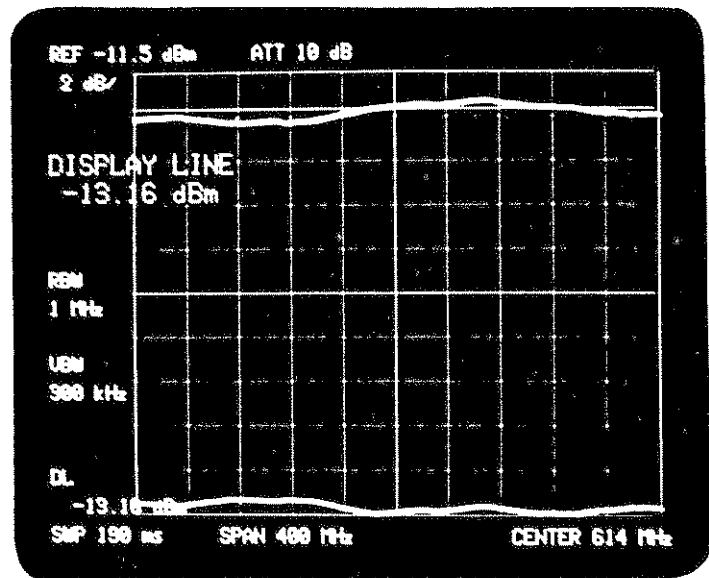



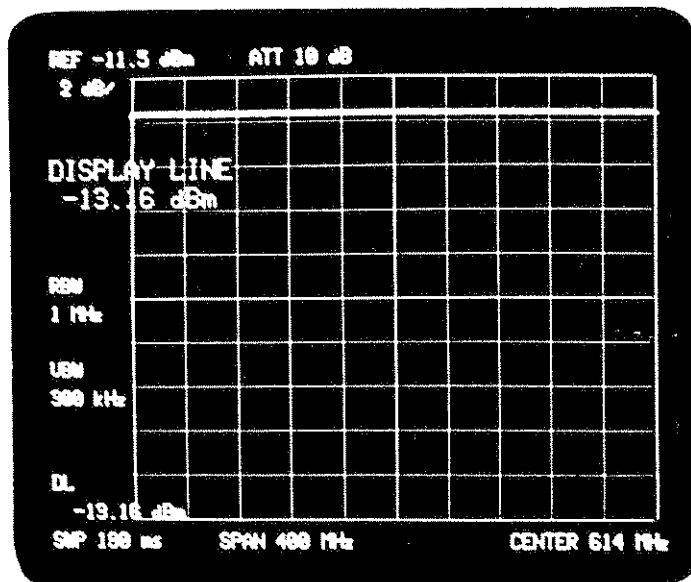
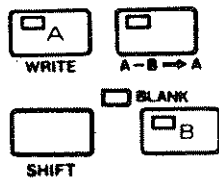

- ④ Press the B-DL → B key. The difference between the through signal response and the display line is written into memory B and then transferred to the CRT display. Memory B is placed in the VIEW B mode.



- ⑤ Press the WRITE A key and then A-B → A key. Connect the device under test to the measuring setup. The frequency response is now compensated and displayed on the CRT.

- ⑥ It is advisable that the SHIFT and B BLANK keys be pressed to erase trace B from the display.



- ⑦ Compensation for this frequency response is executed while the LED in the  switch illuminates. This mode is called as a normalize mode. In the normalize mode, the  key is not usable, since normalizing operations are performed on data for each sweep using memory B.
- ⑧ If the both display mode is desired while normalization is being performed, use memories A and A'. Note, however, that the previous contents of memory A' may be modified if normalization using  and  is performed (see 5-2-1). The contents of memory A' will not be affected if normalization is executed with the  key (See 5-2-2).
- ⑨ In the normalize mode, the alternate sweep feature is not available, since memory B is not usable. (See 4-14-6 ⑥, 6-2, and 7-3)
- ⑩ Operation of   clears the normalize mode, with the LED in the  key turned off.
- ⑪ Before executing normalization, select BLANK A' & BLANK B' mode, or VIEW A' & VIEW B' mode.

5-3. IF QUARTZ FILTER MEASUREMENT USING TRACKING GENERATOR

This paragraph provides an example of how to measure the insertion loss, ripple, 3 dB bandwidth, and attenuation of a communication purpose IF quartz filter using the tracking generator of TR4172.

5-3-1. Connecting the TR4172 and the Xtal filter

- (1) As shown in Figure 5-1, insert a DUT (filter) between the TR4172 TRACKING GENERATOR OUTPUT connector and the INPUT connector. This state of connection is called (a). The state of the two connectors being kept through with the DUT removed is called (b).

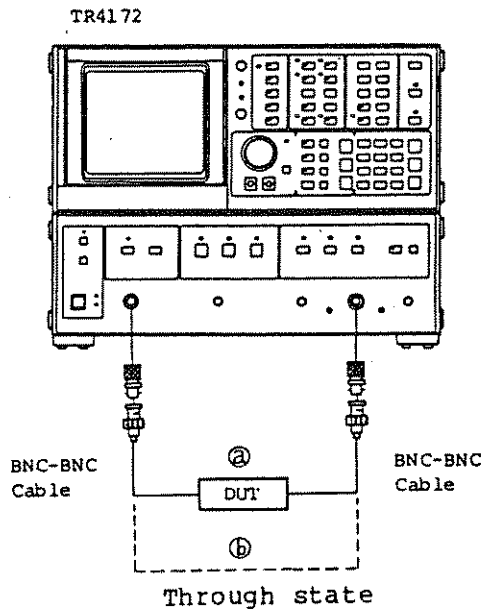

Fig. 5-1 Connecting the TR4172 and the Xtal filter

(2) Connection notes

- ① If the input and output impedances of the DUT differ from those of the TR4172 (50 ohms), match the impedances at the input and output.
- ② If the filter insertion loss is large, a satisfactorily wide dynamic range may not be achieved, in which case use a preamplifier (option 02) at the input.

5-3-2. Measuring procedure

The following procedure assumes that the DUT is a bandpass filter having the following characteristics:

- . Center frequency : 70 MHz
- . Pass bandwidth : 25 kHz
- . Insertion loss : Less than 5 dB
- . Ripple : Less than +1 dB
- . Attenuation : More than 70 dB

- ① Set up the analyzer for 70 MHz center frequency, 100 kHz frequency span, 0 dBm reference level, and 10 dB input attenuator. (Note)
- ② Activate the tracking generator output and check the T.G. output level with the DUT disconnected as shown in Figure 5-1. (b). The T.G. output level should be 0 dBm when the input attenuator is set 0 dB.

Since the frequency span is 100 kHz, the display will show a horizontal straight line. However, perform normalize as follows:

- ②-1 Press , then use or DATA knob to position the display line to an appropriate level near the top graticule.

- ②-2 Now press (NORMALIZE) in the WRITE A mode to adjust the response.

If the normalizing should be cleared, press SHIFT OFF A-B → A .

- ③ Connect the DUT as shown in Figure 5-1 (a). The insertion loss of the DUT is now read as the level difference between the marker point and display line.

Note: In the above example, the insertion loss is defined at the center frequency. In some cases, it may be defined at the peak or average of ripple.

- ④ Now the pass bandwidth of the DUT (3 dB down points both sides of the center frequency) is determined as follows:

- ④-1 Press MARKER , then use the Data knob to search for the 3 dB down point.

- ④-2 When the 3 dB point is found, press again.
- ④-3 Use the DATA knob to read the frequency at which the level is 0 dB. This frequency denotes the 3 dB pass bandwidth.
- ⑤ Ripple measurement
- ⑤-1 Press to position the maximum peak of the signal response to the reference level.
- ⑤-2 Press to change the vertical scale from 10 to 1 dB/div.

Note: Clear the adjustment mode if it has been selected.

- ⑤-3 Press , , then use the DATA knob to read the difference between the maximum and minimum peak level. This difference denotes the ripple level.

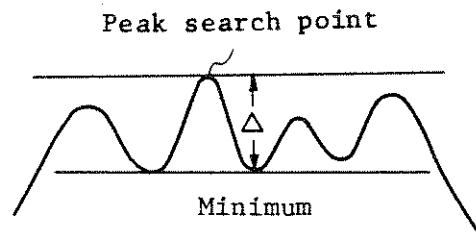

Fig. 5-2 Ripple level

- ⑥ Attenuation measurement
- ⑥-1 If the vertical scale was expanded through the above measurement, to 1 dB/div. for example, return it to 10 dB/div. Press (returns to 10 dB/div.)
- ⑥-2 If the insertion loss of the DUT is too great, the measuring dynamic range is reduced accordingly. To maintain the dynamic range, use a preamplifier at the input of the analyzer. (See Figure 5-2.) Whether the preamplifier is to be inserted in the input or output of the DUT will depend on the condition of the DUT itself.

The characteristics of the preamplifier (amplification factor, frequency response, noise figure, maximum input, VSWR, and input impedance) should be checked beforehand.

The preamplifier (option 02) is equivalent to ① in Figure 5-3. If the T.G. output level is too high, it can be attenuated by up to 50 dB at 10 dB steps as follows:

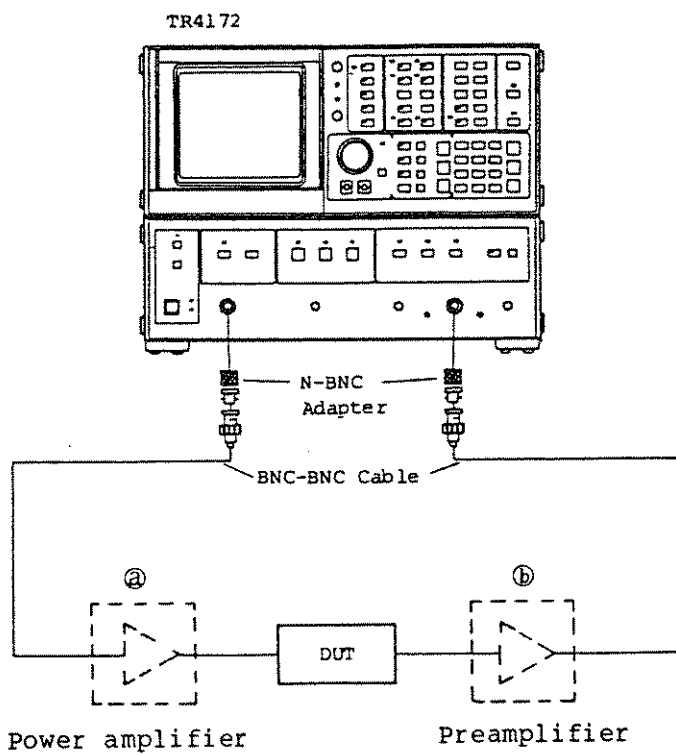

Fig. 5-3 Connecting filter and TR4172 via preamplifier

⑥-3 Connect the DUT to the instrument.

The following measurement information will be obtained for a band-pass filter (select an appropriate frequency span for this measurement):

Press , , , or , .

Using the delta marker, measure the attenuation (X dB).

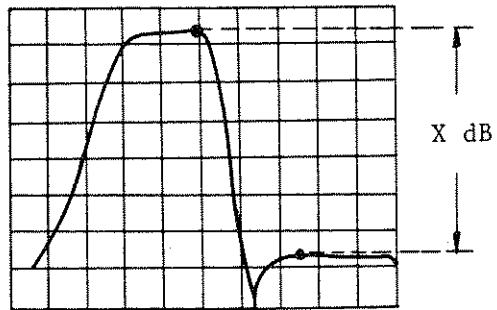

Fig. 5-4 BPF attenuation measurement

MEMO



A large, empty rectangular area with rounded corners, enclosed by a thin black border, intended for writing the memo's content.

SECTION 6
PHASE MEASUREMENT

6-1. PHASE MEASUREMENT PROCEDURE

This paragraph describes phase measurement procedure for amplifiers or filters. Before proceeding with phase measurement read SECTION 5 carefully.

- ① Set center frequency, frequency span, resolution bandwidth, sweep time, and other necessary conditions.
- ② Connect the TRACKING GENERATOR OUTPUT to the input of the device under test (amplifier or filter), and connect the output of the device under test to the INPUT of the analyzer. Activate the tracking generator.
- ③ Press the NORMAL key to measure the pass-band response of the device under test. According to the measurement result, select the appropriate T.G. LEVEL and INPUT ATT. level.
- ④ Then press the PHASE key to select the phase measurement mode. The display will present measurement range XX^0 / at its top left corner, and the indicator lamp just above the PHASE key will illuminate. In the Phase Measurement mode press the SWEEP TIME key to manually select the appropriate sweep time (the AUTO mode is programmed for amplitude measurement).
- ⑤ For more precise phase measurement without the affect of phase error of the measuring system, disconnect the device under test from the measuring setup, then connect the input and output cables by using an inline plug adapter to check the phase response of the measuring system itself.
- ⑥ If phase rotation is observed as shown in Figure 6-1, press the kHz G.D. OFFSET key to activate the electrical length.

PHASE

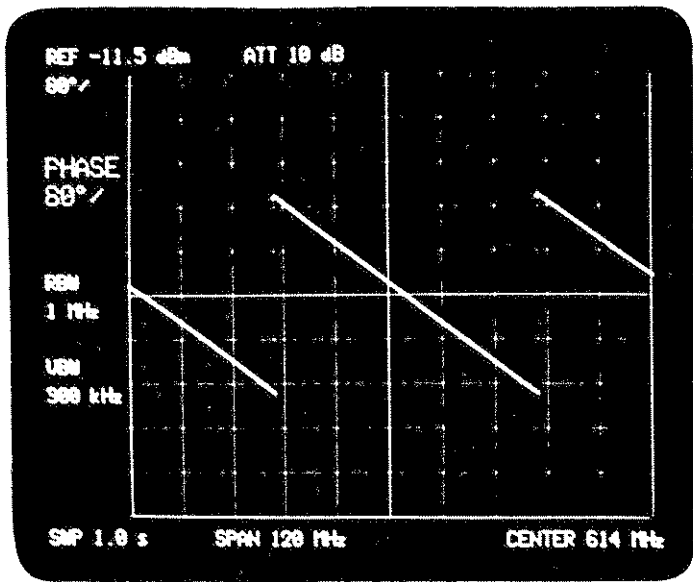

Fig. 6-1 Phase in rotation

Using the DATA knob or DATA step keys (DATA keyboard is not available for this adjustment), adjust the electrical length until a flat phase response is obtained. (See Figure 6-2.) When phase or group delay is activated, the MHz and kHz keys have the PHASE OFFSET and GROUP DELAY OFFSET functions respectively as named below the respective keys. Operation of the SHIFT key is not needed.

kHz
+dBm
msec
(G. D. OFFSET)

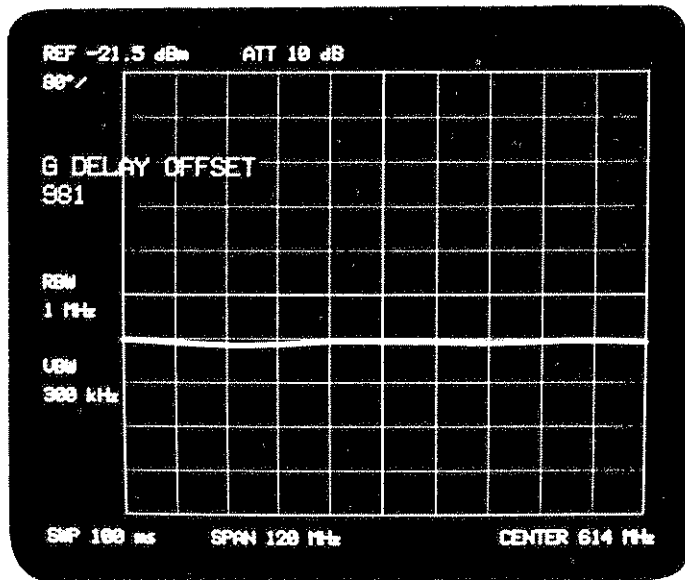

Fig. 6-2 Flat phase response

- ⑦ For fine adjustment of the electrical length, press the G.D. OFFSET key again. This will activate the G DELAY OFFSET FINE mode to permit fine adjustment of the electrical length.

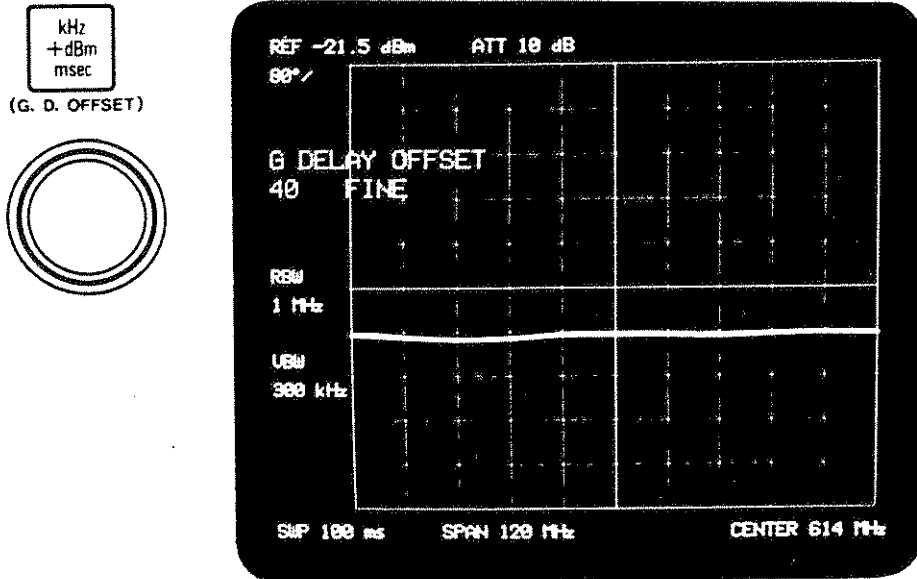

Fig. 6-3 Electrical length fine adjustment

- ⑧ Next press the MHz (PHASE OFFSET) key to activate phase offset, then position the phase response trace at the center of the vertical graticule.

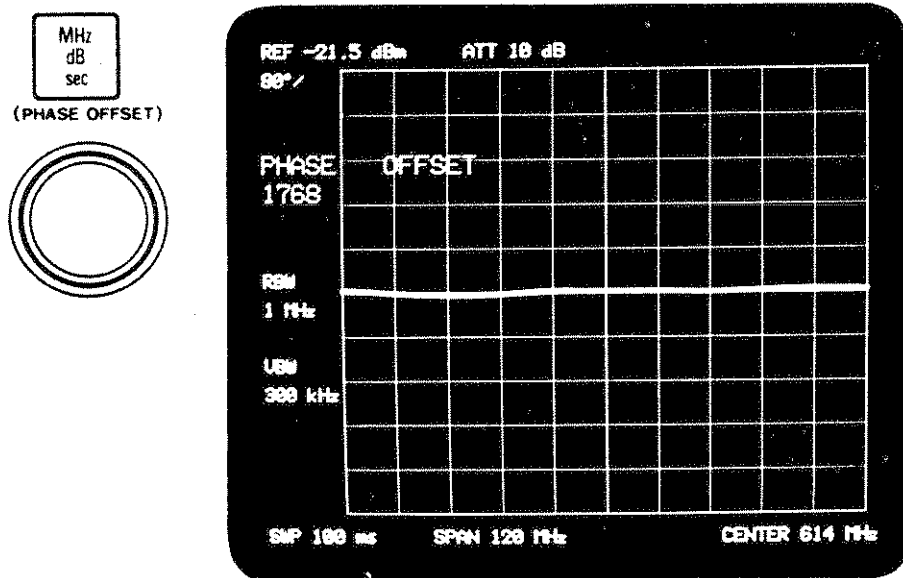

Fig. 6-4 Null phase offset

Verify that a straight line comes to the center of the vertical graticule as shown in Figure 6-4. If the line is not straight, activate

a display line, position it to the center of the vertical scale, and

press to normalize the frequency response.

- 9 Connect the device under test to the measuring setup, then press the PHASE key to start phase measurement for the device itself. Operation of the PHASE key will activate phase resolution. Using the DATA knob or DATA step keys, set phase resolution to the appropriate level.

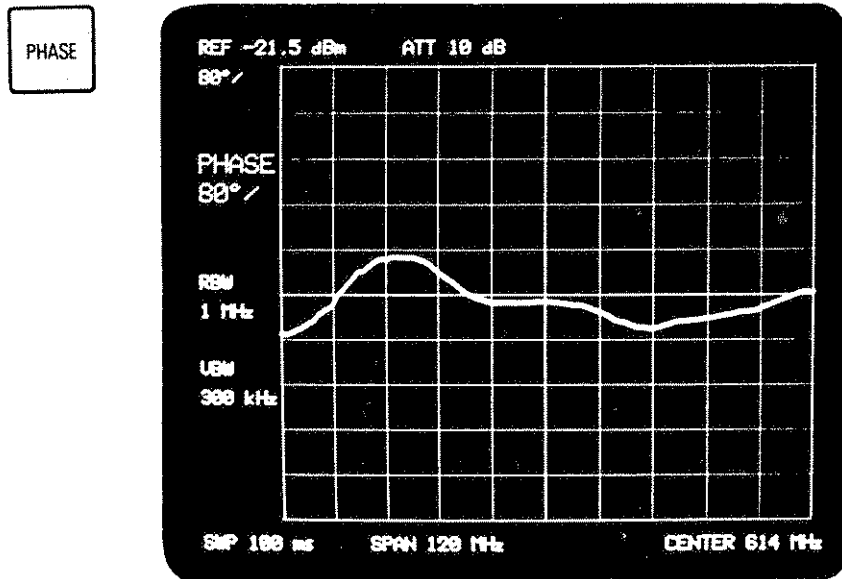

Fig. 6-5 Phase measurement

Note that a higher phase resolution may cause an overflow if the device under test has a relatively large phase rotation.

To observe phase variation, press the (G.D. OFFSET) key and then adjust the electrical length and phase response with the DATA knob. Press the PHASE key again. The phase variation is now enlarged on the display.

6-2. PHASE AND AMPLITUDE ALTERNATE SWEEP (SHIFT, H)

SHIFT D. T. A. P. H performs phase and amplitude measurements alternately and writes the results into trace memories B and A respectively and then transfers it to the display.

When this mode is selected, the indicator lamps on the WRITE A, WRITE B, PHASE, and NORMAL keys light.

To disable alternate sweep press SHIFT D. T. OFF HOLD.

The alternate sweep should not be activated when frequency response compensation using a display line in Section 5 is used.

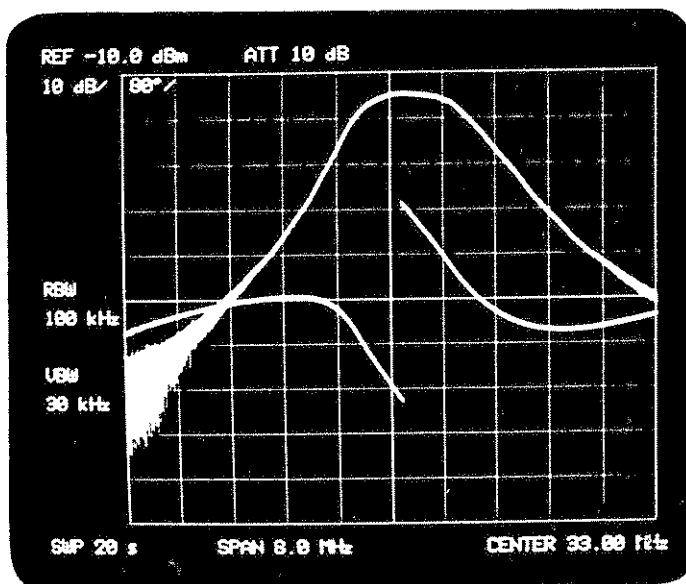
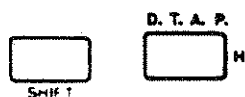

Fig. 6-6 Phase and amplitude alternate sweep

6-3. SAW FILTER PHASE RESPONSE MEASUREMENT

6-3-1. Connecting a Saw Filter to the TR4172

- (1) As shown in Figure 6-7, insert a DUT (filter) between the TR4172 TRACKING GENERATOR OUTPUT connector and the INPUT connector. This state of connection is called (a). The state of the two connectors being kept through with the DUT removed is called (b).
- (2) In general, various types of SAW filter are available with input/output impedance of 50 Ω , 75 Ω , 200 Ω , 300 Ω , 1k Ω , and more than 1 k Ω . Before measurement, use an appropriate measure to obtain impedance matching between the SAW filter and the instrument. A schematic diagram of the recommended matching network can be obtained from the manufacturer of the filter.

- (3) A saw filter usually has a 20 dB insertion loss. To compensate for this loss, some filters contain an amplifier. If a filter with a self-contained amplifier is to be used, note the maximum output level of the tracking generator.
- (4) Use the shortest possible cables.

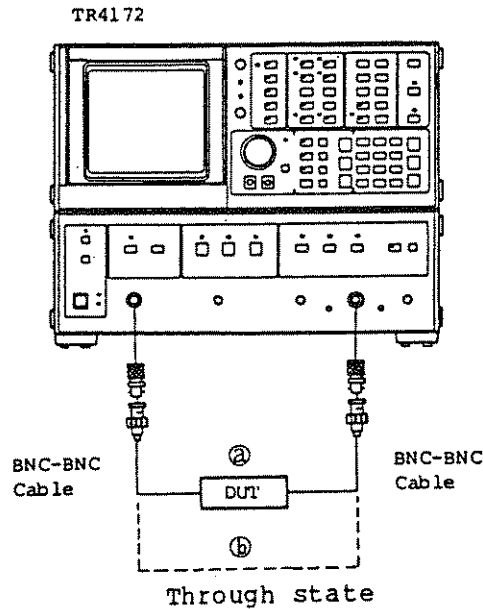

Fig. 6-7 Measuring system setup

6-3-2. Measuring Procedure

- ① Set up the center frequency, sweep span, input condition, and other necessary parameters.
- ② Remove the DUT from the connection cable to place the TR4172 TRACKING GENERATOR OUTPUT connector and the INPUT connector in a through state as indicated by (b) in Figure 6-7.
- ③ Press the kHz (G.D. OFFSET) key to obtain a flat phase response. If fine adjustment is required, press the kHz key again to select the G.D. OFFSET FINE mode and perform fine adjustment.
- ④ Press the MHz (G.D. OFFSET) key to position the phase response trace to the center of the vertical scale.
- ⑤ Connect a filter in the through state as indicated by (a) in Figure 6-7, then press the PHASE key; the phase response of the DUT (filter) will be displayed. Display resolution can be increased with the DATA knob or DATA step keys (80, 40, 20, 8, ... 0.2 deg/div.).

Figures 6-8 and 6-9 show respectively the amplitude and phase responses of the same filter.

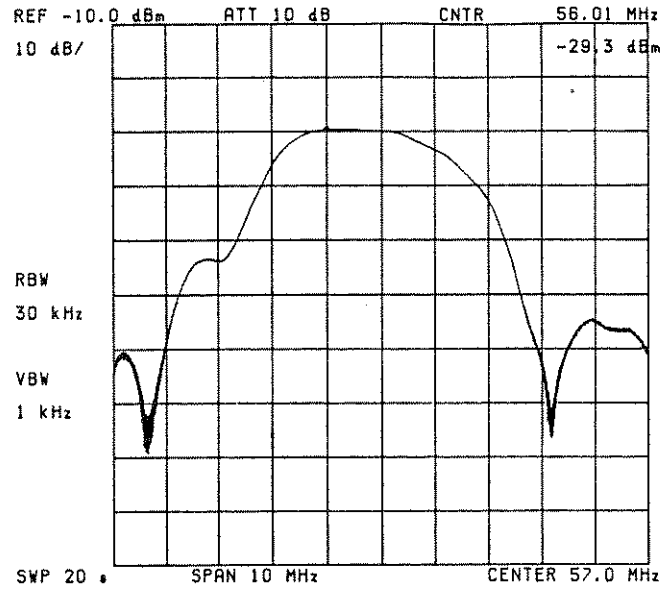

Fig. 6-8 Amplitude response of a filter

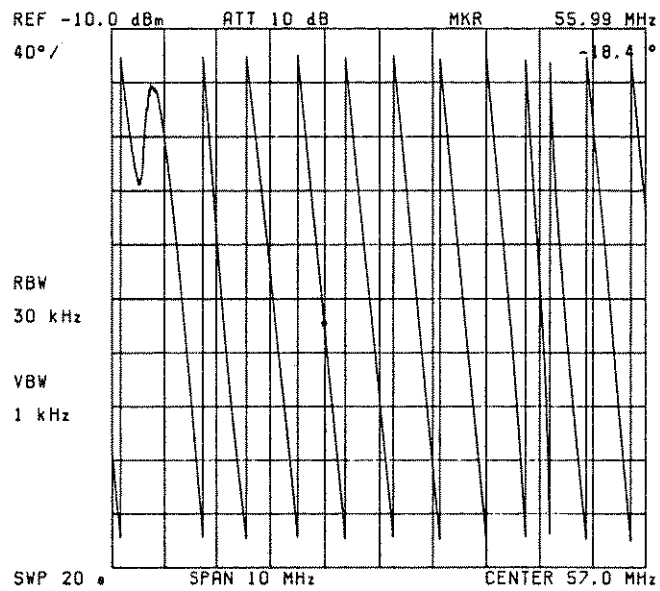

Fig. 6-9 Phase response of the filter

6-3-3. Phase Display Example

Figure 6-10 shows a phase response display example for a saw filter covering a frequency range between 50 and 60 MHz.

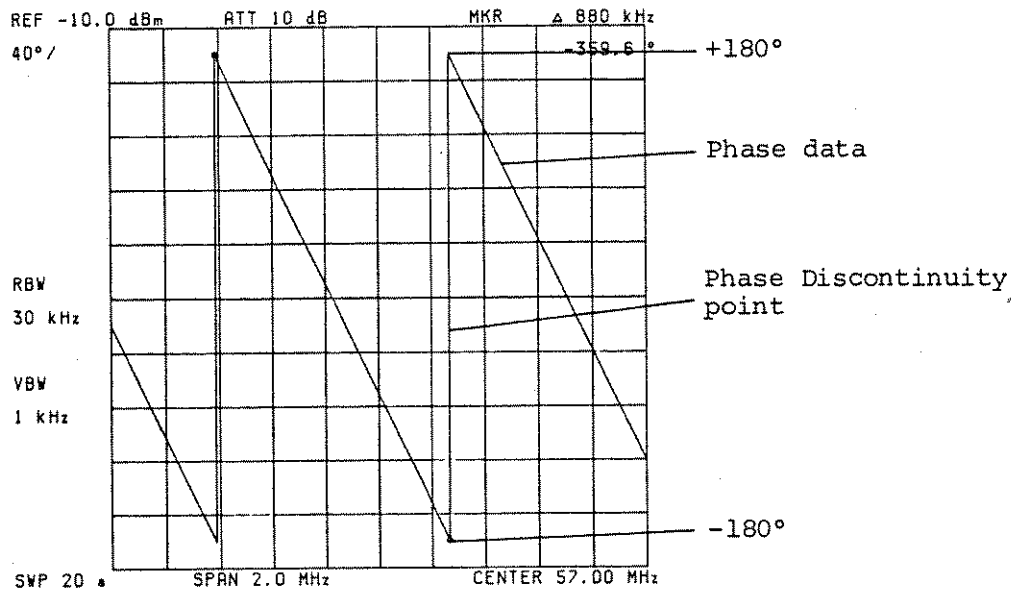
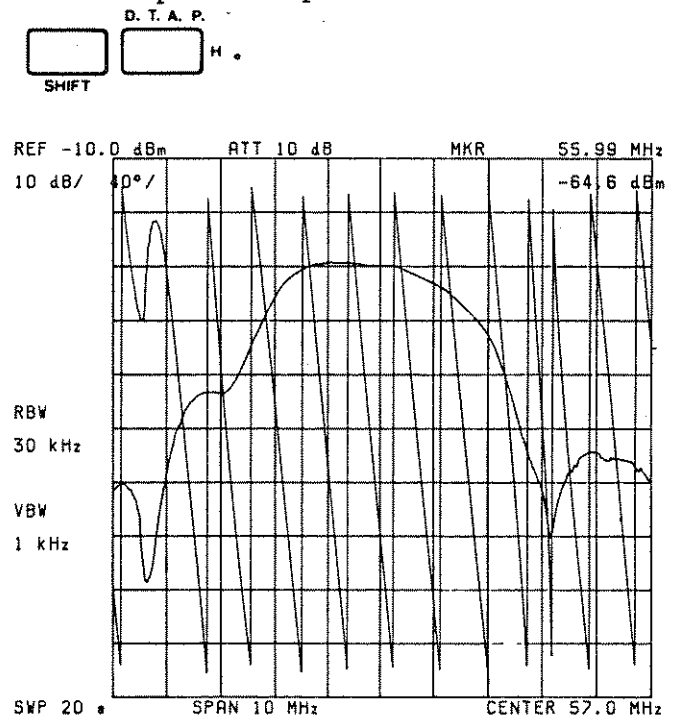
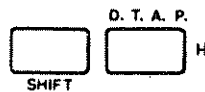

Fig. 6-10 Phase response display example

- (1) The example shows that the phase lag increases with frequency.
- (2) The vertical lines indicate discontinuity points on the response occurring at $+180^\circ$ and -180° .
- (3) The center horizontal line (5 div. lines from the top graticule) indicates the zero phase.
- (4) Numeric readouts indicate measurement conditions.
- (5) This example shows the the filter has a phase lag of about 360° over about a 880 kHz frequency band. For more precise measurement, use the delta marker mode.

6-3-4. Usage of the Alternate Sweep

- ① Connect DUT to the instrument. Press the NORMAL key and measure the amplitude response of the DUT to set up necessary measurement conditions.
- ② According to the procedure in 6-3-2, adjust electrical length and determine phase resolution.
- ③ Use the DATA knob to select the shortest sweep time which does not affect the phase data.
- ④ To obtain the amplitude and phase responses at the same time on the display, press H .



- ⑤ To restore the normal measurement mode, press U . This will place one of trace memories A and B in the write mode and the other in the view mode. To clear unnecessary information, place one of the trace memories in the write mode, and the other in the blank mode.

MEMO



A large, empty rectangular area with rounded corners, enclosed by a thin black border, intended for writing the memo's content.



SECTION 7
GROUP DELAY MEASUREMENT

7-1. GROUP DELAY MEASUREMENT PROCEDURE

This paragraph describes group delay measurement procedure for amplifiers or filters.

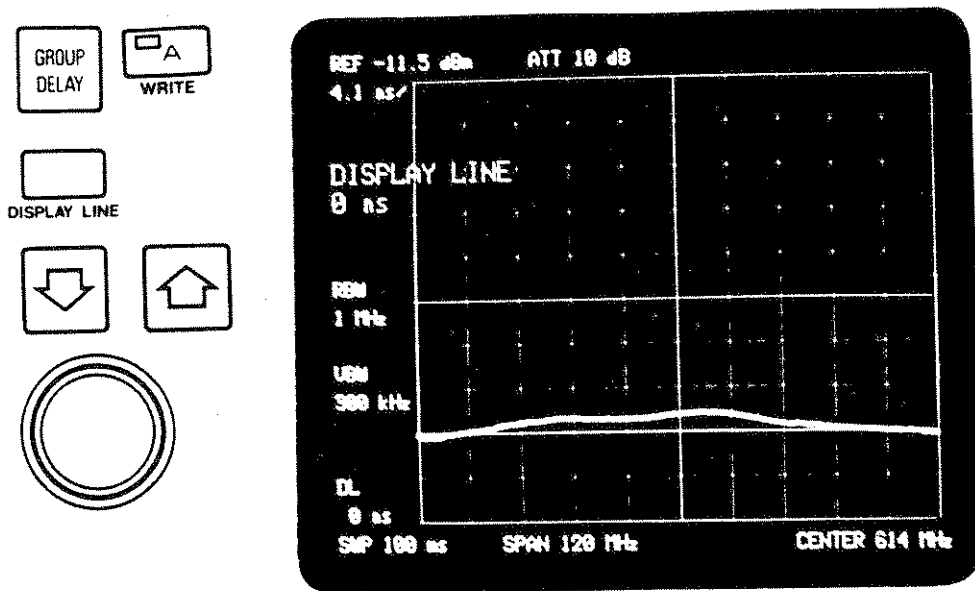
- ① Connect the TRACKING GENERATOR OUTPUT to the input of the device under test (filter or amplifier) and connect the output of the device to the INPUT connector of the analyzer.
- ② Press the T.G. key to activate the tracking generator.
- ③ Press the NORMAL key to measure the pass-band response of the device under test. According to the measurement result, select the appropriate T.G. level and INPUT ATT. level.
- ④ The group delay response of the device under test can be observed by pressing the GROUP DELAY key. The display will also present delay time per vertical division as XX ns/ (or ps/ or ms/) in the top left display area.
- ⑤ For more precise group delay measurement without the affect of the group delay of the measuring system itself, press the WRITE A key to write the group delay response of the measuring system into trace memory A.
- ⑥ Then press the DISPLAY LINE key to activate a display line on the CRT, and use the DATA step keys and DATA knob to position the display line as close to the group delay response trace as possible.



⑦ To clear the group delay of the measuring system press  .

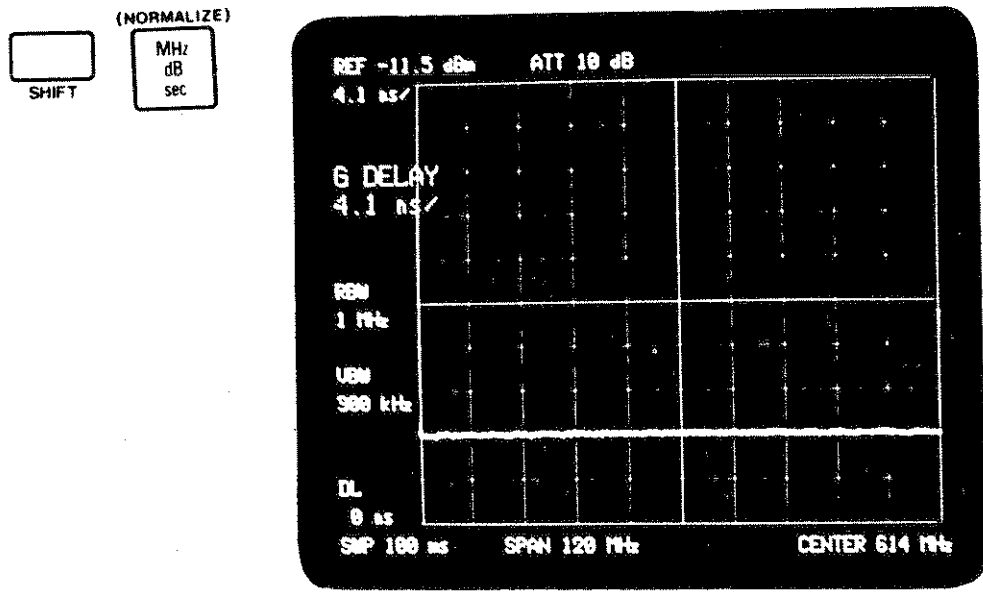



Fig. 7-1 Clearing the measurement system group delay

To cancel this group delay clear mode, press  .

⑧ For still more precise measurement of group delay, use averaging. (See 4-14-1.)

After pressing the WRITE A key in step ⑤ above, press the SHIFT and k (AVG. ON) keys to initiate averaging.

When the programmed number of averagings is reached, follow steps

- ⑥ and ⑦ above, then press the SHIFT and m (AVG. OFF) keys to disable averaging.
- ⑨ To obtain a higher resolution in group delay measurement, press the GROUP DELAY key to activate resolution.
- Group delay resolution can be increased by turning the DATA knob clockwise or operating the UP DATA step key. The DATA keyboard is not available for resolution control.
- A too high resolution can cause overflow. If overflow occurs, press the G.D. OFFSET key to activate the electrical length and then adjust the electrical length with the DATA knob or DATA step keys to add offset to the group delay.
- ⑩ During group delay measurement, press the PHASE key from time to time to check the phase response for overflow. Group delay will be indefinite on the overflow.
- If phase rotation is observed, press the (G.D. OFFSET) key and adjust group delay offset with the DATA knob or DATA step key until phase rotation is eliminated.
- ⑪ If high-resolution measurement suffers from poor signal-to-noise ratio, press the VIDEO BW key to narrow the video bandwidth. For group delay measurement, manually select a relatively long sweep time, do not use AUTO mode.

7-2. GROUP DELAY MEASUREMENT EXAMPLE

This provides a group delay measurement example using a filter as the device under test.

- ① Connect the TRACKING GENERATOR OUTPUT to the input of the device under test and connect the output of the device to the INPUT -1 of the analyzer.

T.G.

NORMAL

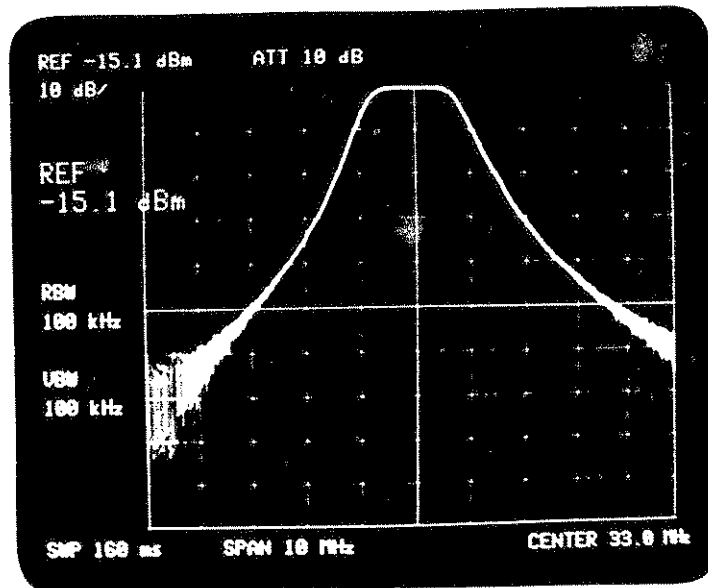

Fig. 7-2 Normal mode signal response

- ② Press the T.G. key to activate the tracking generator.
- ③ Press the NORMAL key to measure the pass band response of the device under test. According to the measurement result select the appropriate T.G. level and INPUT ATT. level (Figure 7-2).
- ④ Disconnect the device under test from the measuring setup and connect the input and output cables using an inline plug adapter to check the through frequency response.
- ⑤ The through phase response can be observed by pressing the PHASE key (Figure 7-3).

PHASE

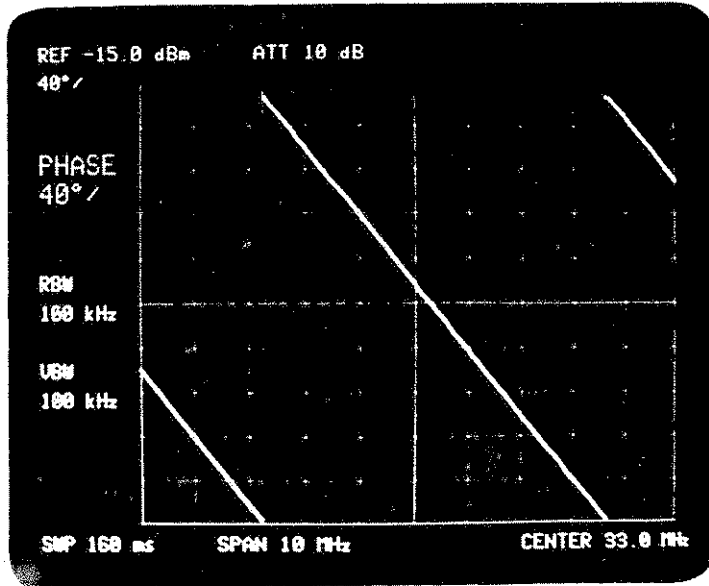

Fig. 7-3 Through phase response

- ⑥ If phase rotation is observed, press the [G.D. OFFSET] key to activate the electrical length. Then adjust the phase response to flat with the DATA knob or DATA step keys (Figure 7-4).

If the key is pressed under these setup, group delay offset value is set to 0 ps. Consequently, when group delay value at marker point is to be displayed, the value adding subsequently entered group delay offset is displayed at the active function area on the left side of CRT.

- ⑦ Next press the (PHASE OFFSET) key to enable entry of phase offset. Position the phase response trace to the center of the vertical graticule with the DATA knob or DATA step keys (Figure 7-5).

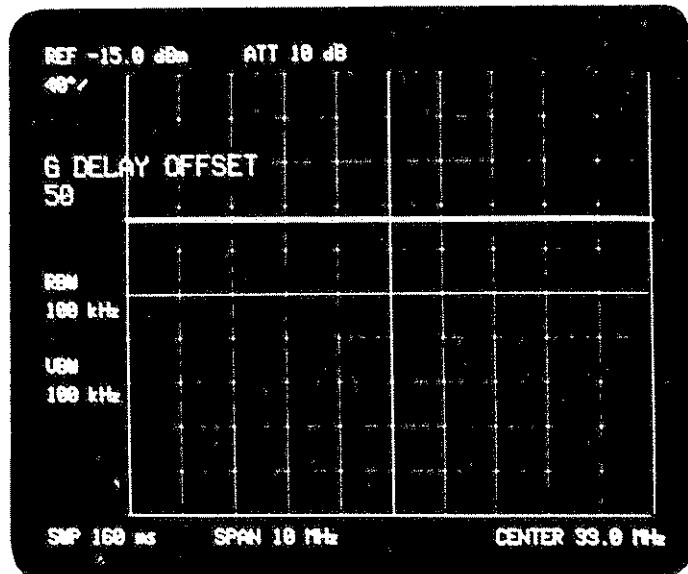
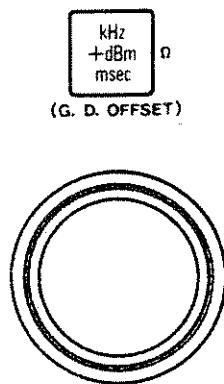

Fig. 7-4 Elimination of phase rotation

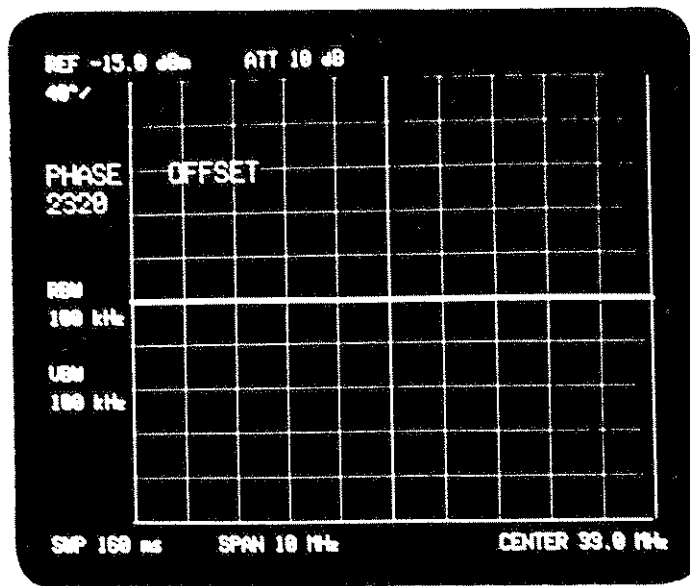
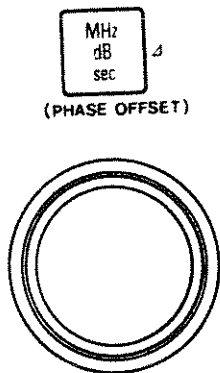

Fig. 7-5 Positioning the phase response trace to the center of the vertical graticule

- ⑧ Connect the device under test (filter) to the measuring setup to observe its phase response (Figure 7-6).

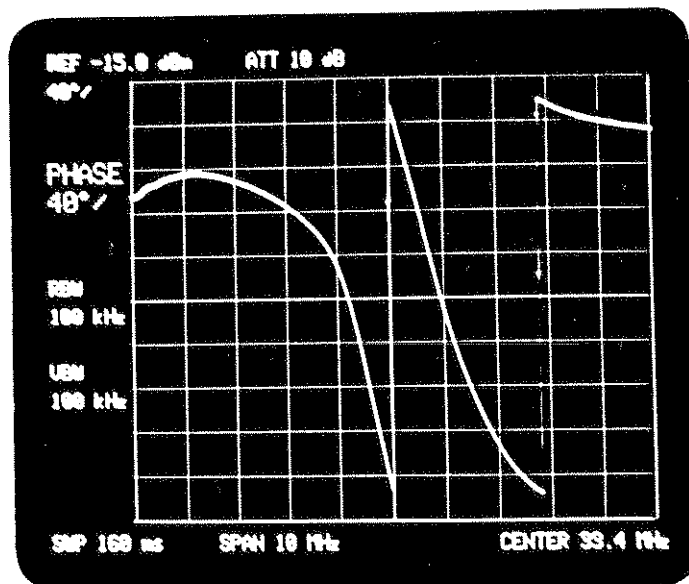

Fig. 7-6 Filter's phase response

- ⑨ The group delay of the filter can be observed by pressing the GROUP DELAY key (Figure 7-7).

GROUP
DELAY

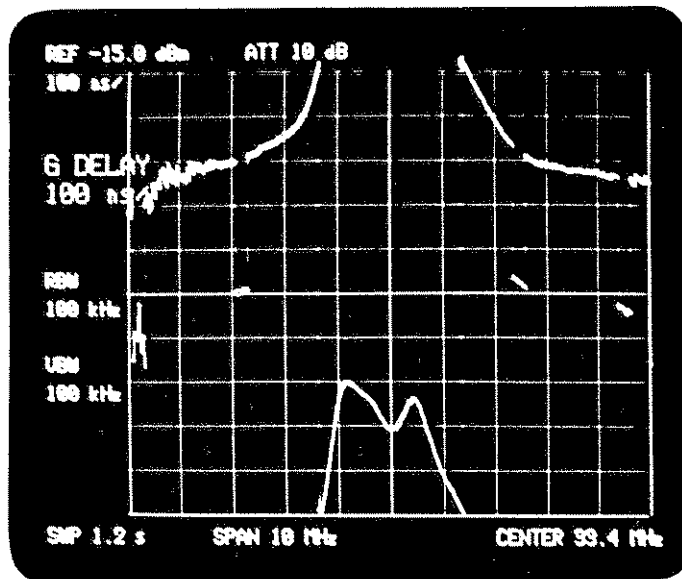

Fig. 7-7 Group delay measurement

- ⑩ To obtain higher resolution for group delay measurement, resolution for phase measurement must be increased.
Press the PHASE key to activate phase. To increase phase resolution turn the DATA knob clockwise.
The phase readout (XX°) in the active function display area will increase (Figure 7-8).

PHASE

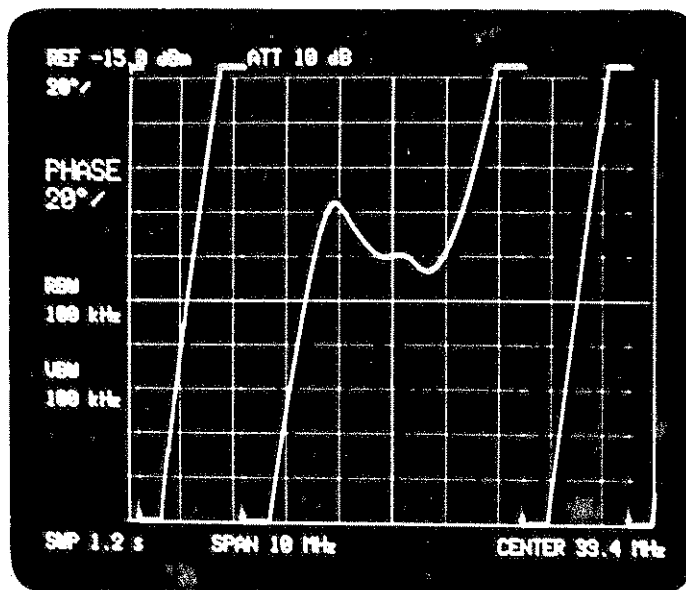
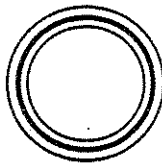

Fig. 7-8 Increasing phase resolution

- ⑪ If phase overflow occurs in the pass band due to the increased phase resolution, press the (G.D. OFFSET) key to activate group delay offset. Then adjust the phase slope in the pass bandwidth with the DATA knob.
- ⑫ The group delay of the device under test can be observed by pressing the GROUP DELAY key (Figure 7-9).
- ⑬ For more precise group delay measurement, write the group delay of the through response into trace memory A at the same resolution (See 7-1 (5), (6)), bring the display line close to the through response trace, then press the SHIFT and MHZ keys to eliminate the group delay of the measuring system itself. Use of the averaging mode (See 7-1 (8)) will provide still more precise measurement.
- ⑭ If a greater signal-to-noise ratio is desired, press the VIDEO BW key to narrow the video bandwidth. At this time press the SWEEP TIME key and select a relatively long sweep time.

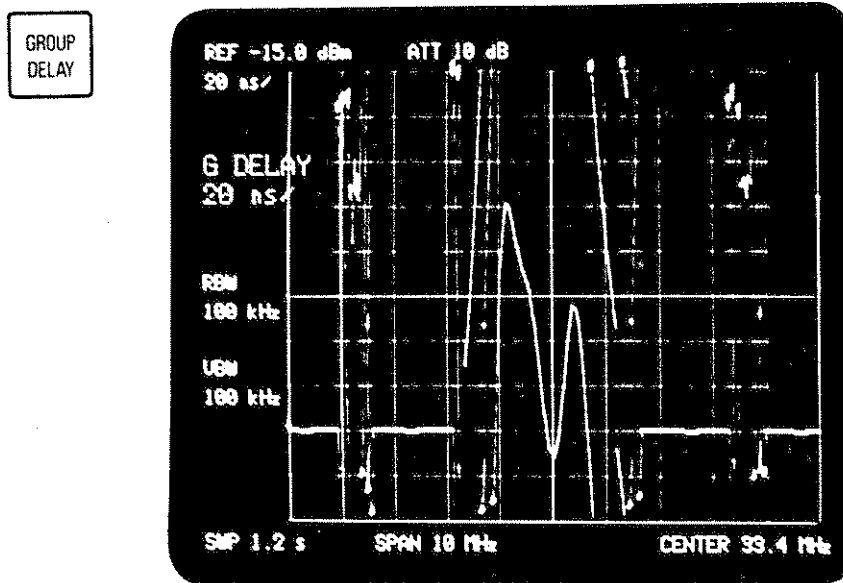

Fig. 7-9 Group delay measurement

A much greater signal-to-noise ratio will be obtained by selecting the averaging mode (press SHIFT and AVG. ON.) after connecting the device under test.

7-3. GROUP DELAY AND AMPLITUDE ALTERNATE SWEEP (SHIFT, M)

SHIFT,M performs group delay and amplitude measurements alternately. The results are written into memories B and A respectively and then transferred to the display simultaneously. The indicator lamps on the GROUP DELAY, NORMAL, WRITE A, and WRITE B keys will light.

To disable the alternate sweep mode press the SHIFT and \perp keys.

The group delay and amplitude alternate sweep mode is usable together with the frequency response compensation mode (page 7-1) using the SHIFT and MHZ keys. Followings are the measurement procedure example using a filter as the device under test.

- ① Connect the TRACKING GENERATOR OUTPUT to the device under test (filter or amplifier) and connect the output of the device to the INPUT-1 connector of the analyzer.
- ② Press the T.G. key to activate the tracking generator.
- ③ Press the NORMAL key to measure the frequency response, and select appropriate T.G. level and INPUT ATT. level.
- ④ Disconnect the device under test from the measuring setup and connect the input and output cables to check the through frequency response.
- ⑤ Press the DISPLAY LINE key to activate display line on the CRT, and use the DATA step keys and DATA knob to position the display line as close to the through frequency response as possible.
- ⑥ Press the SHIFT and M keys to specify group delay and amplitude alternate sweep mode.
- ⑦ If the SHIFT and MHZ keys are pressed at this time, both response traces of amplitude and group delay are normalized. In this case, amplitude response trace is normalized on the display line and group delay response trace is normalized on the second lowest graticule line of the CRT, respectively.
- ⑧ Observe the device response traces of amplitude and group delay simultaneously.

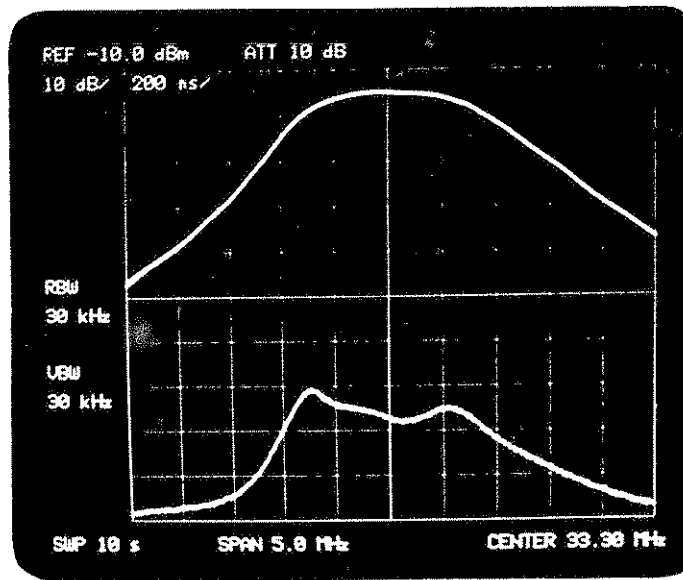
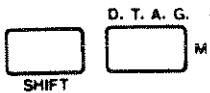

Fig. 7-10 Group delay and amplitude alternate sweep

7-4. APERTURE CONTROL

In general, a higher group delay resolution can cause lower signal-to-noise ratio. However, group delay resolution can be increased without sacrificing S/N ratio by increasing aperture. Aperture means ΔF in the group delay equation $\Delta\theta/\Delta F$.

On the TR4172, aperture is normally set up as follows:

$$\Delta F = \frac{24}{1000} \times \text{frequency span}$$

Constant 24/1000 in the above formula can be increased up to 192/1000 at four steps as follows:

- ① Operation of the GROUP DELAY and Hz keys will activate the aperture. APERTURE 24 will be shown in the active function display area on the CRT to indicate that the current aperture is $\frac{24}{1000}$ x (frequency span).
- ② Select the appropriate aperture from 24, 48, 96, or 192 with the DATA knob or DATA step keys. The numeric data keyboard is not usable for aperture selection.
Once aperture is increased, resolution can be increased without sacrificing S/N ratio.
For example, if the resolution is 100 ns/div. with the aperture 24/1000, the resolution can be increased to 50 ns/div. by changing the aperture to 48/1000.
- ③ As the aperture is increased, the effective range of the screen graticule is gradually reduced accordingly.
This is because (aperture/2 - 12) points out of 1001 points on the frequency axis are lost at both side ends of the graticule as aperture is increased.
When aperture is increased to 192, the effective range of the graticule is lessened by one division on each end of the graticule.
- ④ Operation of the GROUP DELAY key will clear the active aperture mode and restore the active group-delay resolution mode.

GROUP
DELAY

Hz
-dBm
μsec

(APERTURE)

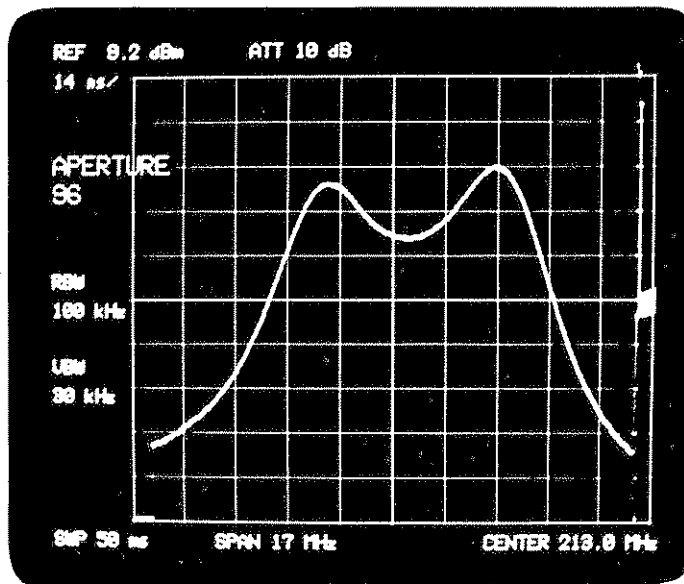
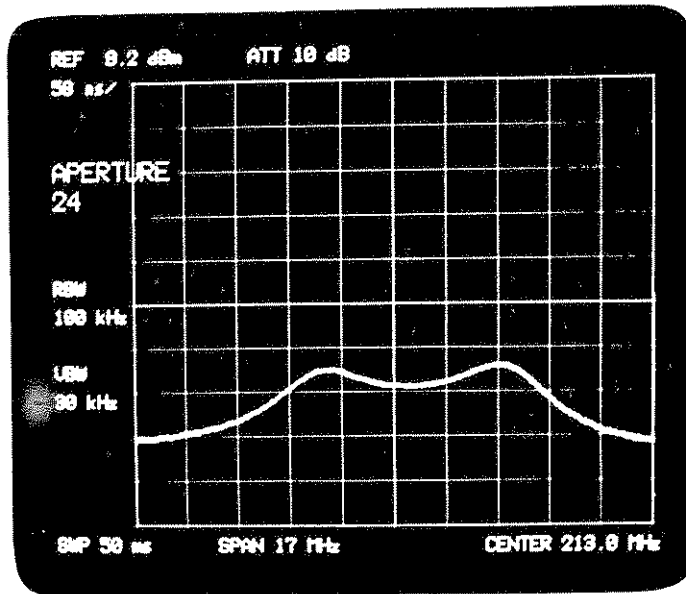

During group delay measurement, the signal response trace on the display may produce spike noise as shown below.

To eliminate this noise, either of the following methods may be used:

- (1) Select a sufficiently long sweep time.
- (2) Perform electrical length correction to eliminate discontinuity of the phase response. Now the ripple of relative group delay is measured. Note that an absolute delay time cannot be measured.

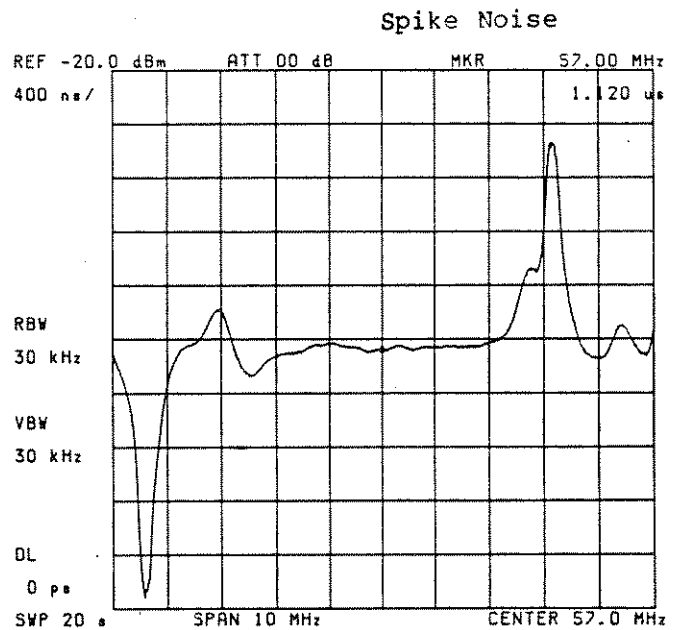
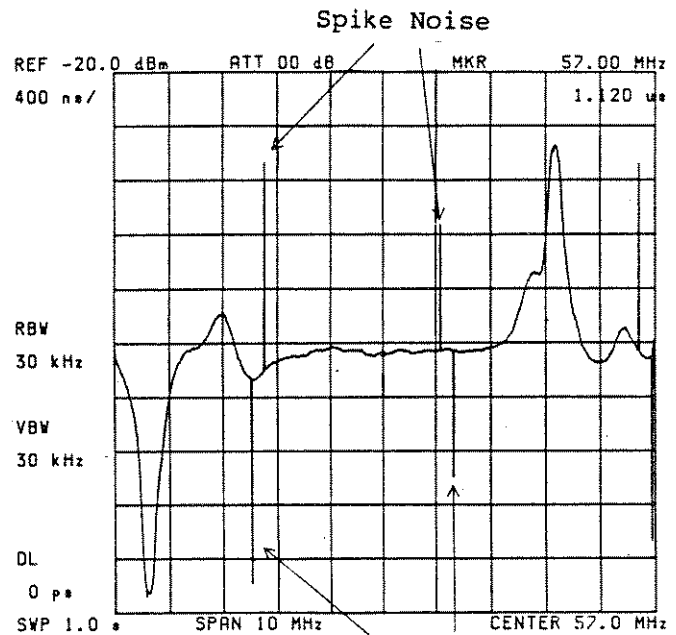

MEMO



A large, empty rectangular area with rounded corners, enclosed by a thin black border, intended for writing the memo's content.

SECTION 8
ATTACHMENT TO GPIB AND PROGRAMMING SUPPORT

8-1. INTRODUCTION

The TR4172 Spectrum Analyzer is attached to the GPIB (specified in IEEE Standard 488-1978) via the GPIB interface (standard supply). This section describes the specifications and operations of the GPIB interface.

* GPIB: General Purpose Interface Bus

8-2. GPIB OVERVIEW

GPIB enables interfacing of a measuring instrument with its controller or other peripheral devices through simple cabling (bus line).

Compared with other interfacing methods, GPIB provides better expansibility, operability and compatibility with other products both electrically and mechanically, thus enabling construction of various grades of instrumentation systems through a single bus cabling.

In a GPIB system, each system device on the bus must have its own address. Each device can be designated for one or two functions out of controller, talker, and listener functions. During system operation, only one talker may send data on the bus, while one or more listeners can receive the data.

The controller designates talker and listener addresses to cause the talker to send data to the listener or cause itself (talker) to send measurement condition data, etc. to the listener.

System devices are linked together with asynchronous, bidirectional bus (8 data lines), through which bit parallel, byte serial data is transferred. Due to its asynchronous nature, the bus permits attachment of both high-speed and low-speed devices at a time.

Data transferred between devices includes measurement data, measurement conditions (programs), or commands all in ASCII character format.

In addition to the 8 data lines, GPIB includes three handshake lines to control asynchronous data flow between devices and five control lines to control information flow on the data bus.

The handshake lines transfer the following signals:

Data Valid (DAV): Indicates validity of transferred data.

Not Ready For Data (NRFD): Indicates data receive not ready state.

Not Data Accepted (NDAC): Indicates the data receive completion state.

The control lines transfer the following signals:

Attention (ATN): Used to discriminate address or command data on the data bus from other information.

Interface Clear (IFC): Clears the interface.

End or Identify (EOI): Indicates the end of data transfer.

Service Request (SRQ): Used by any device to request the controller for service.

Remote Enable (REN): Used to place a remote programmable device in the remote control mode.

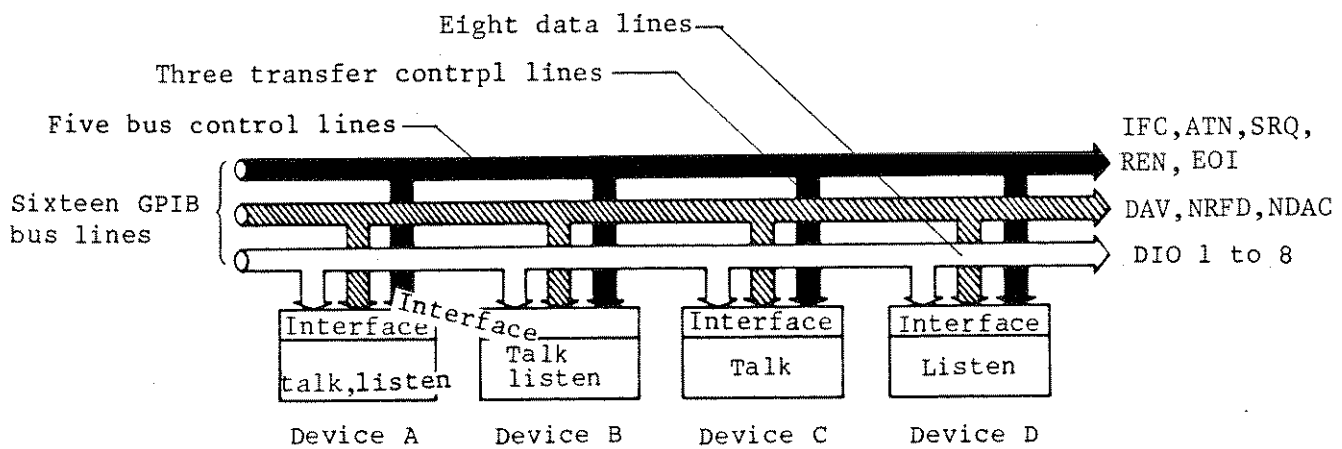

Fig. 8-1 Concept of GPIB

8-3. SPECIFICATIONS

8-3-1. GPIB Specifications

Standard	: IEEE Standard 488-1978
Code	: ASCII (binary code with packed format)
Logical levels	: 0 (HIGH): +2.4 V or more 1 (LOW) : +0.4 V or less
Signal line termination	: 16 bus lines terminated as shown below:

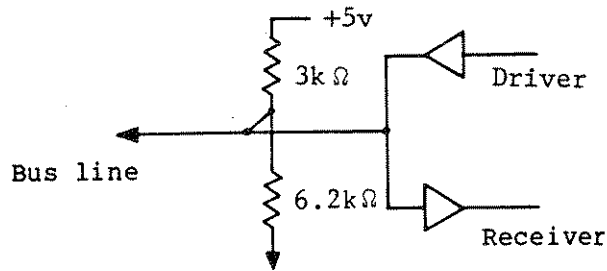

Fig. 8-2 Signal line termination

- Driver : Open collector output
LOW output: +0.4 V or less, 48 mA
HIGH output: +2.4 V or more, -5.2 mA
- Receiver : LOW at +0.6 V or less
HIGH at +2.0 V or more
- Bus cable length : Total bus cable length should be less than
2 meters x (number of attached devices) and
must not exceed 20 meters.
- Address designation: Up to 31 talker and listener addresses can
be designated with the rear ADDRESS
switch. After address setting, operation
of the MASTER RESET key is required.
- Connector : 24 pin GPIB connector
57-20240-D35A (Amphenor or equivalent)

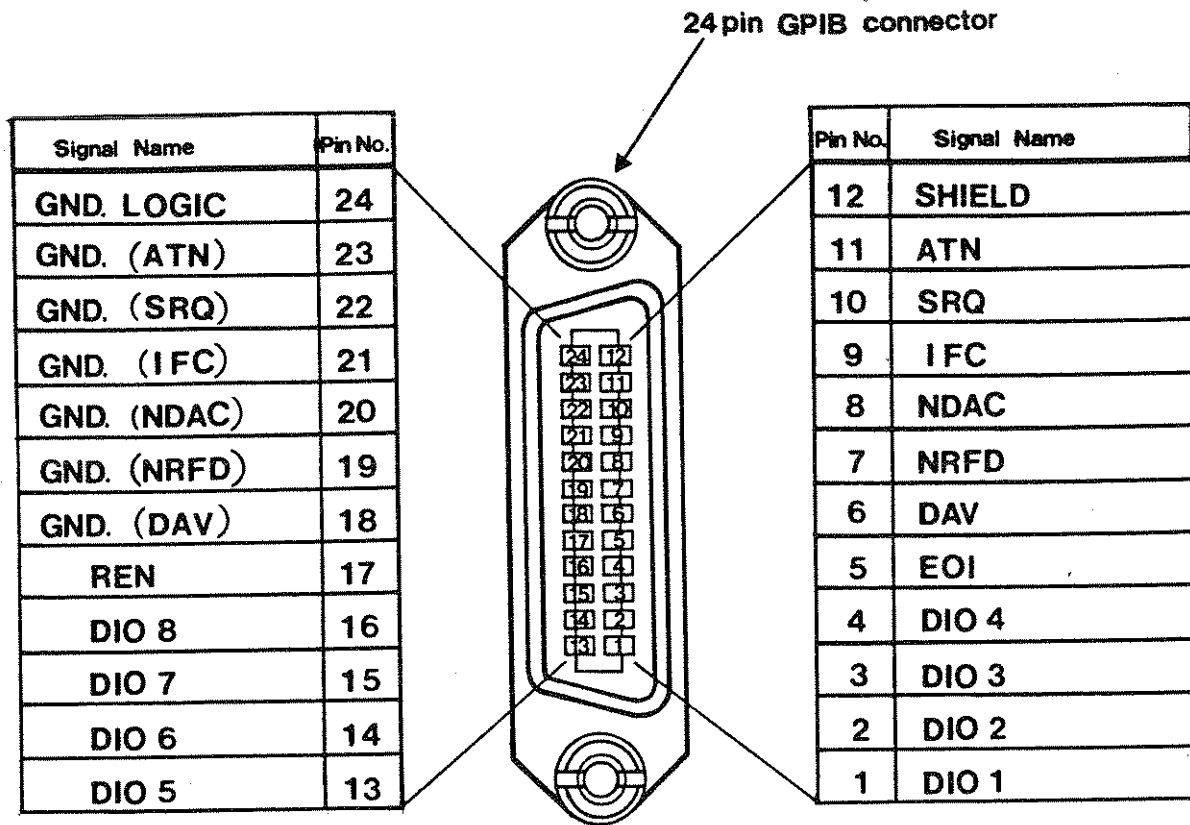

Fig. 8-3 GPIB connector pin assignments

8-3-2. Interface Functions

Table 8-1 Interface functions

Code	Function
SH1	Source handshake
AH1	Acceptor handshake
T6	Basic talker, serial poll Unaddressed to talk if addressed to listen.
L4	Basic listener function Unaddressed to listen if addressed to talk.
SR1	Service request
RL1	Remote function
PP0	No parallel poll function available.
DC1	Device clear
DT0	No device trigger function available.
C0	No controller function available.
E1	Open collector bus driver. EOI and DAV are E2 (three-state bus driver).

8-4. GPIB HANDLING OPERATION

8-4-1. Device Attachment

The GPIB system consists of multiple bus devices.

The following points should be noted:

- (1) Before making interconnections between the TR4172, controller, and peripheral devices, check the status and operation of each device.
- (2) The length of interconnecting and bus cables should be the necessary minimum. The total length of the bus cable should be 2 meters x (number of bus devices) and must not exceed 20 meters.

The following standard bus cables are available from ADVANTEST :
TR4172 spectrum analyzer complies with FCC radiation specification.
Use of the following connecting cables is suggested to construct a GPIB system with the TR4172 spectrum analyzer.

Table 8-2 Standard bus cable (Accessories available)

Length	Model Name	Stock No.
0.5 m	408JE-1P5	DCB-SS1076 x 01
1 m	408JE-101	DCB-SS1076 x 02
2 m	408JE-102	DCB-SS1076 x 03
4 m	408JE-104	DCB-SS1076 x 04

- (3) Bus cable connectors are of "piggy-back" type with both male and female plugs combined for each connector; stacked use of up to three connectors is possible.
After cable connectors are plugged to their mating receptacles, secure them with connector retention screws.
- (4) Before powering each device, carefully check their power supply conditions, grounding and necessary settings. All devices attached to the bus must be turned on. If any one of the devices is left turned off, correct system operation will not be guaranteed.

8-4-2. Setting the GPIB address

The TR4172 rear panel contains a DIP switch as shown in Figure 8-4. This switch is used to set the GPIB address of the TR4172.

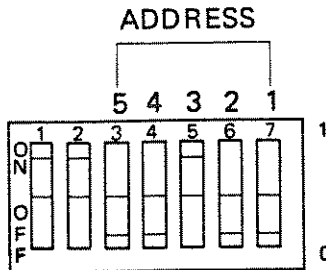

Fig. 8-4 ADDRESS switch

The GPIB address can be set by setting the bit 1-5 positions of the ADDRESS switch to 0 or 1. Table 8-4 gives the correspondence between the switch settings and addresses.

NOTE

Whenever the ADDRESS switch has been set, be sure to press the MASTER RESET key to clear the TR4172 GPIB interface temporarily.

8-5. Programming

The TR4172 allows a GPIB controller to set all its functions in remote mode. Sample programs developed with the HP Series 200 computer and TR4511 option controller are shown below.

Example : Set a center frequency of 50 MHz, a frequency span of 500 kHz, and a reference level of -10 dBm.

HP Series 200 computer

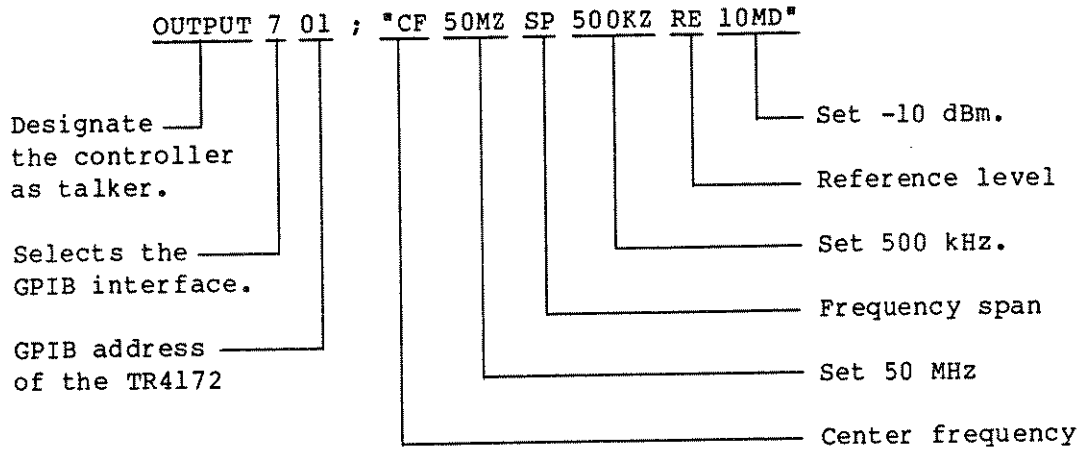

TR4511 option controller

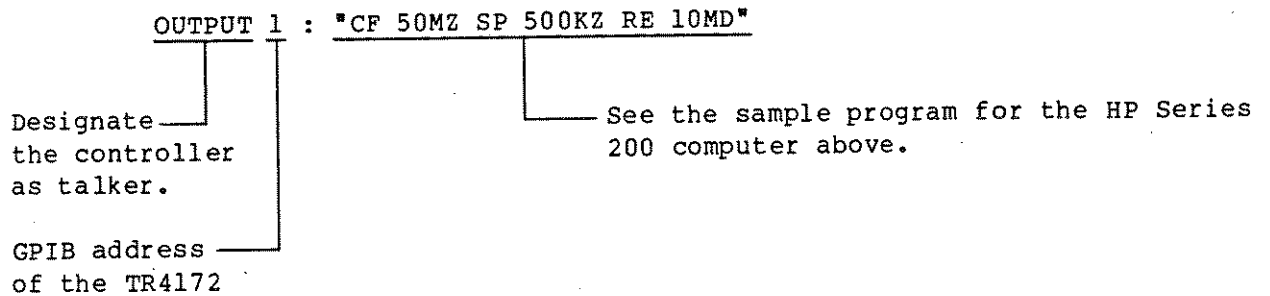

The codes, such as CF, MZ, and SP, used in the sample programs are GPIB commands associated with the TR4172 panel keys.

You can proceed with programming in the same way as you would press panel keys. Figure 8-5 shows a conceptual view of the flow of panel key operations. The first step in the flow is selecting a function, then entering data and a termination.

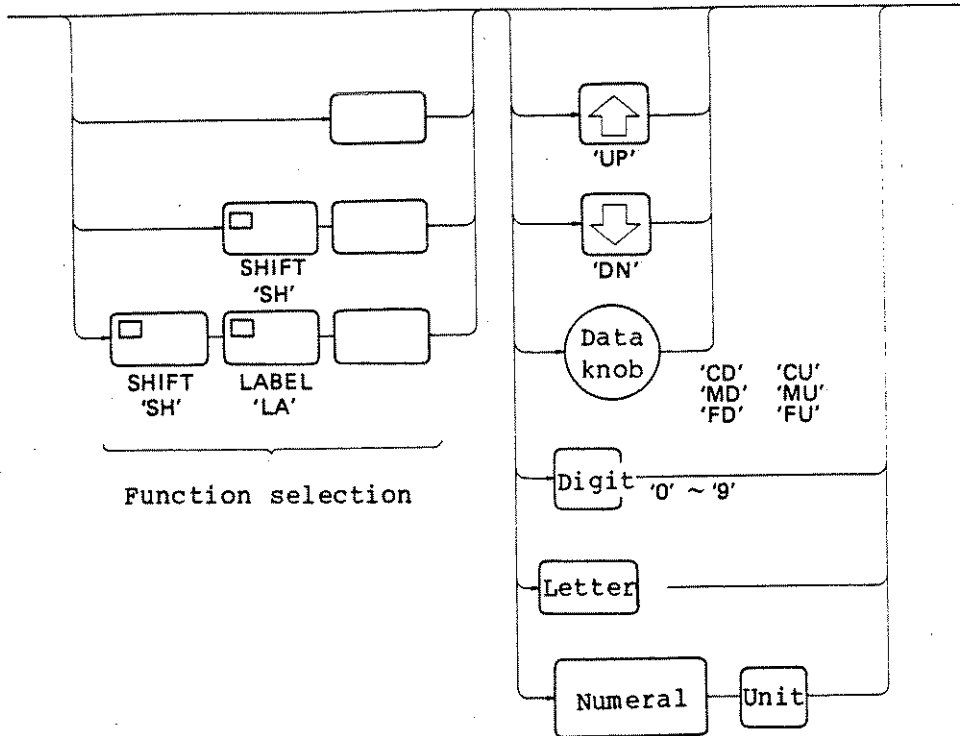

Figure 8-5 Panel key operation flow

To execute shift and double-shift key functions, enter SH and SHLA followed by the codes associated with the panel keys, respectively. The UP, DN, digit (0-9), . and letter (uppercase ASCII coded) keys can be used as data keys. To enter letters, enter the program codes associated with the panel keys. As unit keys, MZ, KZ, HZ, DB, DP, DM, SC, MS, and US are available.

Data knobs can be set both clockwise and counterclockwise in the same way as other keys. CU, MU, and PU are assigned as clockwise data knobs; CD, MD, and FD are assigned as counterclockwise data knobs. The assignment of the three data knobs in each direction permits setting three levels of data to vary (COARSE, MEDIUM, and FINE). The clockwise data knobs, CU, MU, and FU, and the counterclockwise data knobs, CD, MD, and FD, represent COARSE, MEDIUM, and FINE, respectively.

This variable data level function does not work with all of the TR4172 functions. The TR4172 functions for which data levels can be varied are: CENTER FREQ., FREQ. SPAN, START FREQ., STOP FREQ., REF LEVEL, PHASE OFFSET, GROUP DELAY OFFSET, GROUP DELAY OFFSET FINE, APERTURE, MARKER, MARKER, and DISPLAY LINE.

NOTE

Use uppercase ASCII coded letters for programming any TR4172 functions. Lowercase letters and spaces are ignored. Further, any code other than the codes defined in Table 8-5 will be ignored when received.

8-6. Data I/O

The following five basic groups of commands and their enhancements allow data to be output from the TR4172 to the GPIB interface:

OA: Outputs active data.

MF: Outputs a marker frequency.

ML: Outputs a marker level.

TO: Outputs TR4172 trace memory data in decimal.

RD: Outputs data from any TR4172 memory location.

The following two basic groups of commands and their enhancements allow data to be input from the GPIB interface to the TR4172:

LD: Inputs data to any TR4172 memory location.

TI: Inputs data to TR4172 trace memory in decimal.

Use these commands selectively to suit specific applications. Detailed instructions on how to use these commands and their formats are described below.

NOTE

While all internal memory locations in the TR4172 are accessible to the GPIB controller, inadvertent writing to spaces other than the memory spaces mentioned below is prohibited. Such writing could cause damage to the system software, because no protection is provided at all.

8-6-1. OA (Output Active Data) command

The OA command causes the TR4172 to output active numeric data when it is designated as talker. With this command, data on any function that can be set active can be output. The active state is indicated by the function name and data being distinctly displayed in the left-side part of the TR4172 screen. The active state can be set by transmitting a function set command to the TR4172 in the same way as

you press panel keys. A sample program demonstrating how to use the OA command to read a center frequency is shown below.

HP Series 200 computer

```

10: DIM A$ [24]
20: OUTPUT 701 ; "CFOA"
30: ENTER 701 ; A$
40: DISP A$
50: END

```

TR4511 option controller

```

10: DIM A$ (24)
20: OUTPUT 1 : "CFOA"
30: ENTER 1 : A$
40: DISP A$
50: END

```

Line number		Explanation
HP Series 200	TR4511	
10	10	Allocates 24 bytes of character string variable A\$.
20	20	Activates CENTER FREQ. in the TR4172. Directs the TR4172 to output active data.
30	30	Designates the TR4172 as talker to receive data from. The TR4172 outputs the CENTER FREQ. data since it has been set active.
40	40	Displays the input data (example: 3.5727E + 3 ← 3.5727 kHz).
50	50	Program end

Because the execution of the OA command yields data in numeric form, it may also be programmed in the following way:

HP Series 200 computer

```
10: OUTPUT 701 ; "CFOA"
20: ENTER 701 ; A
30: DISP A
40: END
```

TR4511 option controller

```
10: OUTPUT 1 : "CFOA"
20: ENTER 1 : A
30: DISP A
40: END
```

Line number		Explanation
HP Series 200	TR4511	
10	10	Activates CENTER FREQ. in the TR4172. Directs the TR4172 to output active data.
20	20	Designates the TR4172 as talker to receive data from. The TR4172 outputs the CENTER FREQ. data since it has been set active.
30	30	Displays the input data (example: 3572.7 ← 3.572 kHz).
40	40	Program end

When a marker is set active, the frequency and level at the marker point are displayed in the left-side part of the TR4172 screen as in:

```
MARKER
50 MHz
-10 dBm
```

With the OA command, only the frequency data on the second line above can be output. Where two sets of data are active as in this example, only the data on the upper line can be output by the OA command.

OA command output data format

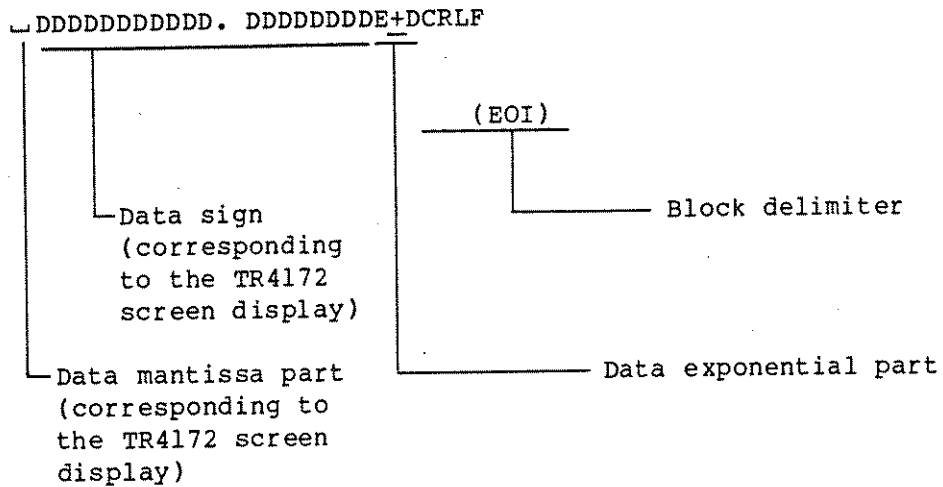

The maximum byte length of the data is 24 bytes, excluding block delimiters. The array declaration must be 24 bytes at least if data is to be read as a character string variable by using a GPIB controller or similar device. The TR4172 outputs CR and LF as a block delimiter, plus a single-line signal EOI synchronized with the LF byte.

In OA mode, the output data is converted into frequency or time data. Specifically, the output data goes through the following conversion processes:

Hz → E + 0, kHz → E + 3, MHz → E + 6
 s → E + 0, ms → E - 3
 μs → E - 6, ns → E - 9, ps → E - 12

The data sign and the data mantissa part correspond to the TR4172 screen displays. If data other than frequency and time is output with the OA command, only the data sign, data mantissa part, and block delimiter of the data are output without its unit being converted. If data cannot be decoded as numeric data (example: LIN x 1), only a block delimiter is output without numeric data.

A sample program demonstrating how to read vertical axis scale data, which is neither frequency nor time data, from the TR4172 screen is shown below.

HP Series 200 computer

```

10: DIM A$ [24]
20: OUTPUT 701 ; "SH50A"
30: ENTER 701 ; A$
40: DISP A$
50: END

```

TR4511 option controller

```

10: DIM A$ (24)
20: OUTPUT 1 : "SH50A"
30: ENTER 1 : A$
40: DISP A$
50: END

```

Line number		Explanation
HP Series 200	TR4511	
10	10	Allocates 24 bytes of character string variable A\$.
20	20	Sets the TR4172 screen vertical axis scale at 0.1 dB/, activating the scale data. Directs the TR4172 to output active data.
30	30	Designates the TR4172 as talker to receive data from. The TR4172 outputs the scale data since it has been set active.
40	40	Displays the input data (example: 0.1 ← 0.1 dB/).
50	50	Program end

Because the data to be output by the TR4172 on line 30 is a screen vertical axis scale of 0.1 dB/, which is neither frequency nor time data, only the numeric value of 0.1 is apparently output with its unit 'dB/' being ignored.

Since all data is output in numeric form in this case as well, line 30 may be reprogrammed to read as follows:

HP Series 200 computer

```
10: OUTPUT 701 ; "SH50A"  
20: ENTER 701 ; A  
30: DISP A  
40: END
```

TR4511 option controller

```
10: OUTPUT 1 : "SH50A"  
20: ENTER 1 : A  
30: DISP A  
40: END
```

Line number		Explanation
HP Series 200	TR4511	
10	10	Sets the TR4172 screen vertical axis scale at 0.1 dB/, activating the scale data. Directs the TR4172 to output active data.
20	20	Designates the TR4172 as talker to receive data from. The TR4172 outputs the scale data since it has been set active.
30	30	Displays the input data (example: 0.1 ← 0.1 dB/).
40	40	Program end

NOTE

With the OA command, whether the output data is numeric or not is determined by evaluating character codes individually. Whenever any code other than +, -, 0-9, H, k, M, s, m, μ , n, p, ., ,, /, and \square is encountered, the OA command execution terminates with a block limiter output, by abandoning further code conversion into ASCII code. The signs \square , ,, and / are ignored and are not output.

8-6-2. OALD73C4 (A) (B) command

A functional enhancement to the OA command, the OALD73C4 (A) (B) command causes the TR4172 to output any data displayed on its screen without having to activate functions. A sample program demonstrating how to use the OALD73C4 (A) (B) command to read VBW data is shown below.

HP Series 200 computer

```

10: DIM A$ [10]
20: OUTPUT 701 ; "OALD73C40800A0DD"
30: ENTER 701 ; A$
40: DISP A$
50: END

```

TR4511 option controller

```

10: DIM A$ (10)
20: OUTPUT 1 ; "OALD73C40800A0DD"
30: ENTER 1 ; A$
40: DISP A$
50: END

```

Line number		Explanation
HP Series 200	TR4511	
10	10	Allocates 10 bytes of character string variable A\$.
20	20	Directs the TR4172 to output 0008 bytes of data in the OA output format, starting at display address DDA0, as a functional enhancement to the OA command. (See Figures 8-6 and 8-7.)
30	30	Designates the TR4172 as talker to receive data from. The TR4172 outputs the specified data (VBW).
40	40	Displays the input data (example: 100E + 3 100 kHz).
50	50	Program end

Because the execution of the OALD73C4 (A) (B) command yields data in numeric form having the unit specified by the exponential part of the data, as with the OA command, it may also be reprogrammed to read as follows:

HP Series 200 computer

```

10: OUTPUT 701 ; "OALD73C40800A0DD"
20: ENTER 701 ; A
30: DISP A
40: END

```

TR4511 option controller

```

10: OUTPUT 1 : "OALD73C40800A0DD"
20: ENTER 1 : A
30: DISP A
40: END
    
```

Line number		Explanation
HP Series 200	TR4511	
10	10	Directs the TR4172 to output 0008 bytes of data, starting at display address DDA0 in the OA format, as a functional enhancement to the OA command. (See Figures 8-6 and 8-7.)
20	20	Designates the TR4172 as talker to receive data from. The TR4172 outputs the specified data (VBW).
30	30	Displays the input data (example: 100000 ← 100 kHz).
40	40	Program end

Usage of the OALD73C4 (A) (B) command and its output data format

While the data that can be output with the OA command is limited to active data displayed on the TR4172 screen, the OALD73C4 (A) (B) command allows any data displayed on the TR4172 screen to be output. First, check from Figures 8-6 and 8-7 the starting address and the byte length of the output data displayed on the TR4172 screen. In the example given above, you see that the starting address of the VBW is DDA0 in hexadecimal. Code this address in (B), low order first, high order next, as A0DD. Next, you see that the byte length is 8 bytes in hexadecimal, including spaces. Code this byte length in (A), low order first, high order next, as 0800. Thus, any data displayed on the TR4172 screen can be output by checking its starting address and byte length from Figures 8.6 and 8.7 and coding them in (A) and (B), respectively. As mentioned in the Note in the preceding section, the starting address must be a numeric data address. Although the output data format of the OALD73C4 (A)(B) command is

totally identical to that of the OA command, its maximum output byte length is limited to (A) + 2 bytes, excluding block delimiters. The array declaration must be greater than or equal to the byte length (A) + 2 bytes if data is to be read as a character string variable by using a GPIB controller or similar device. The center frequency, stop frequency, marker level counter frequency, and other data depend on settings and resolutions for their data starting address and byte length.

When reading such data with the OALD73C4 (A) (B) command, code the starting address and the byte length in the following ways:

	Starting address	Byte length
Marker (counter) frequency	DC55	26
Marker (counter) level	DC97	14

The marker (counter) frequency and marker (counter) level data can be easily read by using the MF and ML commands, respectively, as described later. The center frequency, stop frequency, etc. can be easily read by setting the relevant functions active and using the OA command.

NOTE

Because the LD73C4 (A) (B) command is recognized as a command sequence having a block length of 14 bytes, only valid data should be included in it.

```
OUTPUT 701; "OA"
OUTPUT 701; "LD73C4 (A) (B)"
```

While 'OA' and "LD73C4 (A) (B)" can be separated by a block delimiter as above, "LD73C4 (A) (B)" itself cannot be separated by a block delimiter as shown below.

```
OUTPUT 701; "LD73C4"
OUTPUT 701; "(A) (B)"
```

While those of you having experience with the TR4171, TR4172, TR4170, etc. may have used the command "OALD73C5 _____" this command is not supported by the TR4172. Be sure to change it to the "OALD73C4 _____" command.

In transmitting the LD73C4 (A) (B) to the TR4172, use either CR and LF, plus a single-line signal EOI synchronized with the LF byte, or CR alone as a block delimiter.

8-6-3. MF (Marker Frequency Output) command

The MF command causes the TR4172 to output marker frequency data when it is designated as talker. A sample program demonstrating how to use the MF command to read a marker frequency is shown below.

HP Series 200 computer

```
10: DIM A$ [26]
20: OUTPUT 701 ; "MKMF"
30: ENTER 701 ; A$
40: DISP A$
50: END
```

TR4511 option controller

```
10: DIM A$ (26)
20: OUTPUT 1 : "MKMF"
30: ENTER 1 : A$
40: DISP A$
50: END
```

Line number		Explanation
HP Series 200	TR4511	
10	10	Allocates 26 bytes of character string variable A\$.
20	20	Turns on the TR4172 marker for output.
30	30	Designates the TR4172 as talker to receive data from.
40	40	Displays the input data (example: MKR_____437.2895916 MHz).
50	50	Program end

Because the execution of the MF command yields character string data, a character string variable must be used if data is to be read by using a GPIB controller or similar device.

MF command output data formats

Marker mode

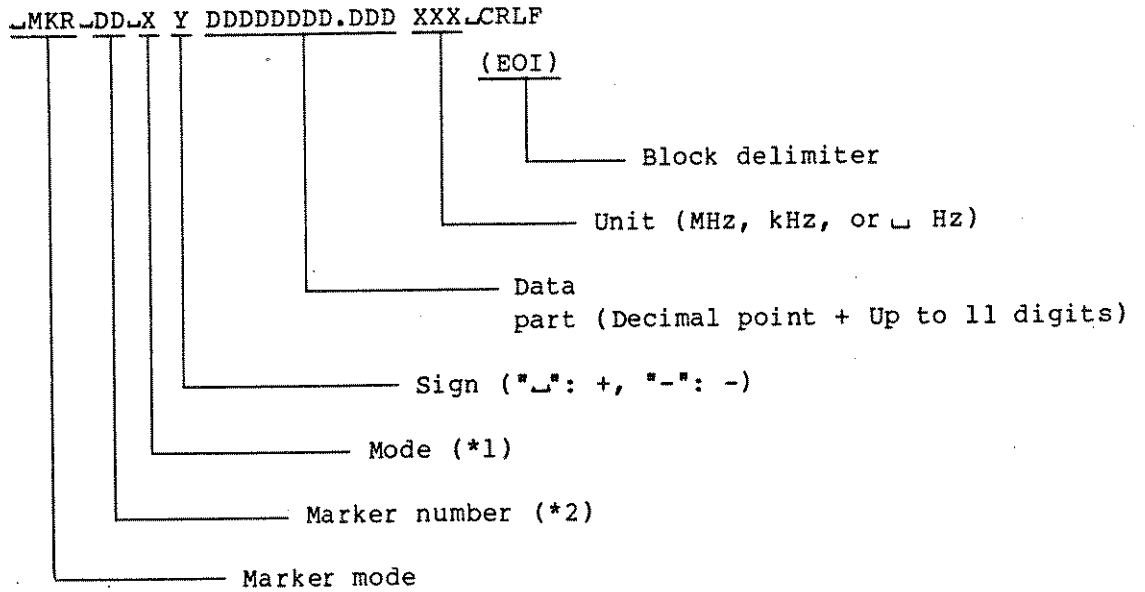

Counter mode

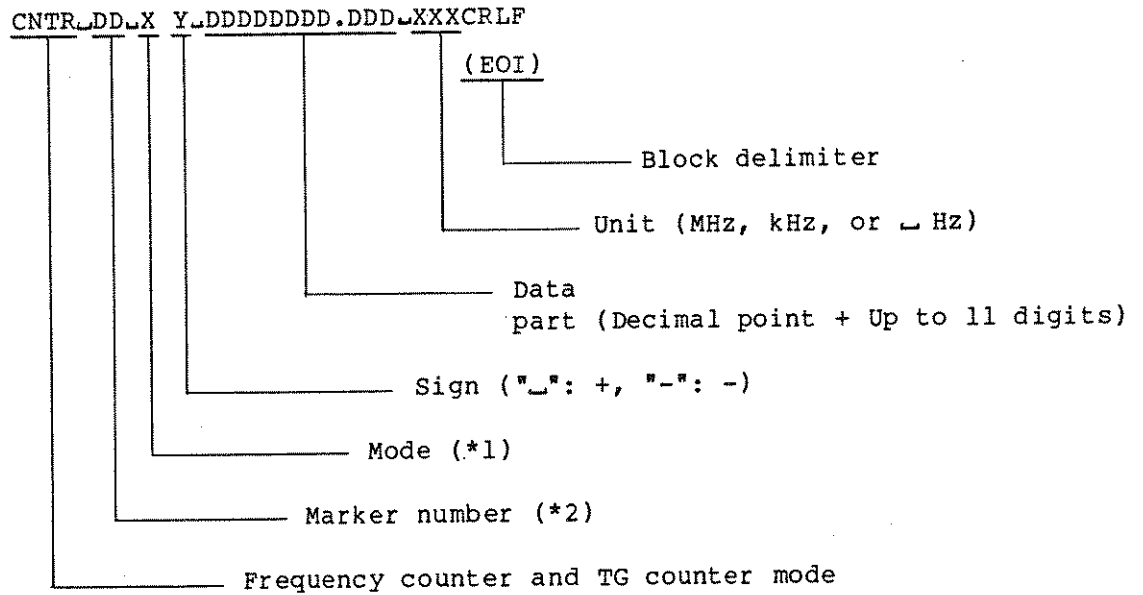

*1 Mode

d: Delta mode
z: Zoom mode
_: Other marker mode

*2 Marker number

Multimarker mode: _1 to 10
Single-marker mode: __

Because the output data in the data formats in the marker and counter modes shown above is fixed at 26 bytes, the array declaration of the character string variable must be 26 bytes at least. The position of the decimal point in the data part and its data length correspond to the TR4172 screen displays. If the data part is 10 digits or shorter, the data for (11 - number of significant digits) is shifted to the beginning (before MKR or CNTR) for output. In the MF mode, the TR4172 outputs CR and LF as a block delimiter, plus a single-line signal EOI synchronized with the LF byte.

If frequency data output is specified with the MF command in a mode other than marker or counter, only space codes and block delimiters are output. If frequency counting is in progress, MRK and CNTR headers, space codes, and block delimiters are output; data is simply output as space codes.

The following TR4172-specific characters that are not in the ASCII codes are converted into the following ASCII codes for output:

$\Omega \rightarrow _$, $\Delta \rightarrow d$, $\text{~} \rightarrow \text{~}$, $o \rightarrow *$, $\mu \rightarrow u$

With the MF command, data cannot be output in modes other than delta, zoom, and multimarker. Detailed instructions on how to read frequencies in the counter mode and read data in various marker modes can be found in "Sample programming."

8-6-4. MFLD73C4 (A) (B) command

A functional enhancement to the MF command, the "MFLD73C4 (A) (B)" command causes the TR4172 to output any characters displayed on its screen. A sample program demonstrating how to use the "MFLD73C4 (A) (B)" command to read marker level data is shown below.

HP Series 200 computer

```

10: DIM A$ [14]
20: OUTPUT 701 ; "MFLD73C40E0099DC"
30: ENTER 701 ; A$
40: DISP A$
50: END

```

TR4511 option controller

```

10: DIM A$ (14)
20: OUTPUT 1 : "MFLD73C40E0099DC"
30: ENTER 1 : A$
40: DISP A$
50: END

```

Line number		Explanation
HP Series 200	TR4511	
10	10	Allocates 14 bytes of character string variable A\$.
20	20	Directs the TR4172 to output 000E bytes of data, starting at display address DC99, as a functional enhancement to the MF command (marker level). (See Figures 8-6 and 8-7.)
30	30	Designates the TR4172 as talker to receive data from. The TR4172 outputs the specified data (marker level).
40	40	Displays the input data (example: -19.7 dBm).
50	50	Program end

Because the execution of the "MFLD73C4 (A) (B)" command character string data as with the MF command, a character string variable must be used if data is to be read by using a GPIB controller or similar device.

Usage of the "MFLD73C4 (A) (B)" command and its output data format

While data that can be output with the MF command is limited to marker frequencies, the "MFLD73C4 (A) (B)" command allows any characters displayed on the TR4172 screen to be output.

First, check from Figures 8-6 and 8-7 the starting address and the byte length of the output data displayed on the TR4172 screen. In the example given above, the starting address of the marker level is DC99 in hexadecimal. Code this address in (B), low order first, high order next, as 99DC. Next, the byte length is 0E bytes in hexadecimal, including spaces. Code this byte length in (A), low order first, high order next, as 0E00. Thus, any data displayed on the TR4172 screen can be output by checking its starting address and byte length from Figures 8-6 and 8-7 and coding them in (A) and (B), respectively.

The following TR4172-specific characters that are not in the ASCII codes are converted into the following ASCII codes for output:

$\Omega \rightarrow \square$, $\Delta \rightarrow d$, $" \rightarrow "$, $o \rightarrow *$, $\mu \rightarrow u$

Because space codes are output as they are, the array declaration must be greater than or equal to the byte length specified by (A) if data is to be read by using a GPIB controller or similar device.

NOTE

Because the "LD73C4 (A) (B)" command is recognized as a command sequence having a block length of 14 bytes, only valid data should be included in it.

```
OUTPUT 701; "MF"  
OUTPUT 701; "LD73C4 (A) (B)"
```

While "MF" and "LD73C4 (A) (B)" can be separated by a block delimiter as above, "LD73C4 (A) (B)" itself cannot be separated by a block delimiter as shown below.

```
OUTPUT 701; "LD73C4"  
OUTPUT 701; "(A) (B)"
```

While those of you having experience with the TR4171, TR4172, TR4170, etc. may have used the command "MFLD73C5 _____", this command is not supported by the TR4172. Be sure to change it to the "MFLD73C4 _____" command.

In transmitting the "LD73C4 (A) (B)" to the TR4172, use either CR and LF, plus a single-line signal EOI synchronized with the LF byte, or CR alone as a block delimiter.

8-6-5. ML (Marker Level Output) command

The ML command causes the TR4172 to output marker level data when it is designated as talker. A sample program demonstrating how to use the ML command to read a marker level is shown below.

```
HP Series 200 computer  
10: OUTPUT 701 ; "ML"  
20: ENTER 701 ; A  
30: DISP A  
40: END
```

TR4511 option controller

```
10: OUTPUT 1 : "ML"  
20: ENTER 1 : A  
30: DISP A  
40: END
```

Line number		Explanation
HP Series 200	TR4511	
10	10	Directs the TR4172 to output marker level data.
20	20	Designates the TR4172 as talker to receive data from.
30	30	Displays the input data (example: -19.7 ← -19.7 dBm).
40	40	Program end

Execution of the ML command yields numeric data without having to use a character string variable when data is read by using a GPIB controller or similar device.

ML command output data format

Data is output in the same format as it would be output by the OA command. The maximum output byte length is limited to 14 bytes, excluding block delimiters.

8-6-6. "MLLD73C4 (A) (B)" command

A functional enhancement to the ML command, the "MLLD73C4 (A) (B)" command causes the TR4172 to output any data displayed on its screen in an equivalent of the ML output format. A sample program demonstrating how to use the "MLLD73C4 (A) (B)" command to read sweep time data is shown below.

HP Series 200 computer

```
10: OUTPUT 701 ; "MLLD73C40700F3DD"  
20: ENTER 701 ; A  
30: DISP A  
40: END
```

TR4511 option controller

```

10: OUTPUT 1 : "MLLD73C40700F3DD"
20: ENTER 1 : A
30: DISP A
40: END

```

Line number		Explanation
HP Series 200	TR4511	
10	10	Directs the TR4172 to output 0007 bytes of data, starting at display address DDF3, as a functional enhancement to the ML command (sweep time). (See Figures 8-6 and 8-7.)
20	20	Designates the TR4172 as talker to receive data from. The TR4172 outputs the specified data (sweep time).
30	30	Displays the input data (example: 0.190 ← 190 ms).
40	40	Program end

Input data may also be read as a character string variable as with the OA command as explained below.

HP Series 200 computer

```

10: DIM A$ [9]
20: OUTPUT 701 ; "MLLD73C40700F3DD"
30: ENTER 701 ; A$
40: DISP A$
50: END

```

TR4511 option controller

```

10: DIM A$ (9)
20: OUTPUT 1 : "MLLD73C40700F3DD"
30: ENTER 1 : A$
40: DISP A$
50: END

```

Line number		Explanation
HP Series 200	TR4511	
10	10	Allocates 9 bytes of character string variable A\$. 9 bytes are allocated because the output length is the specified number of bytes + 2 as described in 8-6-2.
20	20	7. Directs the TR4172 to output 0007 bytes of data, starting at display address DDF3, as a functional enhancement to the ML command (sweep time). (See Figures 8-6 and 8-7.)
30	30	Designates the TR4172 as talker to receive data from. The TR4172 outputs the specified data (sweep time).
40	40	Displays the input data (example: 190E-3 -- 190 ms).
50	50	Program end

Usage of the "MLLD73C4 (A) (B)" command and its output data format

While data that can be output with the ML command is limited to marker levels, the "MLLD73C4 (A) (B)" command allows any data displayed on the TR4172 screen to be output in an equivalent of the ML output format.

First, check from Figures 8-6 and 8-7 the starting address and the byte length of the output data displayed on the TR4172 screen. In the example given above, the starting address of the sweep time is DDF3 in hexadecimal. Code this address in (B), low order first, high order next, as F3DD. Next, the byte length is 7 bytes in hexadecimal, including spaces. Code this byte length in (A), low order first, high order next, as 0700. Thus, any data displayed on the TR4172 screen can be output by checking its starting address and byte length from Figures 8-6 and 8-7 and coding them in (A) and (B), respectively.

Although the output data format of the "MLLD73C4 (A) (B)" command is totally identical to that of the OA command, its maximum output byte length is limited to (A) + 2 bytes, excluding block delimiters.

In practice, because the "MLLD73C4 (A) (B)" command is internally decoded and executed as a procedure totally identical to the "OALD73C4 (A) (B)" command described earlier, either command may be used at your discretion.

NOTE

Because the "LD73C4 (A) (B)" command is recognized as a command sequence having a block length of 14 bytes, only valid data should be included in it.

```
OUTPUT 701; "ML"  
OUTPUT 701; LD73C4 (A) (B)"
```

While "ML" and "LD73C4 (A) (B)" can be separated by a block delimiter as above, "LD73C4 (A) (B)" itself cannot be separated by a block delimiter as shown below.

```
OUTPUT 701; "LD73C4"  
OUTPUT 701; "(A) (B)"
```

While those of you having experience with the TR4171, TR4172, TR4170, etc. may have used the command "MLLD73C5____", this command is not supported by the TR4172. Be sure to change it to the "MLLD73C4____" command.

In transmitting the "LD73C4 (A) (B)" to the TR4172, use either CR and LF, plus a single-line signal EOI synchronized with the LF byte, or CR alone as a block delimiter.

8-6-7. TO (Trace Data Decimal Output) command

The TO command causes the TR4172 to output, in decimal, waveform trace memory (A) and (B) data displayed on its screen (data 0 to 1,023 without having a unit in the vertical axis direction) when it is designated as talker. For the trace memory configuration, see Section 8-6-8, "RD command". A sample program demonstrating how to use the TO command is shown below.

HP Series 200 computer

```
10: OUTPUT 701 ; "RDC0180040"  
20: OUTPUT 701 ; "TO"  
30: ENTER 701 ; A  
40: ENTER 701 ; B  
50: DISP A  
60: DISP B  
70: END
```

TR4511 option controller

```
10: OUTPUT 1 : "RDC0180040"  
20: OUTPUT 1 : "TO"  
30: ENTER 1 : A  
40: ENTER 1 : B  
50: DISP A  
60: DISP B  
70: END
```

Line number		Explanation
HP Series 200	TR4511	
10	10	Directs the TR4172 to access waveform trace memory data in sequence, starting at address C018.
20	20	Directs the TR4172 to output data in decimal, starting at the address specified above.
30	30	Designates the TR4172 as talker to receive data from. The TR4172 converts data from addresses C018 and C019 into decimal for output.
40	40	Designates the TR4172 as talker to receive data from. The TR4172 converts data from addresses C01A and C01B into decimal for output.
50	50	Displays the input data A.
60	60	Displays the input data B.
70	70	Program end

Execution of the TO command thus outputs trace data (0 to 1,023, without a vertical axis unit) point after point.

NOTE

Although waveform trace memory on the TR4172 screen is organized into 12 bits per point, only the lower 10 bits are valid as data. If waveform data appears to overflow the screen due to an incorrect reference level setting, data in excess of 1,023 may be read when the TO command is executed. In this case, correct the reference level setting and retry.

Usage of the TO command and its output data format

Code the starting address of trace memory from which data is to be output in (A) in TO (A) 0040 in hexadecimal, high order first, low order next. See in Section 8-6-8. for an explanation of trace memory addresses.

Because 0040 is a constant, it must be precisely coded as 0040.

Transmit this RD (A) 0040 command, separated by block delimiters into blocks of 10 bytes each, before transmitting the TO command.

When the TR4172 is designated as talker after the RD (A) 0040 command is transmitted to it, it outputs 12-bit binary data in decimal, starting at the address (A).

Output data is output in four digits, beginning with the most significant digit, as DDDDCRLF (EOI). If the data is short of four digits, the vacant digits are filled with 0s.

There is no need to specify the output byte length. If the TR4172 is designated as talker, the output data address is automatically incremented by 2 bytes at a time, thereby allowing the data from the next point in trace memory to be output.

The TO command may also be used to output data from a source other than trace memory in decimal. If any address is specified in (A), the data at that address is automatically converted into decimal for output. Though the output format is the same, the most significant digit is always 0 because 8-bit binary data is converted into decimal. Likewise, address incrementation is automatic if the TR4172 is designated as talker, in which case the output data address is incremented by 1 byte at a time.

NOTE

When using the TO command to specify decimal output by the TR4172, separate "RD (A) 0040" and TO with a block delimiter as shown below.

```
OUTPUT 701; "RD (A) 0040"  
OUTPUT 701; "TO"
```

Because the "RD (A) 0040" command is recognized as a command sequence having a block length of 10 bytes, only valid data should be included in it.

"RD (A) 0040" itself cannot be separated by a block delimiter as shown below.

```
OUTPUT 701; "RD (A)"  
OUTPUT 701; "0040"
```

In transmitting the "RD (A) 0040" command to the TR4172, use either CR and LF, plus a single-line signal EOI synchronized with the LF byte, or CR alone as a block delimiter.

8-6-8. RD (Read Memory) command

The RD command causes the TR4172 to output, in hexadecimal, any memory data displayed within itself when it is designated as talker. A sample program demonstrating how to use the RD command to read waveform trace memory data is shown below.

HP Series 200 computer

```

10: DIM A$ [8]
20: OUTPUT 701 ; "RDC01800004"
30: ENTER 701 ; A$
40: DISP A$
50: END

```

TR4511 option controller

```

10: DIM A$ (8)
20: OUTPUT 1 : "RDC01800004"
30: ENTER 1 : A$
40: DISP A$
50: END

```

Line number		Explanation
HP Series 200	TR4511	
10	10	Allocates 8 bytes of character string variable A\$.
20	20	Directs the TR4172 to output 4 bytes of trace memory A data (4 bytes within the TR4172 = two trace points) in hexadecimal, starting at address C018.
30	30	Designates the TR4172 as talker to receive data from.
40	40	Displays the input data. Example: 3AF139F1 <div style="margin-left: 100px;"> Data at address C019 Data at address C018 </div>
50	50	Program end

Waveform trace memory on the TR4172 screen is organized into 12 bits per point, only the lower 10 bits are valid as data. The lower 8 bits of data are stored in the lower even-numbered addresses in memory, with the upper 4 bits of data in the upper odd-numbered addresses.

Trace memory A and trace memory B are independently assigned memory addresses for the 1,001 points on the horizontal axis as explained below.

(1) Tracing one screen in trace memory A and B each

Trace A	Address: <u>C018, C019,</u> , <u>C7E8, C7E9</u> Leftmost point 1 in the screen Rightmost point 1,001 in the screen	1,001 points
Trace B	Address: <u>C818, C819,</u> , <u>CFE8, CFE9</u> Leftmost point 1 in the screen Rightmost point 1,001 in the screen	1,001 points

(2) Tracing two screens in trace memory A and B each

Trace A	C018, C019, C01C, C01D,, C7E8, C7E9	501 points
Trace A'	C01A, C01B, C01E, C01F,, C7E6, C7E7	500 points
Trace B	C818, C819, C81C, C81D,, C8E8, C8E9	501 points
Trace B'	C81A, C81B, C81E, C81F,, C8E6, C8E7	500 points

To read trace memory B data, for example, replace C018 on line 10 in the sample program above with C818.

For two-screen display (A and A') in trace memory A, trace memory A data is input to numeric variable A on line 30 in the sample program and trace memory B data is input to numeric variable B on line 40. Subsequently, trace memory A and A' data is alternately input point by point likewise.

Usage of the RD command and its output data format

Code the starting address of trace memory from which data is to be output in (A) in "RD (A) (B)" and the output byte length (byte length within the TR4172, not the actual output byte length) in (B), both in hexadecimal, high order first, low order next.

Because the "RD (A) (B)" command is recognized as a command sequence having a block length of 10 bytes, only valid data should be included in it.

"RD (A) (B)" itself cannot be separated by a block delimiter as shown below.

OUTPUT 701; "RD"

OUTPUT 701; "(A) (B)"

In transmitting the "RD (A) (B)" command to the TR4172, use either CR and LF, plus a single-line signal EOI synchronized with the LF byte, or CR alone as a block delimiter.

Output data is output as $D_1D_2D_3D_4D_5D_6\dots$ CRLF (EOI). In this format, D_1 denotes the upper digit of the data (hexadecimal) stored at the starting address converted into ASCII code in its hexadecimal format. D_2 denotes the lower digit of the same data converted into ASCII code. D_3 denotes the upper digit of the data (hexadecimal) stored at the next address converted into ASCII code in its hexadecimal format, and so on.

Because the actual output byte length is two times the byte length specified by (B) due to hexadecimal to ASCII conversion excluding block delimiters, the array declaration must be greater than or equal to the byte length (B) multiplied by 2 if data is to be read as a character string variable by using a GPIB controller or similar device.

When trace memory data is output with the RD command, the data corresponding to the upper digit of each odd-numbered address in trace memory is always F, though it should be ignored because it is invalid data. During execution of trace arithmetic functions (such as $A - B \rightarrow A$, NORMALIZE), it may happen that the data corresponding to the upper digit of an odd-numbered address in trace memory exceeds 3. This is because sign bits are included in the positions upper than the lower 10 bits. These bits (bits 11 and 12) should be

ignored. As previously mentioned in connection with the TO command, if waveform data exceeds 03FF (1,023 in decimal), it means an incorrect reference level setting. In this case, correct the reference level setting and retry.

8-6-9. Binary Data Output (Functional enhancement to the RD command)

As a functional enhancement to the RD command, trace memory data can be output in binary, in which case each point of trace data is output in 2 bytes, high order first, low order next. A sample program is shown below.

HP Series 200 computer

```
10: DIM A (2001)
20: DIM Dat (1000)
30: OUTPUT 701 ; "RDC01803E9"
40: OUTPUT 701 ; "LDBEB501"
50: ENTER 701 USING "%, B" ; A(*)
60: J = 0
70: FOR I = 0 TO 2001 STEP 2
80: Dat (J) = A (I) * 256 + A (I+1)
90: J = J+1
100: NEXT I
110: END
```

TR4511 option controller

```
10: DIM A (2001)
20: DIM Dat (1000)
30: OUTPUT 1 ; "RDC01803E9"
40: OUTPUT 1 ; "LDBEB501"
50: ENTER 1 USING "%, B" ; A(*)
60: J = 0
70: FOR I = 0 TO 2001 STEP 2
80: Dat (J) = A (I) * 256 + A (I+1)
90: J = J+1
100: NEXT I
110: END
```

NOTE

Execution of the RD command clears the current active function of the TR4172.

Line number		Explanation
HP Series 200	TR4511	
10	10	Allocates 2,002 bytes of numeric variable A.
20	20	Allocates 1,001 bytes of numeric variable Dat.
30	30	Directs the TR4172 to output 1,001 points of trace memory A data, starting at address C018.
40	40	Directs the TR4172 to output trace memory data in binary, starting at the address specified above.
50	50	Designates the TR4172 as talker to receive data from.
60	60	Resets the index J.
70	70	FOR loop in which the value of I is incremented from 0 to 2,000 by 2 at a time.
80	80	Converts the output data (2 bytes per point) into one byte per point and store it in Dat.
90	90	Increments the index J to 1.
100	100	Runs the FOR loop of the loop counter I.
110	110	Program end

8-6-10. LD (Load Memory) command

The LD command is used to write data to any memory location in the TR4172. If this command is used, TR4172 measurement data can be read with other data output commands and subjected to arithmetic manipulations by the GPIB controller, then rewritten into the TR4172 screen for display. It also permits writing the upper and lower levels of measurement. A sample program demonstrating how to use the LD command is shown below.

HP Series 200 computer

```
10: OUTPUT 701 ; "BVSHAV"
20: OUTPUT 701 ; "LDC90023FAB31C"
30: END
```

TR4511 option controller

```
10: OUTPUT 1 ; "BVSHAV"
20: OUTPUT 1 ; "LDC90023FAB31C"
30: END
```

Line number		Explanation
HP Series 200	TR4511	
10	10	Sets TR4172 trace memory to B VIEW, A BLANK.
20	20	Writes 23, FA, B3, and 1C in hexadecimal to TR4172 internal memory, starting at address C900.
30	30	Program end

Execution of this LD command writes 23 to address C900, FA to address C901, B3 to address C902, and 1C to address C903, all in hexadecimal.

Usage of the LD command

Code the write starting address in (A) in "LD (A) (B)" in hexadecimal, high order first, low address next, and the data to write in (B) in hexadecimal in sequence.

Because the "LD (A) (B)" command is recognized as a command sequence having a block length of 10 bytes, only valid data should be included in it.

The (A)(B) command cannot be separated by a block delimiter as shown below.

```
OUTPUT 701 ; "LD"  
OUTPUT 701 ; (A) (B)
```

In transmitting the "LD (A) (B)" command to the TR4172, use either CR and LF, plus a single-line signal EOI synchronized with the LF byte, or CR alone as a block delimiter.

8-6-11. TI (Trace Data Input) command

The TI command is used to write data 0 to 1,023 to waveform trace memory in the TR4172. A sample program demonstrating how to use the TI command is shown below.

HP Series 200 computer

```
10: OUTPUT 701 ; "AVRDC180040"  
20: OUTPUT 701 ; "TI"  
30: FOR A=1 TO 1001  
40: OUTPUT 701 ; A  
50: NEXT A  
60: END
```

TR4511 option controller

```
10: OUTPUT 1 : "AVRDC180040"  
20: OUTPUT 1 : "TI"  
30: FOR A=1 TO 1001  
40: OUTPUT 1 : A  
50: NEXT A  
60: END
```

Line number		Explanation
HP Series 200	TR4511	
10	10	Sets TR4172 trace memory to A VIEW. Directs the TR4172 to access waveform trace memory data in sequence, starting at address C018.
20	20	Directs the TR4172 to output data in decimal, starting at the address specified above.
30	30	Assigns a sequentially incremented value to variable A, starting at the initial value of 1.
40	40	Writes data A to TR4172 trace memory A.
50	50	Returns to line 30 unless the value of variable A exceeds 1,001.
60	60	Program end

Be sure to hold data to write to trace memory to 0 to 1,000 in decimal. Though data can be written up to 1,023, it would overflow the TR4172 screen if written. Note that, if writing of data above 1,204 is attempted, it may be truncated when converted internally.

Usage of the TI command

OUTPUT 701; "RD (A) 0040"

OUTPUT 701; "TI"

Code the write starting address in (A) in "RD (A) 0040" in hexadecimal, high order first, low order next. Because 0040 is a constant, it must be precisely coded as '0040'. Transmit this "RD (A) 0040" command, separated by block delimiters into blocks of 10 bytes each, before transmitting the TI command.

As the TR4172 is set in the decimal data input mode after the "RD (A) 0040" command and the TI command are transmitted to it, enter one point of decimal data next. Data can be written sequentially without having to specify the write byte length; provided, however, that the

data must be entered point by point and separated by block delimiters (CR and LF, plus a single-line signal EOI synchronized with the LF byte, or CR alone). Each time data is written to TR4172 trace memory, the write address is automatically incremented by one point of trace memory (2 bytes).

Data cannot be entered without a decimal point. If input data contains a decimal point, the data below the decimal point is ignored. This mode is automatically canceled when the input data cannot be recognized as a decimal number.

NOTE

Execution of the TI command clears the current active function of the TR4172.

8-7. Label Entry

When a label is entered, the first optional character that follows the label entry program code LA is recognized as a terminator. Enter the character string to be displayed as a label in the label area in the top of the screen, separated by terminator characters. A sample program using an HP85 and a TR4511 option controller is shown below.

[Example 3]: Write A B C D as a label. (Use "?" as a terminator.)

HP85

```
10  OUTPUT 701 ; "LA ? ABCD?"  
20  END
```

TR4511 option controller

```
10  OUTPUT 1 : "LA ? ABCD?"  
20  END
```

Line number	Explanation
10	Displays the character string "ABCD" in the label area.
20	Program end

8-8. Learn Mode

The TR4172 keeps save registers 1 to 8 open to the user. Additions can be made to the TR4172's save registers in a virtual manner by using the GPIB controller memory.

First, set the TR4172 into the desired save state by using TR4172 panel keys or the GPIB controller. Next, save this status in the TR4172's save register 0, and read the status information stored in save register 0 into the GPIB controller memory.

In this way, additions can be made to the TR4172's save registers by using its save register 0 as a buffer. Next, write the TR4172 status information saved in the GPIB controller memory to the TR4172's save register 0 and execute recall 0, and the TR4172 status information saved in the GPIB controller memory can be recalled.

A sample program is shown below.

HP Series 200 computer

```
10: DIM A$ [94]
20: OUTPUT 701 ; "SHINO"
30: OUTPUT 701 ; "RD7400002E"
40: ENTER 701 ; A$
}
100: OUTPUT 701 ; "LD7400" ; A$
110: OUTPUT 701 ; "SHLIO"
```

TR4511 option controller

```
10: DIM A$ (94)
20: OUTPUT 1 : "SHINO"
30: OUTPUT 1 : "RD7400002E"
40: ENTER 1 : A$
}
100: OUTPUT 1 : "LD7400" ; A$
110: OUTPUT 1 : "SHLIO"
```

Line number		Explanation
HP Series 200	TR4511	
10	10	Allocates 94 bytes of character string variable A\$.
20	20	Saves the current TR4172 setting in save register 0.
30	30	Directs the TR4172 to output 2EH bytes of data from save register 0 in hexadecimal, starting at address 7400.
40	40	Designates the TR4172 as talker to receive data from.
}	}	
100	100	Writes the data stored in character string variable A\$ (save register 0), starting at TR4172 address 7400.
110	110	Sets the TR4172 in recall 0.

As the starting address of save register 0, the address 7400 must be precisely coded as such. Because each TR4172 save register is made up of 2EH bytes, the array declaration in the character string variable must be greater than or equal to $2EH + 1 = 94$ bytes if the register data is to be output in hexadecimal.

8-9. Block Delimiters

When the TR4172 is designated as talker to output ASCII data, The TR4172 outputs a 2-byte code of CR and LF as a block delimiter, plus a single-line signal EOI synchronized with the LF byte. When the TR4172 outputs binary data, it outputs a single-line signal EOI synchronized with the last byte of the data.

When program codes or data are input to the TR4172 from a GPIB controller or similar device, it operates with one of the following block delimiters:

- (1) A 2-byte code of CR and LF, plus a single-line signal EOI synchronized with the LF byte.
- (2) A 1-byte code of LF.
- (3) A single-line signal EOI synchronized with the last byte of data.
- (4) A 2-byte code of CR and LF.

Note, however, that the aforementioned data I/O commands - OA, MF, ML, TO, RD, LD, and TI - operate only on specified delimiters. For how to specify these block delimiters, refer to the descriptions of the relevant commands.

8-10. Data Transfer Rates

Sample programs that measure the data transfer rates of decimal output, hexadecimal image output, and binary output are shown below, along with the measurement data. (Each of these sample programs measures the rate at which 1,001 points of data are transferred from trace memory A.) These programs are intended only for reference purposes. Because the internal system software operates on interrupt handling principles, the data transfer rates indicated below may not be established under certain setup conditions.

HP Series 200 computer

1) Decimal output

```
10: DIM D(1000)
20: J=TIMEDATE
30: OUTPUT 701 ; "RDC01807D2"
40: OUTPUT 701 ; "TO"
50: FIR I=0 TO 1000
60: ENTER 701 ; D(I)
70: NEXT I
80: PRINT TIMEDATE-J
90: END
```

2) Hexadecimal image output

```
10: DIM H$ [4003]
20: J=TIMEDATE
30: OUTPUT 701 ; "RDC01807D2"
40: ENTER 701 ; H$
50: PRINT TIMEDATE-J
60: END
```

3) Binary output

```

10: DIM B(2001)
20: J=TIMEDATE
30: OUTPUT 701 ; "RDC01803E9"
40: OUTPUT 701 ; "LDBEB501"
50: ENTER 701 USING "%,B" ; B(*)
60: PRINT TIMEDATE-J
70: END
    
```

Data transfer ratesh

Output mode	Trigger mode	
	FREE RUN	SINGLE
Decimal output	2.58	2.50
Hexadecimal image output	0.27	0.26
Binary output	1.80	1.79

Unit: s

8-11. Service Requests

Using the GPIB service request facility enables the GPIB controller to detect the following conditions of the TR4172:

- (1) The TR4172 has completed a screen trace up to the rightmost end of the screen.
 - (2) The TR4172 has completed a preset number of times of averaging.
- The serial poll status byte indicates these conditions. Table 8-3 analyzes the configuration of the status byte.

Table 8-3 Status byte format

BIT #	7	6	5	4	3	2	1	0
Decimal value	128	64	32	16	8	4	2	1
Function		SERVICE REQUEST (SRQ)			AVERAGE END	TRACE END		

Bit 2: Set to 1 when the TR4172 has completed a screen trace up to the rightmost end of the screen. This bit is 0 while a trace is in progress.

Bit 3: Set to 1 when the TR4172 has completed a preset number of times of averaging. This bit is 0 until the preset number of times of averaging is reached. (With averaging on, bit 2 is set from 0 to 1 at the same time that bit 3 is set to 1.)

The service request can be turned on and off by using the GPIB program codes SQ and SR.

SQ: Enables service request transmission.

SR: Disables service request transmission.

If a service request condition arises after the SQ mode has been set, the TR4172 halts its screen trace and issues a service request to the GPIB controller. The GPIB controller can direct the TR4172 to output data for arithmetic processing. To resume the screen trace to obtain measurement data after various processing has been completed and necessary changes have been made to the TR4172 status, transmit the DR (status byte reset & trace start) command. This command restarts the TR4172 screen trace. Since the TR4172 is still in the SQ mode, it will halt its screen trace again if another service request condition occurs.

To exit from the SQ mode and return to the SR mode (disables service request transmission) and thus restore the TR4172 trace status to normal, transmit the SR command, then the DR command.

If the SR mode is changed to the SQ mode after various changes have been made to the TR4172 panel status, invalid TR4172 screen trace data could result. To prevent this, execute a dummy serial poll to the TR4172 immediately after the SQ mode is set, then transmit the DR command to retrace the display data.

To obtain screen trace measurement data after various changes have been made to the TR4172 panel status in the SQ mode, also transmit the DR command to retrace the display data. These procedures are flowcharted below.

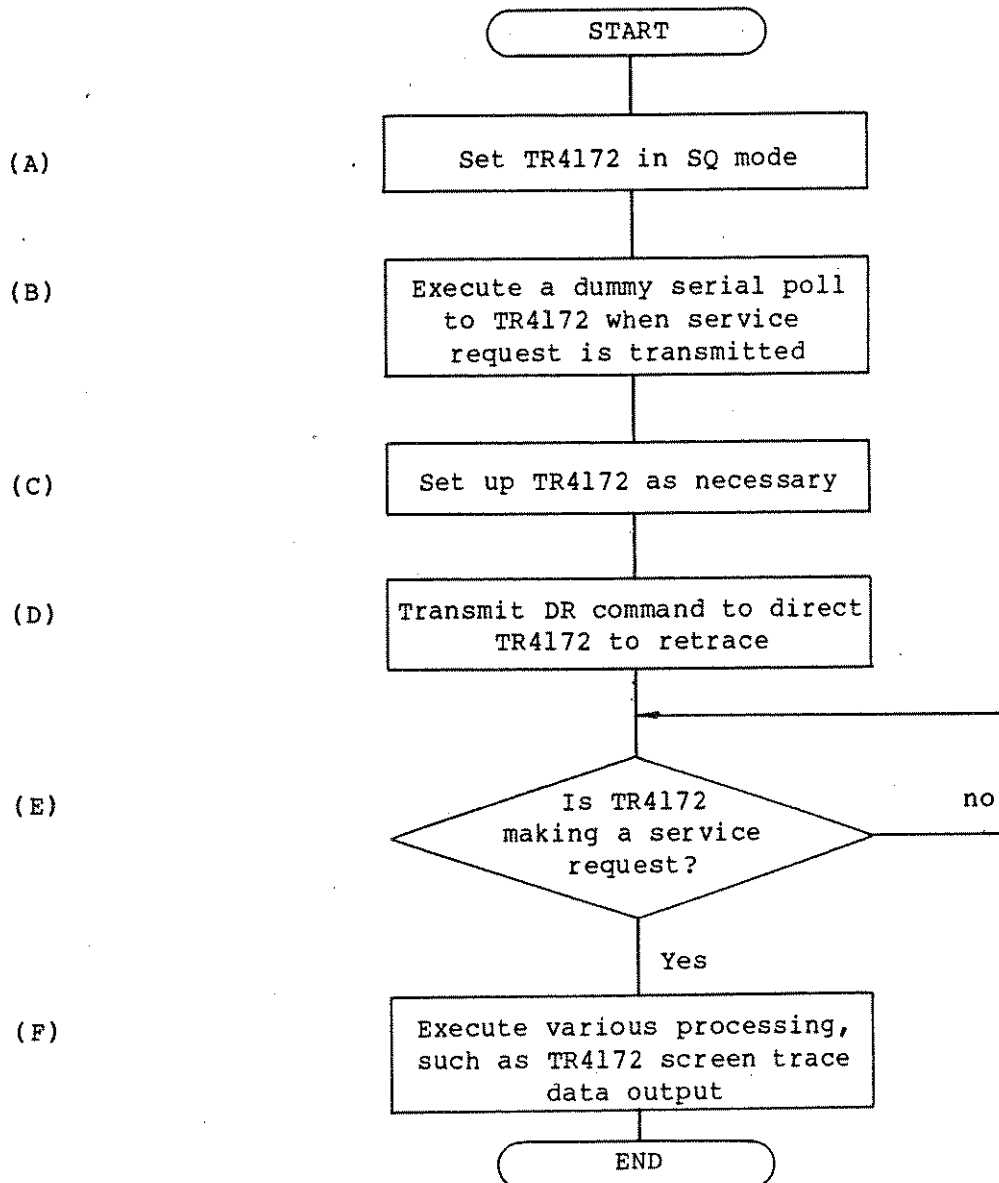

Note: Because a hardware sweep and a software trace in the TR4172 occur totally independently, it may happen that trace memory does not provide a correct trace of the setup status throughout a screen under certain setup conditions in (F). To prevent this, execute processes (D) and (E) in succession ((D) → (E) → (D) → (E)).

For averaging, turn on averaging (C), in which case (D) need not be executed. If (D) is executed, SRQ would not be output.

A sample program demonstrating how to use a service request to determine the peak level of an input signal around 1 MHz is shown below.

HP Series 200 computer

```
10: OUTPUT 701 ; "SQ"  
20: ON INTR 7 GOTO 50  
30: ENABLE INTR 7 ; 2  
40: GOTO 30  
50: S=SPOLL(701)  
60: OUTPUT 701 ; "CF 1MZ SP 50KZ RE 10DM"  
70: GOSUB 120  
80: OUTPUT 701 ; "MK PS ML"  
90: ENTER 701 ; A  
100: DISP A  
110: STOP  
120: OUTPUT 701 ; "DR"  
130: ON INTR 7 GOTO 160  
140: ENABLE INTR 7 ; 2  
150: GOTO 140  
160: S=SPOLL(701)  
170: IF S=68 THEN 190  
180: GOTO 120  
190: RETURN  
200: END
```

TR4511 option controller

```
10: OUTPUT 1 : "SQ"  
20: ON SRQ GOTO 50  
30: ENABLE INTR  
40: GOTO 30  
50: S=SPOLL(1)  
60: OUTPUT 1 : "CF 1MZ SP 50KZ RE 10DM"  
70: GOSUB 120  
80: OUTPUT 1 : "MK PS ML"  
90: ENTER 1 : A  
100: DISP A  
110: END  
120: OUTPUT 1 : "DR"  
130: ON SRQ GOTO 160  
140: ENABLE INTR  
150: GOTO 140
```

```

160: S=SPOLL(1)
170: IF S=68 THEN 190
180: GOTO 120
190: RETURN

```

Line number		Explanation
HP Series 200	TR4511	
10	10	Sets the TR4172 in the SRQ mode.
20	20	Directs the controller to jump to line 50 when a GPIB SRQ interrupt occurs.
30	30	Sets the controller in the mode enabling the GPIB SRQ interrupts.
40	40	Directs the controller to loop without doing anything until a GPIB SRQ interrupt occurs.
50	50	Directs the controller to execute a serial poll to the TR4172 when a GPIB SRQ interrupt occurs. (Lines 20 to 60 contain procedures for a single run of dummy processing of the service request immediately following the setting of the TR4172 in the SQ mode.)
60	60	Sets the TR4172 at a center frequency of 1 MHz, a frequency span of 50 kHz, and a reference level of -10 dBm.
70	70	Calls a subroutine from line 120.
80	80	Turns on the TR4172 marker to effect a peak search for peak level output.
90	90	Designates the TR4172 as talker to receive data from.
100	100	Displays the input data.
110	110	Program halt
120	120	Resets the TR4172 status byte to resume the trace.
130	130	Directs the controller to jump to line 160 when a GPIB SRQ interrupt occurs.
140	140	Sets the controller in the mode enabling the GPIB SRQ interrupts.
150	150	Directs the controller to loop without doing anything until a GPIB SRQ interrupt occurs.

Line number		Explanation
HP Series 200	TR4511	
160	160	Directs the controller to execute a serial poll to the TR4172 and receive the status byte when a GPIB SRQ interrupt occurs.
170	170	Directs the controller to jump to line 190 if the TR4172 status is trace end.
180	180	If the TR4172 status is not trace end, directs the TR4172 to retrace, with the controller looping until the next GPIB SRQ interrupt occurs.
190	190	Returns from the subroutine (to line 80).
200	200	Program end

Next, a sample program demonstrating how to use a service request in the TR4172 SINGLE TRIGGER mode is shown below. In the SINGLE TRIGGER mode, the DR command must be preceded with the SHSW (sweep reset) command.

HP Series 200 computer

```

10: OUTPUT 701 ; "IP SW 2SC"
20: OUTPUT 701 ; "SQ"
30: ON INTR 7 GOTO 60
40: ENABLE INTR 7 ; 2
50: GOTO 40
60: S=SPOLL(701)
70: OUTPUT 701 ; = "SI MK"
80: GOSUB 120
90: OUTPUT 701 ; "ML"
100: ENTER 701 ; A
110: DISP A
120: STOP
130: OUTPUT 701 ; "SHSW"
135: OUTPUT 701 ; "DR"
140: ON INTR 7 GOTO 160
150: ENABLE INTR 7 ; 2
160: GOTO 140

```

```

170: S=SPOLL(701)
180: IF S=68 THEN 190
190: GOTO 135
200: RETURN
210: END

```

TR4511 option controller

```

10: OUTPUT 1 : "IP SW 2SC"
20: OUTPUT 1 : "SQ"
30: ON SRQ GOTO 60
40: ENABLE INTR
50: GOTO 40
60: S=SPOLL(1)
70: OUTPUT 1 : "SI MK ML"
80: GOSUB 120
90: OUTPUT 1 : "ML"
100: ENTER 1 : A
110: DISP A
120: END
130: OUTPUT 1 : "SHSW"
135: OUTPUT 1 : "DR"
140: ON SRQ GOTO 160
150: ENABLE INTR
160: GOTO 140
170: S=SPOLL(1)
180: IF S=68 THEN 190
190: GOTO 135
200: RETURN

```

Line number		Explanation
HP Series 200	TR4511	
10	10	Sets a 2-second sweep time after setting the TR4172 in the instrumental preset state.
20	20	Sets the TR4172 in the SQ mode.
30	30	Directs the controller to jump to line 60 when a GPIB SRQ interrupt occurs.

Line number		Explanation
HP Series 200	TR4511	
40	40	Sets the controller in the mode enabling the GPIB SRQ interrupts.
50	50	Directs the controller to loop without doing anything until a GPIB SRQ interrupt occurs.
60	60	Directs the controller to execute a serial poll to the TR4172 when a GPIB SRQ interrupt occurs. (Lines 30 to 60 contain procedures for a single run of dummy processing of the service request immediately following the setting of the TR4172 in the SRQ mode.)
70	70	Sets the TR4172 in the SINGLE TRIGGER mode and turns on the marker.
80	80	Calls a subroutine from line 120.
90	90	Directs the TR4172 to output marker level data when it is designated as talker.
100	100	Designates the TR4172 as talker to receive data from. (The TR4172 outputs the marker level.)
110	110	Displays the input data.
120	120	Program halt
130	130	Transmits the SHSW command to the TR4172 and resets the status byte.
135	135	Resumes the trace.
140	140	Directs the controller to jump to line 160 when a GPIB SRQ interrupt occurs.
150	150	ets the controller in the mode enabling the GPIB SRQ interrupts.
160	160	Directs the controller to loop without doing anything until a GPIB SRQ interrupt occurs.
170	170	Directs the controller to execute a serial poll to the TR4172 and receive the status byte when a GPIB SRQ interrupt occurs.
180	180	Directs the controller to jump to line 190 if the TR4172 status is trace end.

Line number		Explanation
HP Series 200	TR4511	
190	190	If the TR4172 status is not trace end, directs the TR4172 to retrace, with the controller looping until the next GPIB SRQ interrupt occurs.
200	200	Returns from the subroutine (to line 90).
210		Program end

NOTE

To exit from the SQ mode and return to the SR mode (disables service request transmission) and thus restore the TR4172 trace status to normal, transmit the SR command, then the DR command.

If the DR command is not transmitted, the SR mode is set but the trace will remain halted without returning to normal status.

Trace memory may not provide a correct trace of the TR4172 setup status immediately after its function settings (such as CENTER FREQ. and REF. LEVEL) have been altered, immediately after the SQ mode has been set, and when a service request has been received. In this case, transmit the DR command to direct TR4172 to execute a retrace, or alternatively, transmit the SQ command to override the initial service request, then complete various status changes as necessary before transmitting the DR command for a retrace.

8-12. Direct Plotting Using the GPIB Controller

Because the built-in direct plot software in the TR4172 lets the TR4172 function as a GPIB controller by itself, certain care should be exercised when another GPIB controller is used to execute direct plotting. A sample program demonstrating the use of another GPIB controller is shown below.

HP Series 200 computer

```
10: OUTPUT 701 ; "SQ"  
20: OUTPUT 701 ; "CF50MZSP1MZ"  
30: GOSUB 130  
40: OUTPUT 701 ; "DR"  
50: GOSUB 180  
60: OUTPUT 701 ; "LD783D00"  
70: OUTPUT 701 ; "SHLA221"  
80: SEND 7 ; UNL TALK 1 LISTEN 5 DATA  
90: GOSUB 210  
100: DISP "PLOT END"  
110: OUTPUT 701 ; "SRDR"  
120: STOP  
130: ON INTR 7 GOTO 160  
140: ENABLE INTR 7 ; 2  
150: GOTO 140  
160: S=SPOLL(701)  
170: RETURN  
175: OUTPUT 701 ; "DR"  
180: GOSUB 130  
190: IF S<>68 THEN 175  
200: RETURN  
205: OUTPUT 701 ; "DR"  
210: GOSUB 130  
220: IF BIT(S,4) THEN 240  
230: GOTO 205  
240: RETURN  
250: END
```

TR4511 option controller

```
10: OUTPUT 1 : "SQ"  
20: OUTPUT 1 : "CF50MZSP1MZ"  
30: GOSUB 130  
40: OUTPUT 1 : "DR"  
50: GOSUB 180  
60: OUTPUT 1 : "LD783D00"  
70: OUTPUT 1 : "SHLA221"  
80: SEND UNL TALK 1 LISTEN 5 DATA
```



```

90: GOSUB 210
100: DISP "PLOT END"
110: OUTPUT 1 : "SRDR"
120: END
130: ON SRQ GOTO 160
140: ENABLE INTR
150: GOTO 140
160: S=SPOLL(1)
170: RETURN
175: OUTPUT 1 : "DR"
180: GOSUB 130
190: IF S<>68 THEN 180
200: RETURN
205: OUTPUT 1 : "DR"
210: GOSUB 130
220: IF BIT(S,4) THEN 240
230: GOTO 205
240: RETURN

```

If using the standard TR9831 or TR9834R, substitute "PL" for "SHLA2" on line 70. Proceed to enter values as required by the subsequent key operations.

Line number		Explanation
HP Series 200	TR4511	
10	10	Sets the TR4172 in the SQ mode.
20	20	Sets the TR4172 at a center frequency of 50 MHz and a frequency span of 1 MHz.
30	30	Calls a subroutine from line 130 (for dummy processing of the service request immediately following the setting of the TR4172 in the SQ mode.)
40	40	Resets the TR4172 status byte to resume the trace.
50	50	Calls a subroutine from line 180 (to wait for the end of the TR4172 trace).
60	60	Resets the TR4172 GPIB serial poll register.

Line number		Explanation
HP Series 200	TR4511	
70	70	SHLA2: Loads the option 07 PLOT program. 2: Selects 7470. 1: Selects ALL.
80	80	Cancels all listeners and designates the TR4172 as talker. Designates the plotter as listener. Sets ATN to HI.
90	90	Calls a subroutine from line 210.
100	100	Issues the message "PLOT END."
110	110	Sets the TR4172 in the SRQ mode, and resets its status byte to resume the trace.
120	120	Program halt
130	130	Directs the controller to jump to line 160 when a GPIB SRQ interrupt occurs.
140	140	Sets the controller in the mode enabling the GPIB SRQ interrupts.
150	150	Directs the controller to loop without doing anything until a GPIB SRQ interrupt occurs.
160	160	Directs the controller to execute a serial poll to the TR4172 when a GPIB SRQ interrupt occurs.
170	170	Returns from the subroutine.
175	175	Retrace.
180	180	Calls the subroutine from line 130.
190	190	If the TR4172 status is not trace end, directs the TR4172 to retrace, with the controller looping until the next GPIB SRQ interrupt occurs.
200	200	Returns from the subroutine.
205	205	Retrace.
210	210	Calls the subroutine from line 130.

Line number		Explanation
HP Series 200	TR4511	
220	220	Directs the controller to jump to line 240 if the TR4172 status is plot end.
230	230	If the TR4172 status is not plot end, directs the TR4172 to retrace, with the controller looping until the next GPIB SRQ interrupt occurs.
240	240	Returns from the subroutine.
250	250	Program end

Line 60 is mandatory. If line 60 is not executed, the TR4172 plot end status would not be set. Consequently, control could not return from the subroutine call on line 90.

8-13. Programming Notes

GPIB programming for the TR4172 is essentially accomplished by coding procedures in the same way as you press panel keys, though certain points require special attention.

8-13-1. Counter programming

Just like panel operations, transmitting the counter program codes CN and FC, or SHFC and SHCN once turns on the counter; transmitting these codes once again turns the counter off.

Because the counter is turned off whenever the counter program codes CN and FC, or SHFC and SHCN are transmitted while the marker is off, it is recommended that you turn on the marker after once turning it off, then turn on the counter to ensure operational accuracy.

The TR4172 service request facility does not have counter end status. When the counter is used, set a wait time according to the available counter resolution. The wait time can be generally calculated by:

$$(\text{Wait time}) \geq (\text{Counter gate time}) + (\text{Sweep time}) \times 2$$

8-13-2. Phase mode programming

(1) Phase scale setting

Transmit the codes listed below to directly set numeric data for the phase scale. Only "HZ" can be used as a termination.

Phase Scale	GPIB code
80°/div	0HZ, 1HZ
40°/div	2HZ, 3HZ
20°/div	4HZ, 5HZ
8°/div	6HZ
4°/div	7HZ
2°/div	8HZ
0.8°/div	9HZ
0.4°/div	10HZ
0.2°/div	11HZ

(2) Phase offset setting

Notice that the only termination that can be used in setting numeric data is "HZ."

8-13-3. Group delay mode programming

(1) Group delay scale setting

Numeric data for the group delay scale cannot be set directly. Rather, use either the data knob or step key GPIB code. The current scale data can be read by using the OA command in conjunction.

(2) Group delay offset (fine) setting

Notice that the only termination that can be used in setting numeric data is "HZ".

8-14. GPIB Usage Notes

8-14-1. MASTER RESET key

Similar in function to the POWER switch, the MASTER RESET key is operable regardless of the GPIB interface status. Pressing the MASTER RESET key clears the TR4172 GPIB interface temporarily.

8-14-2. DEVICE CLEAR (DCL and SDC) and IP commands

Both the DEVICE CLEAR (DCL and SDC) and IP commands initialize the settings of the TR4172. The device is reset to an equivalent to the status that would be established on a power-on reset and by pressing the MASTER RESET key.

8-14-3. GROUP EXECUTE TRIGGER

Because the TR4172 GPIB interface facility does not support the group execute trigger, this message is ignored if it is received.

"T" is displayed in the active area on the screen at this time.

8-14-4. INTERFACE CLEAR and ATN

If the TR4172 GPIB interface receives INTERFACE CLEAR or ATN=TRUE while it is handshaking with data as a talker or listener, it handles INTERFACE CLEAR or ATN=TRUE on a priority basis. Consequently, the data then in the middle of handshaking may be ignored.

8-14-5. TALKER

If a high (= false) on both NRFD and NDAC is detected while the TR4172 is handshaking on the GPIB interface as a talker, the handshaking procedure is forced to a termination.

8-14-6. SERVICE REQUEST

The SRQ on and off modes are not cleared by the DEVICE CLEAR and IP commands.

Table 8-4 Address code table

ASCII coded character		ADDRESS switch					5-bit decimal code
LISTEN	TALK	A5	A4	A3	A2	A1	
SP	e	0	0	0	0	0	0
!	A	0	0	0	0	1	1
*	B	0	0	0	1	0	2
#	C	0	0	0	1	1	3
\$	D	0	0	1	0	0	4
%	E	0	0	1	0	1	5
&	F	0	0	1	1	0	6
'	G	0	0	1	1	1	7
(H	0	1	0	0	0	8
)	I	0	1	0	0	1	9
*	J	0	1	0	1	0	10
+	K	0	1	0	1	1	11
,	L	0	1	1	0	0	12
-	M	0	1	1	0	1	13
.	N	0	1	1	1	0	14
/	O	0	1	1	1	1	15
0	P	1	0	0	0	0	16
1	Q	1	0	0	0	1	17
2	R	1	0	0	1	0	18
3	S	1	0	0	1	1	19
4	T	1	0	1	0	0	20
5	U	1	0	1	0	1	21
6	V	1	0	1	1	0	22
7	W	1	0	1	1	1	23
8	X	1	1	0	0	0	24
9	Y	1	1	0	0	1	25
:	Z	1	1	0	1	0	26
;	[1	1	0	1	1	27
<	\	1	1	1	0	0	28
=]	1	1	1	0	1	29
>	~	1	1	1	1	0	30

Table 8-5 Programming Codes

Item	Code	Description	Initially selected
DATA	0 to 9	0 to 9	
	.	.	
	MZ	MHz	
	KZ	kHz	
	HZ	Hz	
	DP	+dBm	
	DM	-dBm	
	DB	dB	
	SC	sec	
	MS	msec	
	US	µsec	
	UP	↑	
	DN	↓	
	CU	COARSE UP (Data knob, clockwise)	
	MU	MIDIUM UP (Data knob, clockwise)	
	FU	FINE UP (Data knob, clockwise)	
	CD	COARSE DOWN (Data knob, counterclockwise)	
	MD	MIDIUM DOWN (Data knob, counterclockwise)	
FD	FINE DOWN (Data knob, counterclockwise)		
BS	BACK SPACE		
Measurement mode	NO	NORMAL	o
	TG	TG ON	
	PG	PHASE	
	GD	GROUP DELAY	

Table 8-5 Programming Codes (cont'd)

Item	Code	Description	Initially selected
FUNCTION	CF	CENTER FREQ.	
	SP	FREQ. SPAN	
	RE	REF. LEVEL	
	SW	SWEEP TIME	
	AS	SWEEP TIME AUTO	o
	RB	RES. B. W.	
	BA	RES. B. W. AUTO	o
	VB	VIDEO B. W.	
	VA	VIDEO B. W. AUTO	o
	CS	FREQ. STEP SIZE	
	CA	FREQ. STEP SIZE AUTO	o
SCALE	PY	PHASE SCALE	
	GY	GROUP DELAY SCALE	
I/O	AT	INPUT ATT	
	TA	INPUT ATT AUTO	o
	TL	TG LEVEL	
	PR	INPUT-2	
	DC	INPUT-1 DC	
	AC	INPUT-1 AC	o
TRIGGER	IN	FREE RUN	o
	LI	LINE	
	EX	EXT	
	VT	VIDEO	
	SI	SINGLE	

Table 8-5 Programming Codes (cont'd)

Item	Code	Description	Initially selected
TRACE	AW	A WRITE	○
	AV	A VIEW	
	AZ	A' VIEW	
	BW	B WRITE	
	BV	B VIEW	
	BZ	B'VIEW	
	BB	B → B'	
	CH	A ↔ B	
	AB	A-B → A ON	
	BD	B-DL → B	
SAVE & RECALL	SA	SAVE	
	RC	RECALL	
MARKER	MK	MARKER	○
	MO	MARKER OFF	
	MT	Δ	
	PS	PEAK SEARCH	
	MC	MKR → CF	
	MR	MKR → REF	
	MP	MKR/Δ → STEP SIZE	
	SG	SIGNAL TRACK	
	ZO, OO	ZOOM	
	CN, FC	COUNTER	
Others	DL	DISPLAY LINE	○
	LA	LABEL	
	PL	PLOT	
	HO	DATA HOLD	
	LC	LOCAL	
	SH	SHIFT	
	IP	INSTRUMENTAL PRESET(0 to 2 GHz)	

Table 8-5 Programming Codes (cont'd)

Item	Code	Description	Initially selected
DATA	SQ	Service Request Enable	
IN/OUT	SR	Service Request Disable	
	DR	Status byte Reset & Trace start	
	MF	MARKER FREQ OUTPUT	
	ML	MARKER LEVEL OUTPUT	
	OA	OUTPUT ACTIVE DATA	
	LD	LOAD MEMORY	
	RD	READ MEMORY	
	TO	TRACE DATA DECIMAL OUTPUT	
	TI	TRACE DATA DECIMAL INPUT	

The functions marked by a circle (o) are automatically set when the power is turned on, when the MASTER RESET key is pressed, when the IP command is received, or when the Device Clear message is received. To execute shift and double-shift key functions, enter SH and SHLA followed by the codes associated with the panel keys, respectively.

Table 8-6 TR4172 alphanumeric character set vs. hex codes

	Normal	Large	End
P	00	40	80
A	01	41	81
B	02	42	82
C	03	43	83
D	04	44	84
E	05	45	85
F	06	46	86
G	07	47	87
H	08	48	88
I	09	49	89
J	0A	4A	8A
K	0B	4B	8B
L	0C	4C	8C
M	0D	4D	8D
N	0E	4E	8E
O	0F	4F	8F
P	10	50	90
Q	11	51	91
R	12	52	92
S	13	53	93
T	14	54	94
U	15	55	95
V	16	56	96
W	17	57	97
X	18	58	98
Y	19	59	99
Z	1A	5A	9A
—	1B	5B	9B
Ω	1C	5C	9C
k	1D	5D	9D
Δ	1E	5E	9E
m	1F	5F	9F

	Normal	Large	End
blank	20	60	A0
n	21	61	A1
'	22	62	A2
#	23	63	A3
j	24	64	A4
&	25	65	A5
z	26	66	A6
o	27	67	A7
d	28	68	A8
μ	29	69	A9
*	2A	6A	AA
+	2B	6B	AB
,	2C	6C	AC
-	2D	6D	AD
.	2E	6E	AE
/	2F	6F	AF
0	30	70	B0
1	31	71	B1
2	32	72	B2
3	33	73	B3
4	34	74	B4
5	35	75	B5
6	36	76	B6
7	37	77	B7
8	38	78	B8
9	39	79	B9
:	3A	7A	BA
s	3B	7B	BB
<	3C	7C	BC
=	3D	7D	BD
>	3E	7E	BE
?	3F	7F	BF

8-15. CONNECTION TO PLOTTER (TR9834R)

This section describes attachment of TR9834R Plotter to the TR4172 Analyzer.

First, connect the GPIB connector on the rear of the TR4172 to that on the TR9834R with the supplied GPIB cable. Then set the TR9834R to the LISTEN ONLY mode and power it up.

After setting up all measurement conditions on the TR4172, press

Q. If the frequency axis is in the logarithmic scaling (see Section 4-14-8), however, press only Q key. The

display will show the following message:

```
'1' TR9831
    '2' TR9834R
    '0' QUIT
```

Press the Data key 2. The message displayed on the screen will change as shown below. If a TR9831 is connected to the TR4172, press the key 1. Pressing the key 0 returns the TR4172 to the status it was in

before the Q switch was depressed.

```
PLOT     Q
      SHIFT LABEL Δ
      '1' LARGE
      '2' SMALL
      '0' QUIT
```

Press the Data key 1 (LARGE) to plot display data (waveforms, graticules, characters, markers, and labels) in A3 size, the key 2 (SMALL) to plot it in A4 size (size of this instruction manual).

Pressing the key 0 will return the TR4172 to the status it was in

before the Q switch was depressed. Where only character text, such as HELP messages, is displayed, plotting starts immediately. On a normal screen display, the following message appears after the LARGE/SMALL select switch is pressed.



PLOT

'1' ALL

'2' TRACE

'0' QUIT

Press the Data key 1 (ALL) to plot all display data, and the key 2 (TRACE) to plot waveforms only. The key 2 can be used to overlay a new waveform over previously plotted data.

Pressing the key 0 (QUIT) will return the TR4172 to the status it was in before the    switch was depressed.

After the ALL/TRASE select switch is pressed, the characters that had been displayed in the active area prior to the display of the above message are displayed again and plotting begins.

Pressing the key 0 during plotting cancels the plotting operation causing the initial PLOT message to be displayed.

After plotting, a single-page feed occurs unless only a waveform has been plotted. When a waveform is to be overlaid over previously plotted data, only the waveform should be plotted first.

The TR9834R Plotter can be operated in either one pen or two pen mode. Text information, graticule, and contents of memories A and A' are plotted by pen 1, while the contents of memories B and B' are plotted by pen 2. The contents of blanked memory will not be plotted, however. In the BOTH display mode, images A and B may be plotted in different colors if different color pens are used for pens 1 and 2.

When the TR9834R Plotter is attached to the TR4172 Analyzer, the TR4172 functions as a controller for the TR9834R. Therefore, no other devices or controller should, in principle, be attached to the TR4172.

When in the single display mode, signal response trace and graticule may be plotted in different colors if trace information is stored in memory B.

When using two pens, calibrate their relative positions by referring to the TR9834R Instruction Manual.

The recording paper for the TR9834R is available in roll and leaf papers. When leaf paper is to be used, the pen(s) may not automatically return to its (their) home position upon completion of plotting, with the REMOTE and PROMPT lamps flashing. If this occurs, press the position switches on the TR9834R to return the pen to its home position.

8-16. CONNECTION TO PLOTTER (TR9831)

Connection and operating procedures are the same as those of TR9834R. However, power the instrument on while the TR9831 FEED switch is being pressed.

The TR9831 allows the selective use of four pens, pens 1, 2, 3 and 4. Among the TR4172 display data, characters and graticules are plotted with pen 1 and the contents of traces A, B, A' and B' are plotted with pens 1, 2, 3 and 4 respectively. Blank traces are not plotted. (See Table 8-5.)

The following message is displayed when plotting with the TR9831 is disabled:

(ERROR) PLOTTER DOWN OR CONNECTOR DRAWN OUT

'1' CONTINUE

'0' QUIT

Table 8-5 Display data and pen correspondence

TR4172 display data	TR9831	TR9834R
Trace A	Pen 1	Pen 1
Trace B	Pen 2	Pen 2
Trace A'	Pen 3	Pen 1
Trace B'	Pen 4	Pen 2
Graticules	Pen 1	Pen 1
Characters	Pen 1	Pen 1

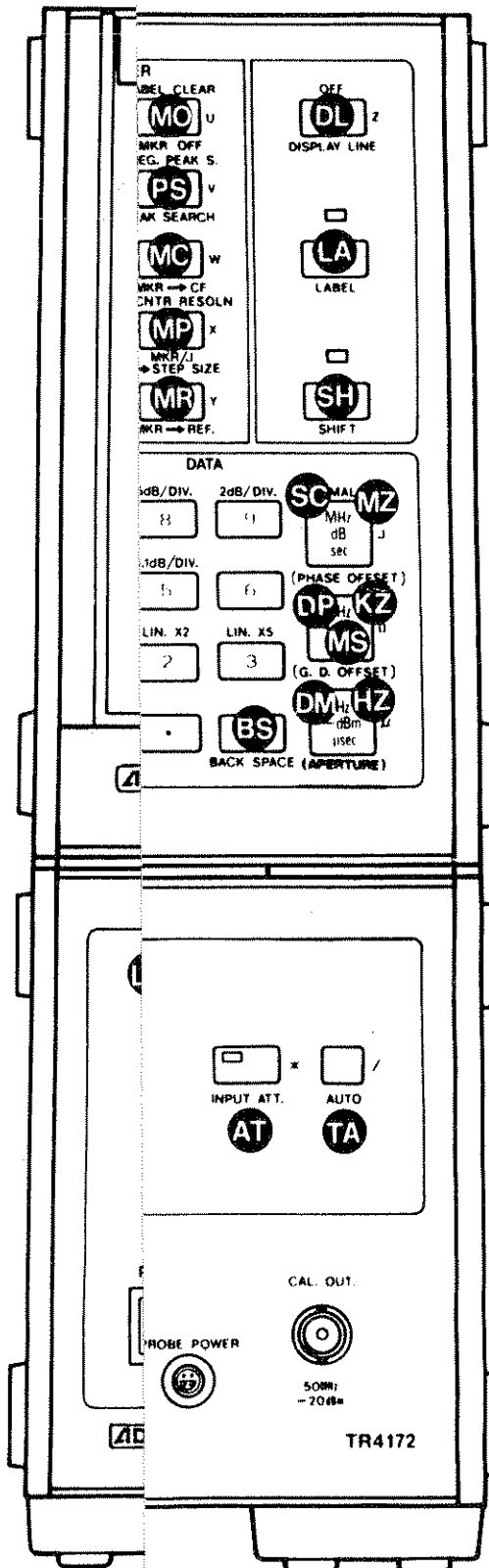
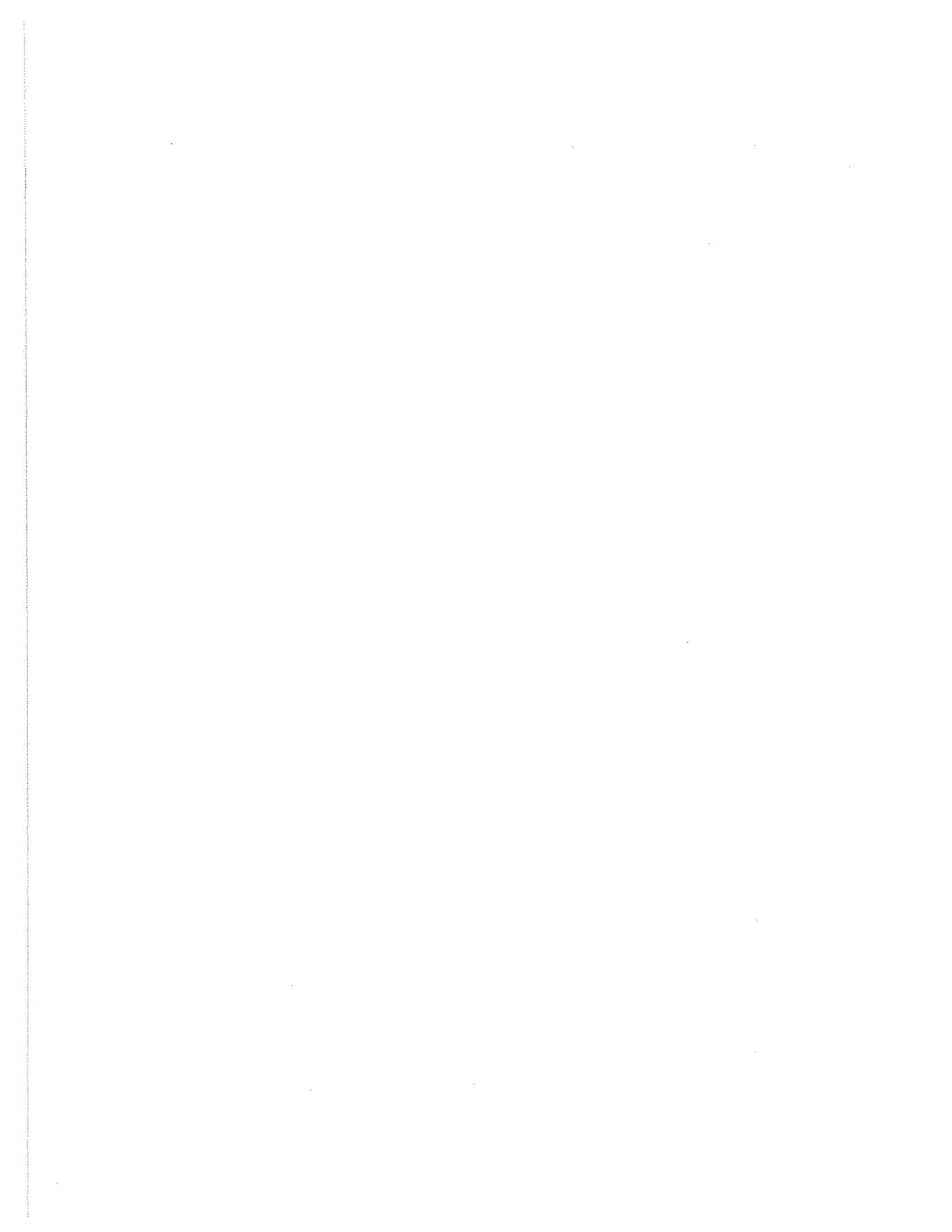

Fig 8 - 4 BPIB Command



SECTION 9
IMPEDANCE MEASUREMENT

9-1. GENERAL

The TR4172, when combined with the VSWR bridge, provides a Smith chart display on the TR4172's CRT display to allow for impedance measurement. It also permits direct readout of VSWR, reflection coefficient, and normalized impedance values useful for reflection wave analysis. In addition, the TR4172 makes various arithmetic and logical operating features using the internal CPU available for impedance measurement, offering the high-stability, high-sensitivity measurement for which the TR4172 is designed.

This section describes the theory of impedance measurement, the calibration procedure required for impedance measurement, and explains the impedance measurement procedure in some detail.

The impedance measurement mode is selected by pressing



. Once this mode is selected, functions of the control keys on the front panel are different from the usual ones. The key functions available in this mode are listed in Figure 9-34.

9-2. THEORY OF OPERATION

When a VSWR bridge is connected across the TRACKING GENERATOR OUTPUT and INPUT-1 of the TR4172 Analyzer and a Device Under Test (DUT) is connected to the Analyzer via this VSWR bridge, a signal proportional to the reflection from the DUT is input to INPUT-1. If the DUT terminals on the bridge are shorted or open (full reflection), the input to the INPUT-1 is maximized; if a characteristic impedance of the bridge is connected to the DUT terminals, then the input to INPUT-1 is minimized.

TR4172

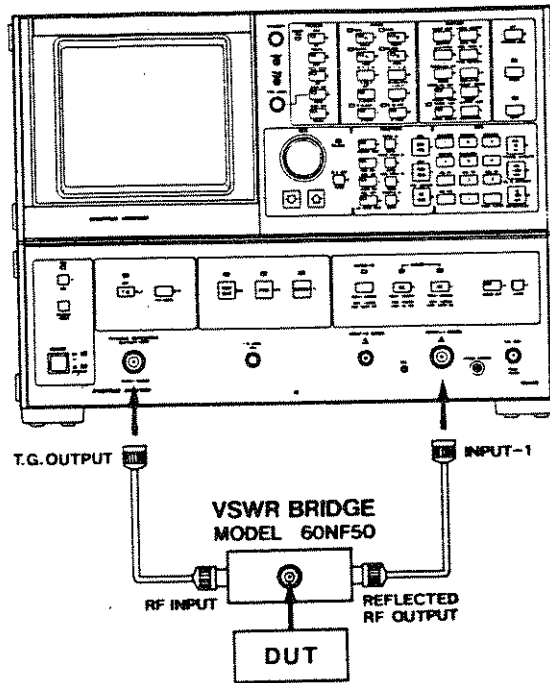

Fig. 9-1 Impedance measurement setup

The return loss of the DUT (difference between the reflection from the DUT and full reflection) can be determined by reading the input level on a logarithmic scale. If the input amplitude is displayed on a linear scale and the reference level is set to the full reflection level, the reflection coefficient can be directly read out at a resolution of 0.1 div. Furthermore, the reflection coefficient can be handled as a vector by phase measurement.

Figure 9-2 shows how the TR4172 reads phase information upon the first sweep, then reads amplitude information of linear scale upon the second sweep.

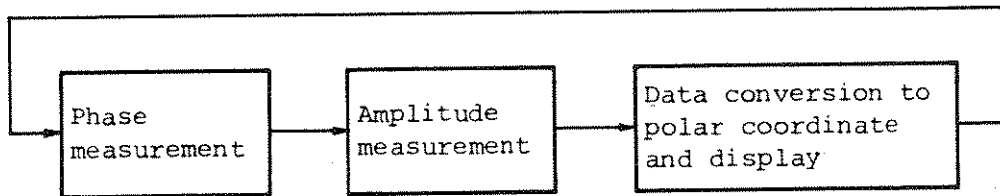

Fig. 9-2 Impedance measurement and display information flow

The information is then translated into polar coordinate data by arithmetic operation and displayed on the monitor (see Figure 9-3). Figure 9-4 shows amplitude, phase, and polar-coordinate displays for the same device under test.

A normalized impedance value can be read by superimposing a Smith chart on the reflection coefficient data displayed on a polar coordinate. Since the TR4172 can show a Smith chart on the display, approximated normalized impedance can be read from the display.

When a marker is used, the marker frequency, VSWR, reflection factor, phase, and normalization impedance are digitally displayed. For the TR4172, transfer characteristics can be displayed with vectors using only the polar-coordinate display function. In this case, directly connect DUT between TRACKING GENERATOR OUTPUT and INPUT-1.

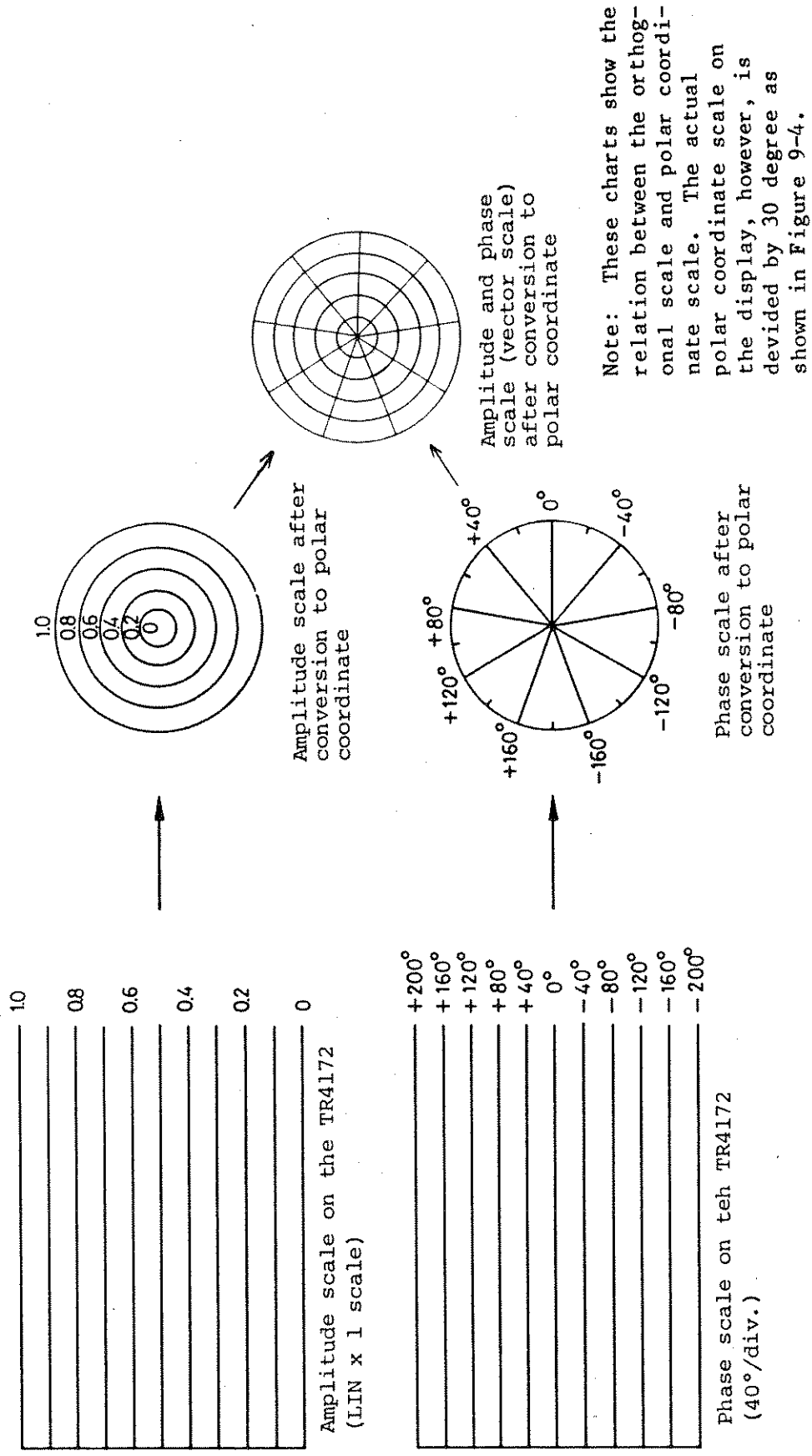
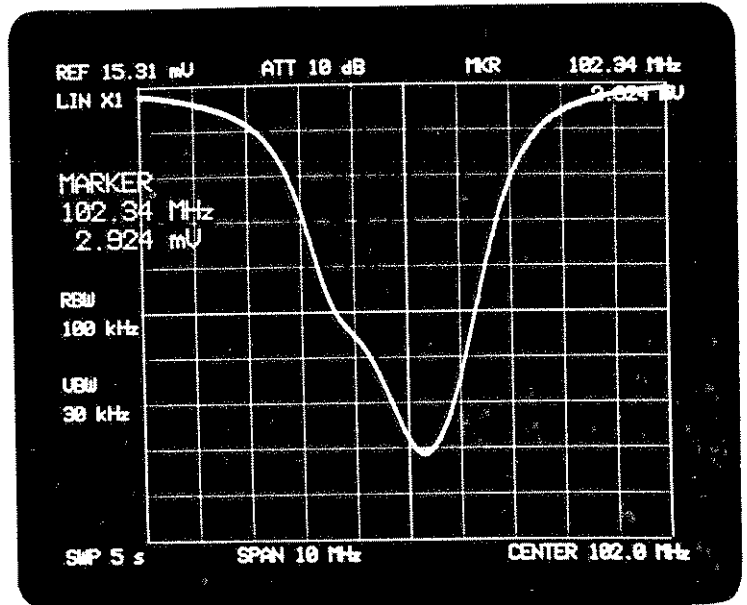
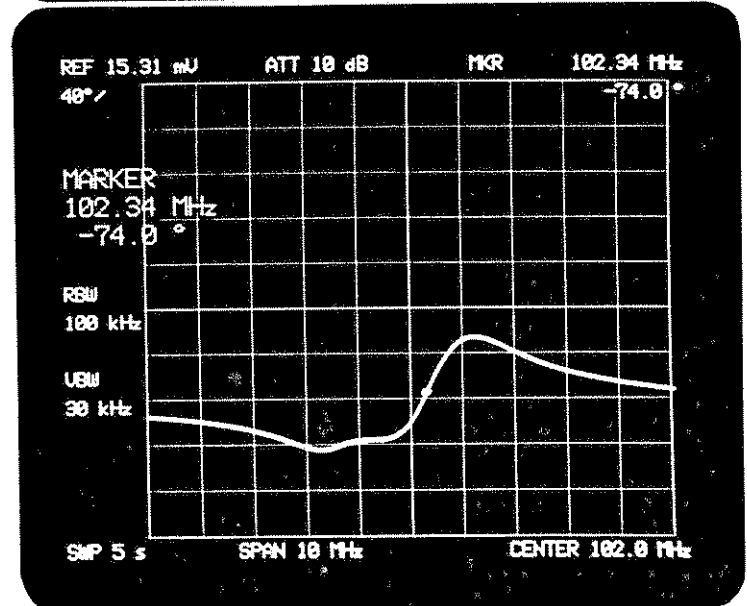

Fig. 9-3 Amplitude and phase information translated into polar coordinate data

Amplitude display



Phase display



Polar coordinate display

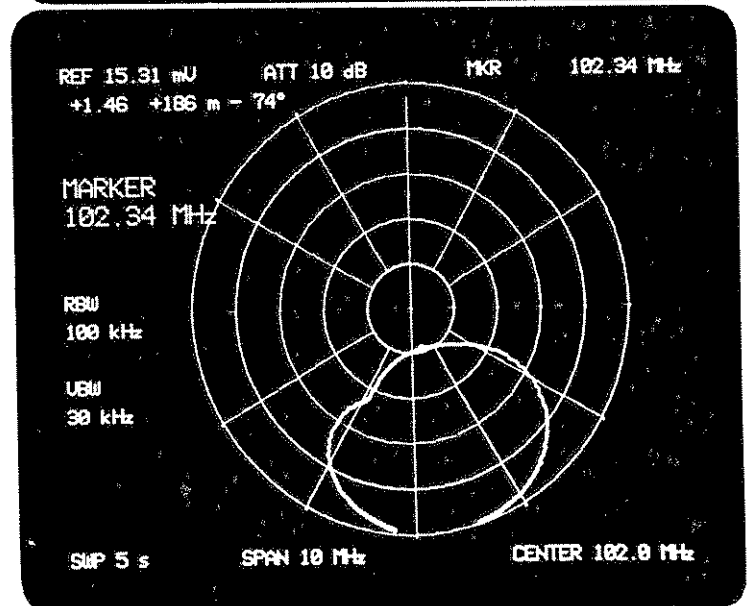

Fig. 9-4 Amplitude, phase, and polar-coordinate displays for the same DUT

9-3. CALIBRATION

9-3-1. General

When measuring impedance or reflection-coefficient using a VSWR bridge, calibration must be done to cancel the loss of the VSWR bridge, electrical length of the cable, and other error factors. For this calibration, a short or open plug is connected to the DUT terminals on the VSWR bridge instead of a real DUT, and the reference level, group delay offset, and phase offset are adjusted so the display data comes to the 0Ω or $\infty \Omega$ point on the Smith chart. When a frequency span of several 10 MHz or more is selected, however, satisfactory calibration may not be possible due to the nonlinear frequency response of the tracking generator or VSWR bridge. In order to solve this problem, the TR4172 contains a frequency response correction feature for both amplitude and phase. Since calibration directly affects measurement accuracy, the open or short plugs used should have nearly ideal characteristics in the given frequency range.

9-3-2. Preparation for Calibration

Connect the VSWR bridge across the TRACKING GENERATOR OUTPUT and INPUT -1 of the TR4172 by means of interconnecting cables DGM010-00150EE (see Figure 9-5).

TR4172

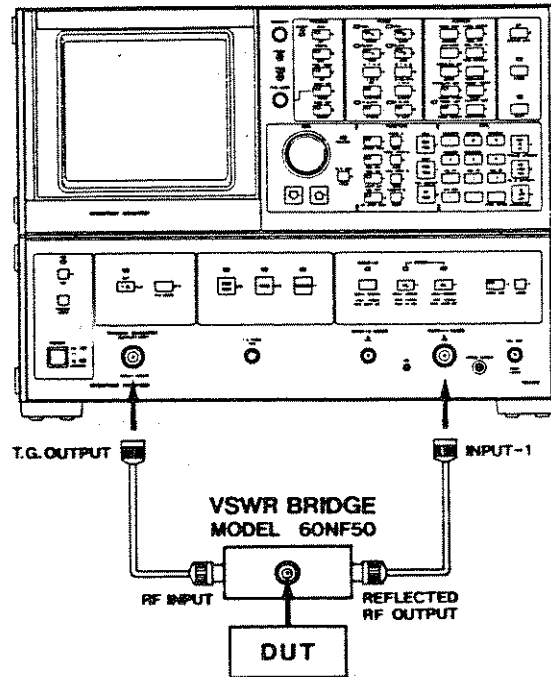

Fig. 9-5 Calibration system setup

The recommended VSWR bridge is 60NF50.

Connect the DUT across the terminals on the VSWR bridge, then press the TG key to activate the tracking generator output. While viewing the pass-band response of the DUT, set up the center frequency, frequency span, and other necessary parameters. Use the TG LEVEL key to adjust the signal level applied to the DUT. The signal level actually applied to the DUT is 6 dB to 7 dB lower than the tracking generator output level (when the recommended VSWR bridge is used). Since impedance measurement involves phase measurement, press the SWEEP TIME key, then manually select the appropriate sweep time with the DATA knob or other control means.

9-3-3. Calibration Procedure

Disconnect the DUT from the terminals on the VSWR bridge, and connect an short or open device to the terminals. If the DUT is connected by a cable, leave the cable connected to the terminals, and connect the short or open device to the end of that cable. In some frequency area, an open connector has its own capacity. In this case, use a short connector.

Press the PHASE key to observe phase response, then adjust group delay offset with the kHz (G.D. OFFSET) key until phase rotation is cancelled out.

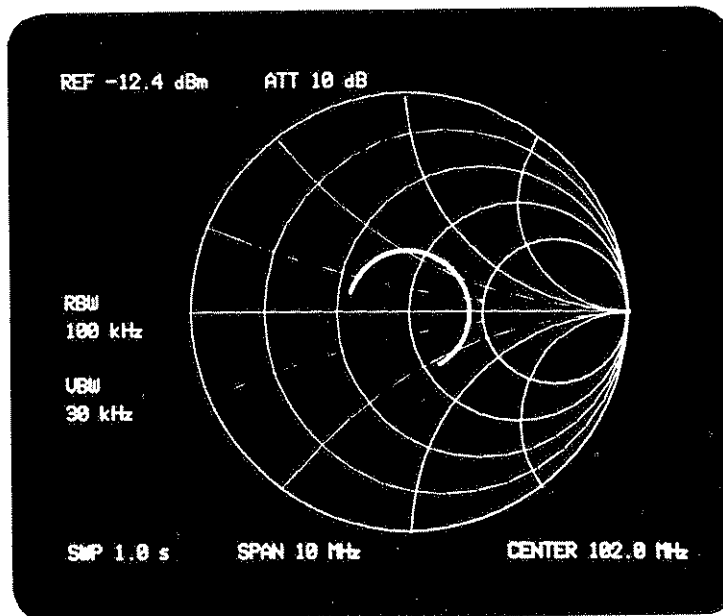

Fig. 9-6 Impedance measurement start

Press to activate the impedance measurement
SHIFT LABEL O

Figure 9-6 shows a Smith chart on the display, and impedance measurement sweep is started to display the measurement information translated into polar coordinate data. The display information is updated every other sweep.

The center frequency, frequency span, and other parameters set up during preparation are also maintained during impedance measurement. Press the REF LEVEL key, then use the DATA knob to align the measurement information to the outermost circumference of the Smith chart.

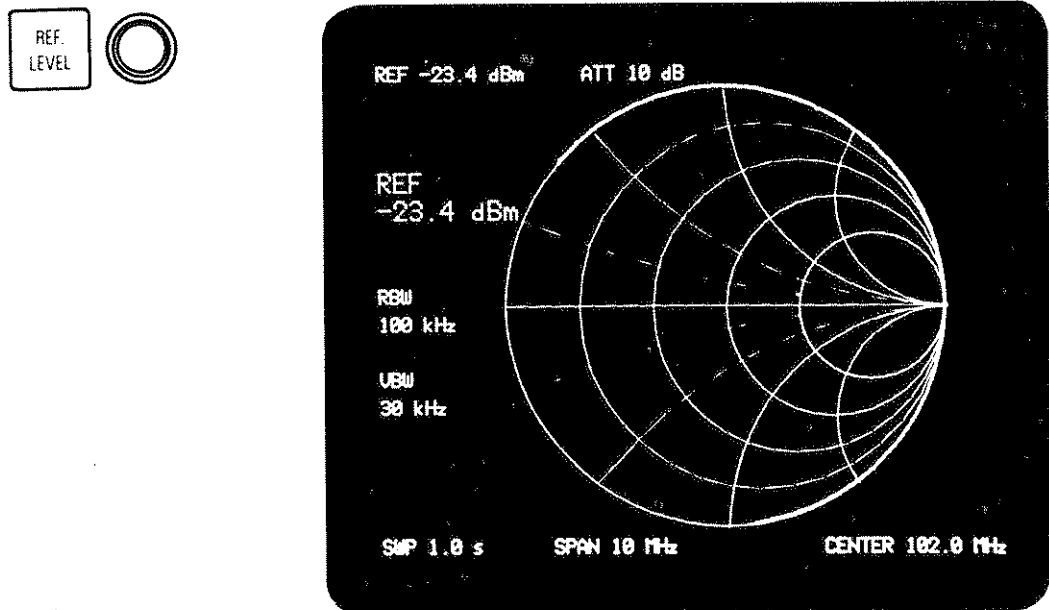

Fig. 9-7 Positioning the display information to the outermost circumference of the Smith chart

Press , then use the DATA knob to converge the display data to as small a point as possible. For finer adjustment, press the kHz key before controlling the DATA knob. To prevent the bright data spot from burning the display screen, press the PEAK SEARCH (POINT DEC.) key several times to reduce the number of data points. As mentioned earlier, the impedance measurement mode causes the control keys on the front panel to have functions different from their normal functions. For those functions refer to Figure 9-34.

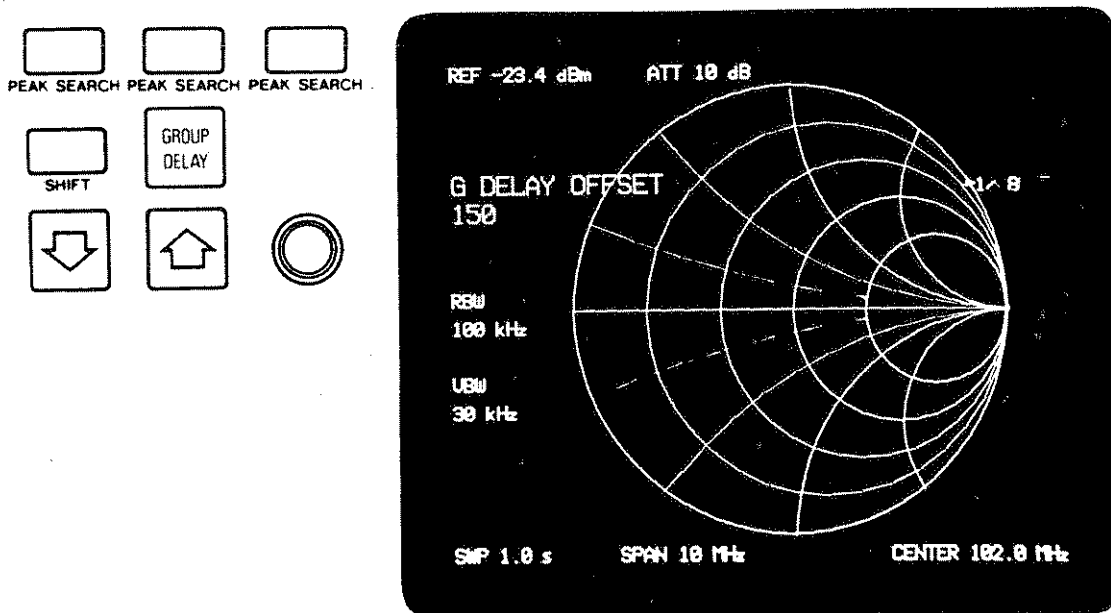

Fig. 9-8 Converging the display data to a small spot

Press , then use the DATA knob and step keys to cancel phase offset. If an open device is connected to the DUT terminals on the VSWR bridge, position the data spot to the $\infty \Omega$ point (right-hand end) on the Smith chart. If a short device is connected to the terminals, position the data spot to the 0Ω point (left side) of the Smith chart.

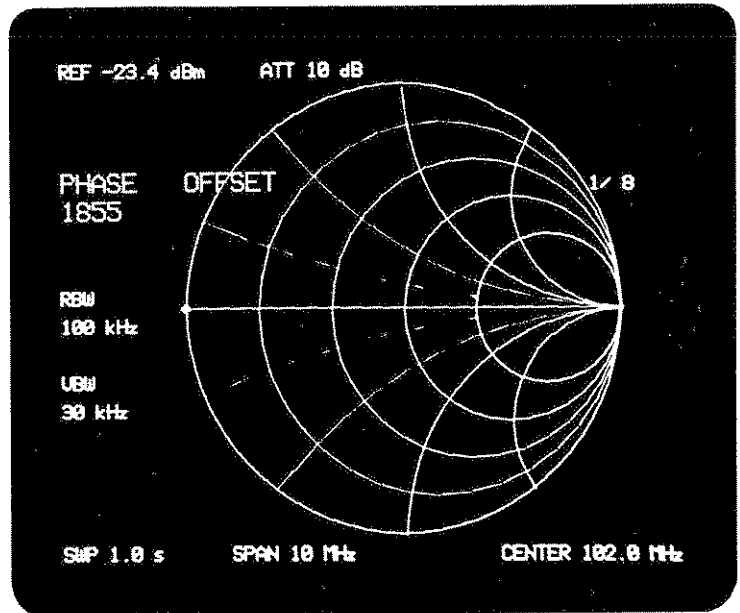
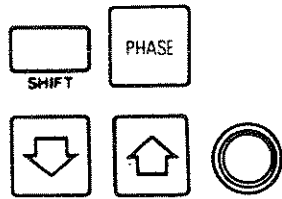

Fig. 9-9 Calibration for DUT terminal open

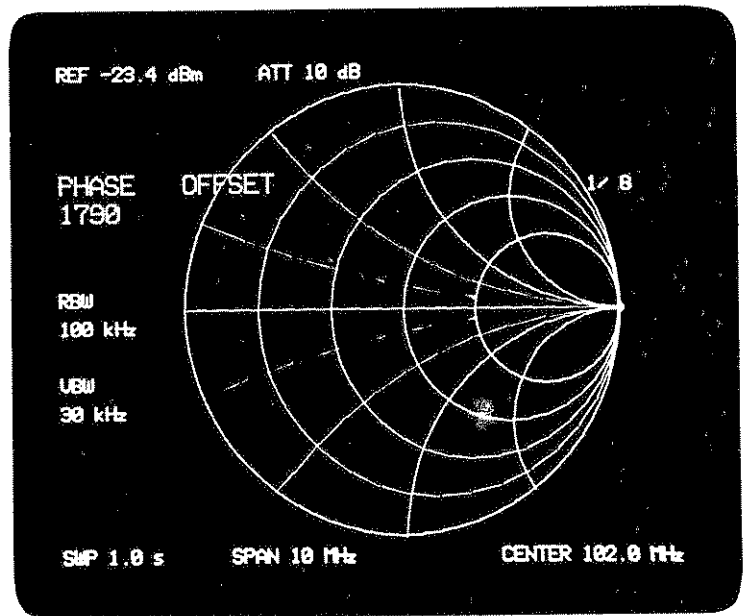
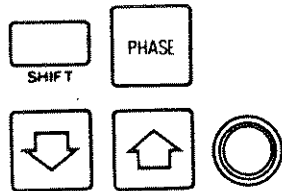





Fig. 9-10 Calibration for DUT terminal shorted

Calibration has now been completed. The same calibration procedure may be used for the amplitude and phase measurement mode while viewing the orthogonal coordinate (and by using the relationship shown in Figure 9-3). In this case, calibration time will be shortened since display updating interval for the orthogonal coordinate is shorter than that for the Smith chart.

9-3-4. Correcting frequency characteristics (Normalization)

This frequency correction mode allows correction data measured by A WRITE to be used for B WRITE as well, because it does not go through A-B → A unlike the normalize mode that is effected by  , .

In this correction mode, waveform data on 0 to 2,000 MHz (1,001 points) is stored as reference waveform data. Accordingly, even if the setting of  or  is altered, the corrected value can be calculated from the 1,000 points of waveform data to continue with normalization. The narrower the span, however, the coarser becomes the corrected value. To use reference waveform data, set the POWER switch to STANDBY. The reference waveform data can be erased by pressing the MASTER RESET key and performing a vertical axis scale change operation.

Note: This function is not operative while the screen vertical axis is T1 dB/DIV., 0.5 dB/DIV., 0.2 dB/DIV., or 0.1 dB/DIV and the TR4172 is in the PHASE or GROUP DELAY mode.

a. Storing reference waveform data and correcting frequency characteristics

- ① Set the TR4172 in the TG mode, then in the A WRITE mode by pressing .
- ② Interconnect the TRACKING GENERATOR OUTPUT connector and the INPUT-1 connector directly with the supplied cable MI-04.
- ③ After setting CENT.FREQ. to 1000 MHz and FREQ.SPAN to 2000 MHz, lower the reference level to confine the through waveform within the grid in the upper part of the screen.

④ Press , , ^M , and the frequency characteristics are corrected on the basis of the 50 MHz level of the through waveform. The range of correction is + 120 points of the 50 MHz level. At this time, the reference waveform data is stored in memory.

Note: During this operation, the TR4172 is automatically set to A' BLANK, A WRITE, CENT.FREQ. 1000 MHz, and FREQ.SPAN 2000 MHz.

b. Switching corrected frequency characteristics automatically or manually

Press , , ^J , and the following messages will be displayed:

FREQ. CHARACT. CORR.

'1' HAND OPERATED

'0' AUTO CORR

If you press the numeric keypad key 1 , even though the setting of CENT.FREQ. or FREQ.SPAN is altered, the corrected values can be calculated by pressing , [·] after the change to continue with normalization.

If you press the numeric keypad key 0 , the corrected values are calculated each time the setting of CENT.FREQ. or FREQ.SPAN is altered, thus allowing continued normalization.

c. Selecting or deselecting corrected frequency characteristics

Press , , ^J , and the following messages will be displayed:

FREQ. CHARACT. CORR.

'1' DO NOT USE CORR.

'0' USE CORR.

If you press the numeric keypad key 1 , the correction of frequency characteristics is suppressed.

If you press the numeric keypad key 0 , corrected values are calculated from the reference waveform data stored in memory to set the TR4172 in the normalize mode.

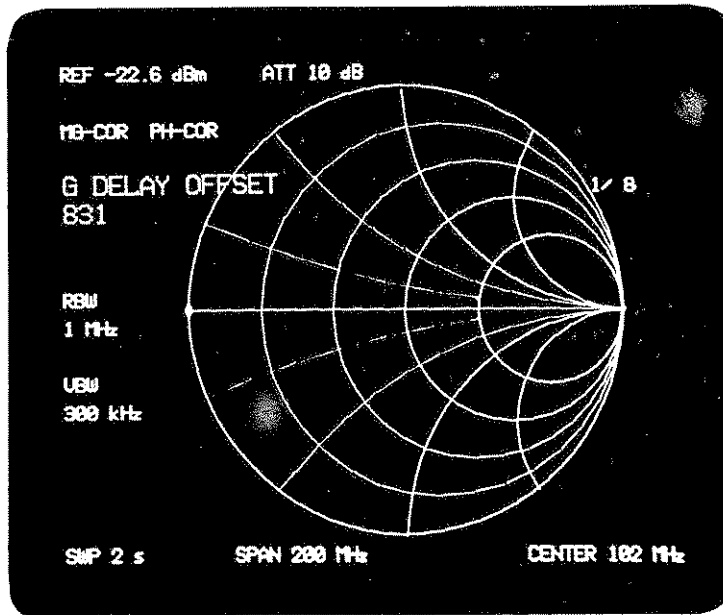

Fig. 9-11 Frequency response correction in the amplitude domain

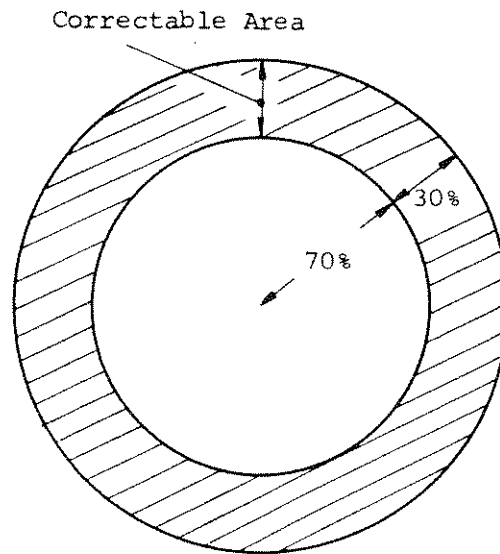

Fig. 9-12 Amplitude-frequency response correctable range

9-3-5. Calibration in Enlargement Mode

The center portion of a Smith chart display can be enlarged 10 times by pressing the (MAG. x 10) key. The enlargement will result in a slight phase error. To cancel this phase error, connect an open or short device to the DUT terminals on the VSWR bridge, and adjust phase offset so that the phase is 0° for an open terminal or 180° for a shorted terminal. When the display data overscale, that is unimportant.

If the (MAG. x 10) key is pressed again, the Smith chart display of normal size will be restored. In this case also, carry out phase calibration. If the slight phase error occurring in the enlargement mode is insignificant, the phase calibration may be omitted.

9-4. MEASUREMENT

9-4-1. Measuring Procedure

Accurate calibration is a vital factor for precision impedance measurement. Once calibration is completed, do not change the center frequency, frequency span, reference level, or other parameter setting. If any change is effected on these parameters, carry out calibration again.

After completing calibration, connect the DUT across the DUT terminals on the VSWR bridge. The impedance of the DUT can now be read on the Smith chart display. Figures 9-13, 9-14, and 9-15 show the three types of scales used for this option. Figure 9-13 shows a Smith chart from which a normalized impedance can be read. The normalized impedance at the point indicated by a small mark "o" in this figure is read as $0.2 \Omega - j0.5 \Omega$. Figure 9-14 shows a polar coordinate from which a reflection coefficient can be determined. The reflection coefficient at the point identified by small mark "o" in this figure is read as $0.8 \angle 60 \text{ deg}$. Figure 9-15 shows another Smith chart whose center portion is enlarged tenfold. A normalized impedance in the vicinity of 1 can be determined from this chart at a high resolution. The normalized impedance at the point indicated by a small mark "o" in this figure is read as $1.1 \Omega - j0.1 \Omega$.

The impedance can be determined by multiplying the real and imaginary parts of the normalized impedance each by 50 (when the characteristic impedance of the bridge is 50Ω).

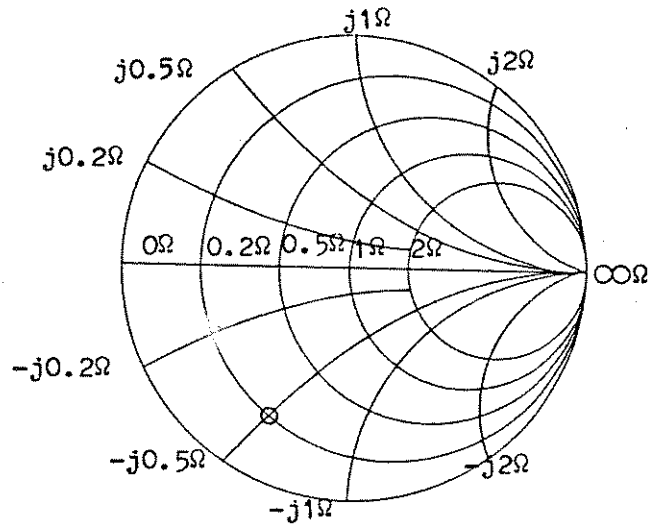

Fig. 9-13 Smith chart

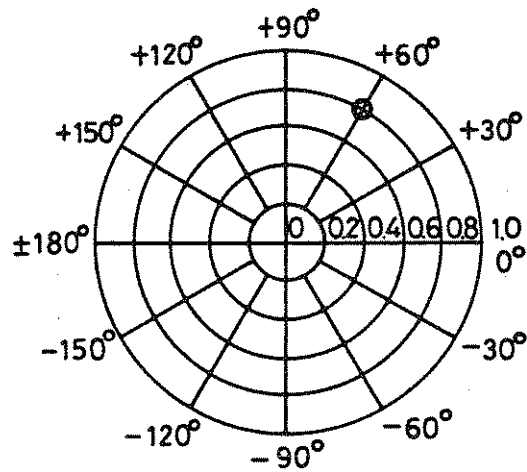

Fig. 9-14 Polar coordinate

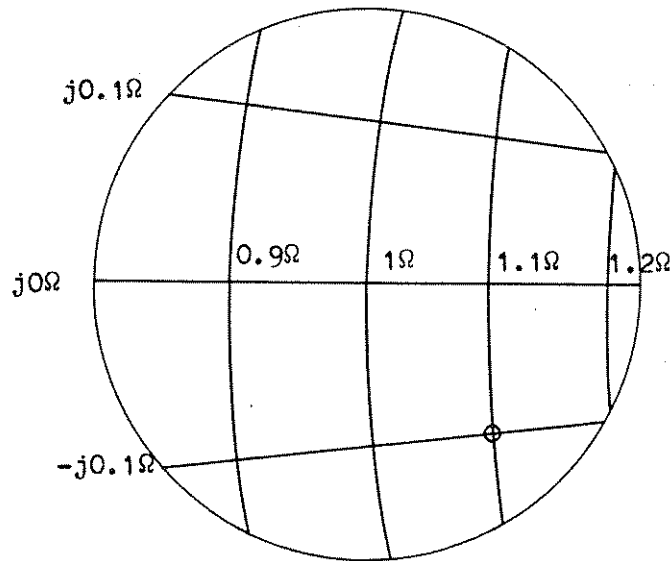

Fig. 9-15 Enlarged Smith chart

The frequency of the display data can be read with a marker activated by operating the key. In addition to the frequency, the MARKER will also provide direct readouts for the VSWR, reflection coefficient, phase, normalized impedance, and inductance or capacitance of the equivalent serial circuit. The normalized impedance and inductance or capacitance of the equivalent serial circuit are not shown on the polar coordinate display, however. Figure 9-16 shows a data display example using a marker. Calculated data readouts for the marker point are shown on the third line on the screen. The readouts are VSWR, reflection coefficient, phase, normalized impedance, and inductance or capacitance, from left to right. The top information line on the display is reserved for user-defined Label information. If no label is written in this area, however, the titles for the data readouts shown on the third line are shown on this top line instead. If even one character of label information is entered in this line, the title will not be shown. While normalized impedance, inductance, and capacitance each have three significant digits, it should be noted that they may include a large error if the real or imaginary part of the impedance to be measured is extremely large or extremely small with respect to the characteristic impedance.

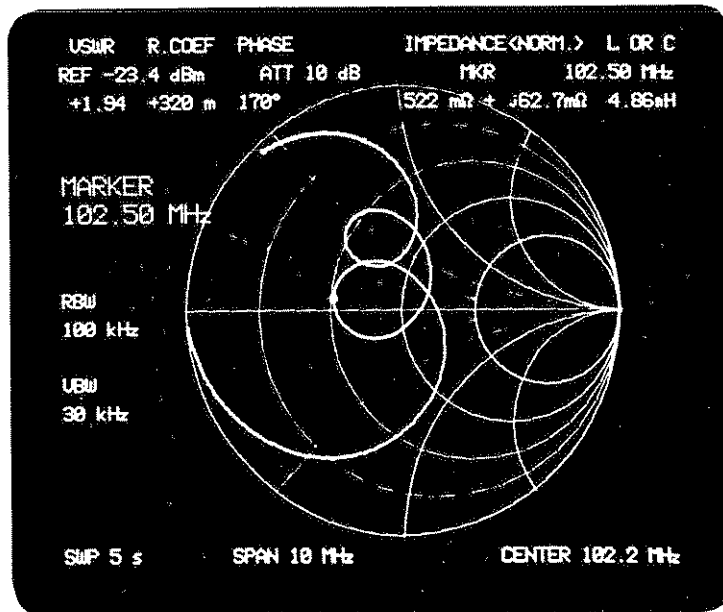

Fig. 9-16 Data readout for marker point

The data readouts for the marker point are updated every other sweep. If the measurement information is held with the A key, however the data readouts will be updated with marker movement.

The measurement information hold state can be cleared by pressing the A F (CLEAR WRITE) key.

As with the normal measurement mode, the center frequency, frequency span, reference level, and marker can be set up with any of the DATA knob, DATA step keys, and numeric data keyboard.

To clear the impedance measurement mode, press the B K (EXIT) key. At this time, the center frequency, frequency span, and other parameter setup are left intact, so that data comparison can be easily made between the normal mode and impedance measurement mode (e.g. a return loss is measured on the logarithmic scale, and the impedance is measured in the impedance measurement mode).

The basic impedance measuring procedure is described above. The following paragraphs describe various additional features available in the impedance measurement mode to facilitate measurement.

9-4-2. Usage of Additional Features

In the impedance measurement mode, there are some inoperative or unnecessary keys on the front panel. These keys are either made ineffective or assigned functions unique to this mode. (See figure 9-34.) Some keys with new function assignments are alternately activated and deactivated each time they are pressed. Some other keys are used to increment or decrement setup values (e.g. intensity) each time they are pressed. The lamps in these keys are not activated, but the setup conditions are shown on the display. VSWR or reflection coefficient values are displayed with engineering units such as "m" or "k". For instance, 12.3 m means 0.0123. The following paragraphs describe each additional function:

(1) Scale controlling function

^A select the Smith chart, and ^B select the polar coordinate scales respectively. If the ^R (MAG. x 10) key is pressed when the Smith chart is selected, the reference level is reduced to one-tenth, and the center portion of the chart is enlarged tenfold. (See figure 9-17.) At this time, phase offset must be canceled if necessary. (See paragraph 9-3-5.) Pressing the ^R key again will restore the normal Smith chart and the original reference level.

(2) VIEW mode and impedance measurement mode clear

Operation of ^A_{VIEW}^G key stops sweep and holds measurement information on the display, so that photographing is facilitated. At this time, message "VIEW" will be shown in the right information area on the display. To clear the information hold state, press ^A_{CLEAR WRITE}^F key. Pressing ^B_{EXIT}^K key clears the impedance measurement mode and returns the instrument to the normal measurement mode.

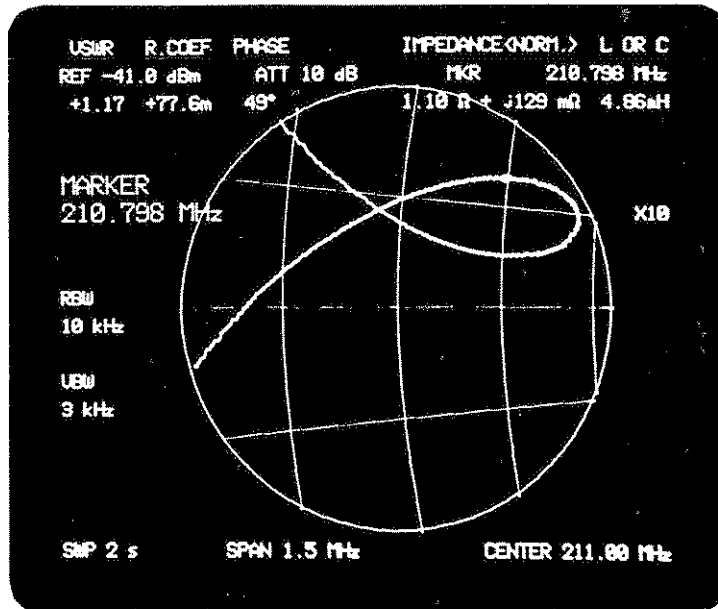



Fig. 9-17 Enlarged Smith Chart

(3) Increment and decrement of data points

Measurement data on the display usually consists of 500 data points. The number of data points can be reduced in half however, to 1/32 each time the  (POINTS DEC.) key is pressed. The reduction ratio is shown on the display as, for example, 1/16. To increase the number of data points, press the  (POINTS INC.) key. The number of data points is doubled each time this key is pressed. (See Figure 9-18.)

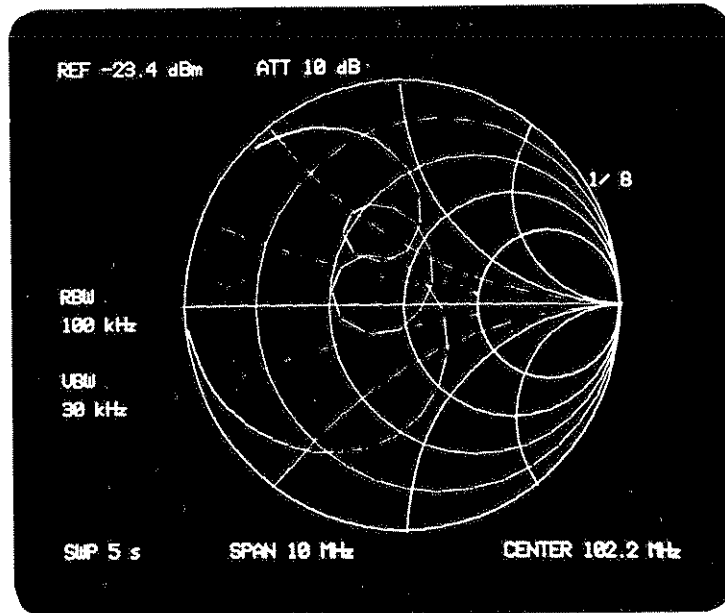





Fig. 9-18 Increment and decrement of data points

When measurement data is converged to one small spot on the display, reduce the number of data points to prevent the CRT from spot burn. If the number of data points is reduced, the time required for polar coordinate translation can be reduced accordingly.

(4) Reading numeric values from measurement data

In addition to markers, display circles, and start and stop markers can be used to read numeric values from measurement data. Pressing (DISP. CIRCLE) draws a concentric circle with respect to a specified coordinate location, with the message 'DISPLAY CIRCLE' appearing on the screen. The radius of this circle can be altered using  or  . When the radius of the circle is altered, the VSWR and the reflection coefficient corresponding to its circumference are displayed in the lower left corner of the CRT screen.

Pressing (DISP. CIRCLE) again turns off the display circle.

Pressing (START STOP) displays the start and stop

frequencies of the sweep, with the message 'START STOP' appearing on the screen. In a regular rectangular coordinate system, the start frequency corresponds to the leftmost end of the frequency axis, and the stop frequency corresponds to the rightmost end of the frequency axis. At the same time, triangular markers point to the start and stop points. The start and stop points are indicated by an acute-angled triangle and an obtuse-angled triangle, respectively.

Pressing B (START STOP) again erases these markers. The Y key causes the display circle to overlap the marker.

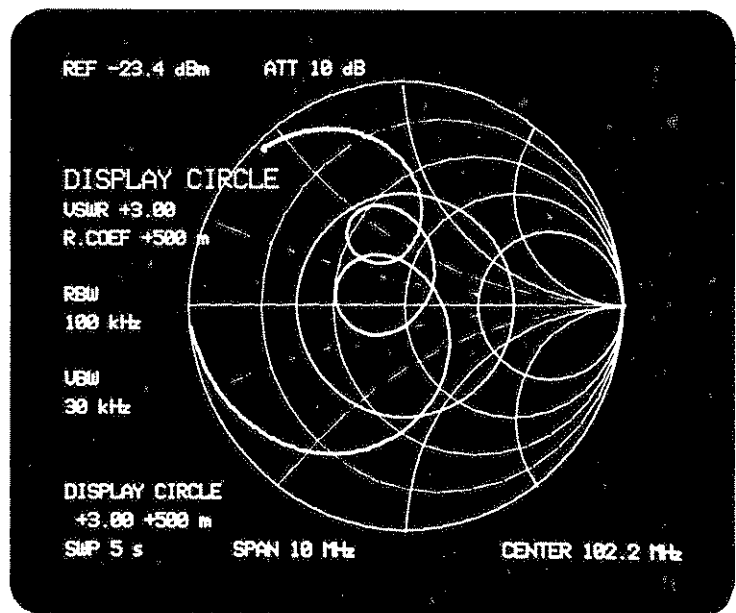

Fig. 9-19 Display circle

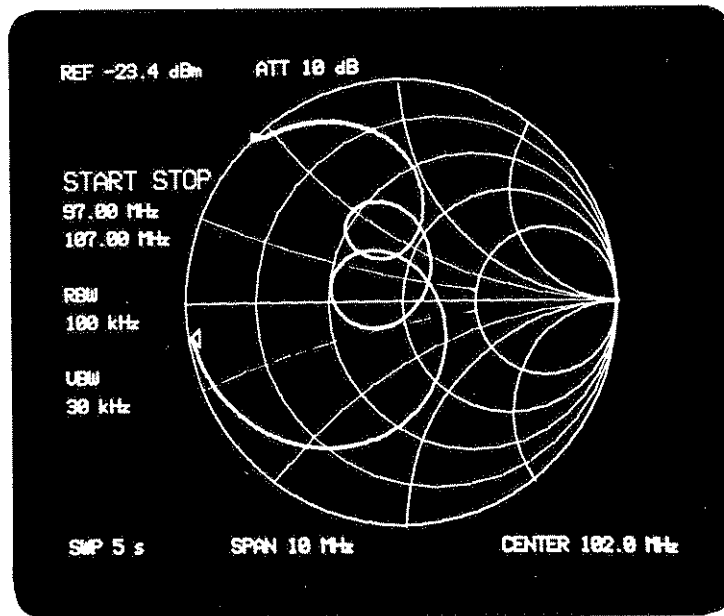

Fig. 9-20 Start and Stop markers

(5) Multimarker listing function

Multimarker setting is effected by following the same procedure as in normal mode. When a number of markers are displayed with the multimarker, pressing the ^M switch allows the values of the frequency, normalized impedance, and serial equivalent inductance or capacitance at up to 10 marker points to be listed on the display. The active marker is identified by an asterisk (*) to the left of its point number. If a display circle has been displayed, "IN" or "OUT" indicates whether a marker point has entered the circle or not.

Pressing the ^M switch here displays a list of VSWR values, reflection coefficients, and phases.

Pressing the ^M switch next will cancel this mode.

Be sure to press the ^A switch to hold measurement data before entering this mode.



MULTI MARKER LIST

NO.	MARKER FREQ.	IMPEDANCE<NORM.>	L OR C	IN/OUT
1	97.00 MHz	25.2mΩ + J598 mΩ	41.7nH	OUT
* 2	98.00 MHz	51.1mΩ + J587 mΩ	47.7nH	OUT
3	99.00 MHz	134 mΩ + J759 mΩ	61.1nH	OUT
4	100.00 MHz	800 mΩ + J948 mΩ	75.4nH	OUT
5	101.00 MHz	512 mΩ + J583 mΩ	45.9nH	OUT
6	102.00 MHz	948 mΩ - J180 mΩ	173 pF	IN
7	103.00 MHz	870 mΩ + J483 mΩ	31.1nH	IN
8	104.00 MHz	392 mΩ - J732 mΩ	41.8pF	OUT
9	105.00 MHz	72.1mΩ - J324 mΩ	93.7pF	OUT
10	106.00 MHz	23.8mΩ - J140 mΩ	215 pF	OUT

Fig. 9-21 Normalized impedance and L/C listing



MULTI MARKER LIST

NO.	MARKER FREQ.	VSWR	R. COEF	PHASE	IN/OUT
1	97.00 MHz	+57.8	+966 m	126°	OUT
* 2	98.00 MHz	+28.4	+932 m	119°	OUT
3	99.00 MHz	+12.3	+850 m	105°	OUT
4	100.00 MHz	+2.85	+480 m	74°	OUT
5	101.00 MHz	+2.79	+472 m	109°	OUT
6	102.00 MHz	+1.22	+98.0m	-101°	IN
7	103.00 MHz	+1.57	+222 m	96°	IN
8	104.00 MHz	+4.13	+610 m	-102°	OUT
9	105.00 MHz	+16.2	+884 m	-144°	OUT
10	106.00 MHz	+49.0	+950 m	-164°	OUT

Fig. 9-22 VSWR, reflection coefficient, and phase listing

(6) Frequency response correction feature

This feature is used for pre-measurement calibration. Operation of the (MAG. COR.) key selects the amplitude frequency response correction mode. Pressing the (MAG. CAL.) key effects calibration. If there is any data outside the correctable range, an error will result, with an ERROR message shown on the display. During calibration busy, the indicator "CAL" is also shown on the display. This correction mode is cleared by pressing the (MAG. COR.) key again.

Operation of the (PHASE COR.) key selects the phase frequency response correction mode. To execute calibration, press the (PHASE CAL. (O)) key when the DUT terminals on the VSWR are open, and press the (PHASE CAL (S)) key when the terminals are shorted. During calibration busy, indicator CAL <O> or CAL <S> is shown on the display. This correction mode is cleared by pressing the (PHASE COR.) key again.

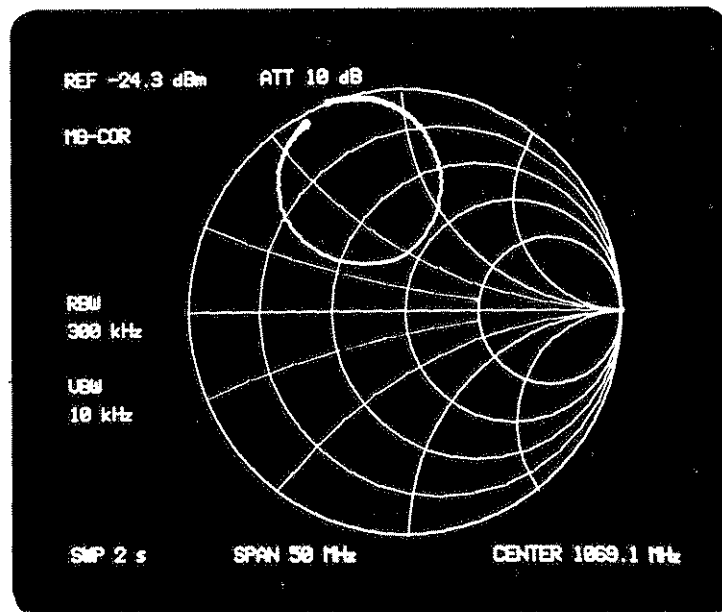

Fig. 9-23 Amplitude response correction mode

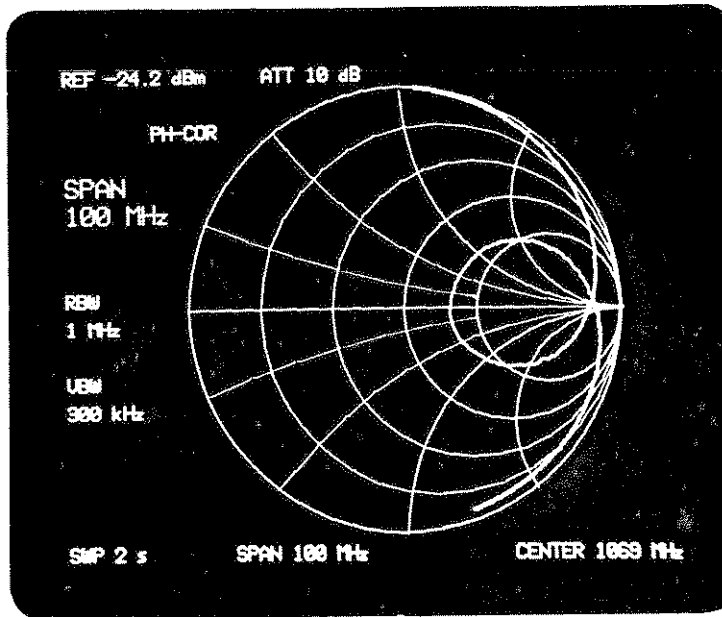

Fig. 9-24 Phase response correction mode

(7) Other features

Each operation of the τ (CONTRAST) key increments only the intensity of the displayed impedance response trace or the graticule. The character information readouts remain at the same intensity. Operation of this key first increases the trace intensity in four levels; if the τ (BRIGHT) key is pressed a fifth time, the intensity returns to the original level. Next, operation of this key increases the graticule brightness. This trace and graticule intensifying feature is convenient for highlighting the impedance response trace for photographing, or other occasions.

Operation of the μ (HELP) key provides a listing of the special key functions used in the impedance measurement mode on the display (See Figure 9-25.)

```
**** IMPEDANCE OPTION FUNCTION SUMMARY ****
'A' SMITH CHART          'B' POLAR
'R' MAG X10 ON/OFF 'X10'
'F' CLEAR WRITE MODE    'B' VIEW MODE 'VIEW'
'U' DATA POINTS DEC. '1/2,—,1/32'
'W' DATA POINTS INC. '1/32,—,1/2'
'L' START STOP MARKER ON/OFF
'Z' DISPLAY CIRCLE ON/OFF 'DISPLAY CIRCLE'
'Y' MARKER->DISPLAY CIRCLE
'H' MULTI MARKER LIST IMP/USUR/OFF
'I' MAG CORRECTION ON/OFF 'MG-COR'
'J' MAG CAL. 'CAL'
'N' PHASE CORRECTION ON/OFF 'PH-COR'
'O' PHASE CAL.—OPEN 'CAL(O)'
'S' PHASE CAL.—SHORT 'CAL(S)'
'T' CONTRAST
'H' HELP MESSAGE ON/OFF

'K' EXIT OPTION
```

Fig. 9-25 Key function listing for impedance measurement mode

9-4-3. Measurement Examples

This paragraph provides an example of application of the impedance measurement mode, with bandpass filter response measurement as an example.

- ① Connect the DUT (filter) across the TRACKING GENERATOR OUTPUT and INPUT-1 of the TR4172, then set up the necessary measuring parameters (such as center frequency, frequency span, etc.) observing the pass-band response in the normal mode.

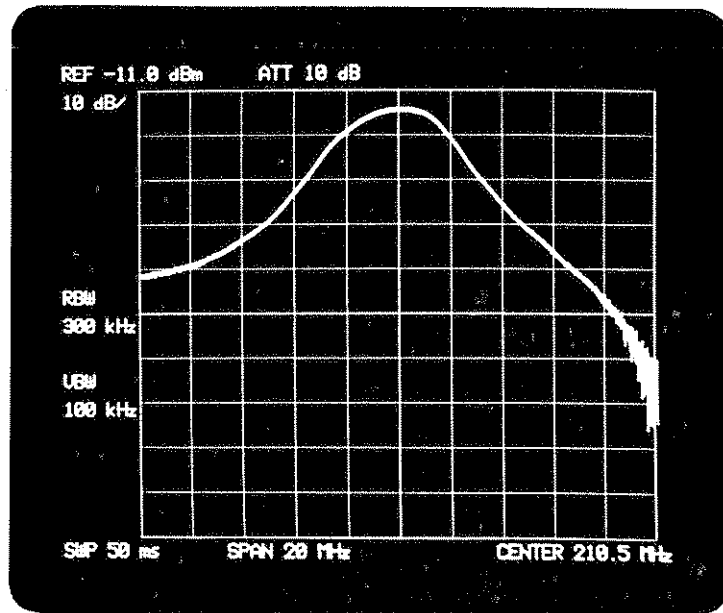
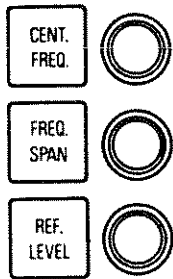



Fig. 9-26 Pass-band characteristic of band-pass filter

- ② Next, connect the VSWR bridge to the TR4172 instead of the DUT (filter) as shown in Figure 9-1, with the DUT left disconnected from the bridge. Activate a marker, and press the  key to position the signal response peak to the reference level.

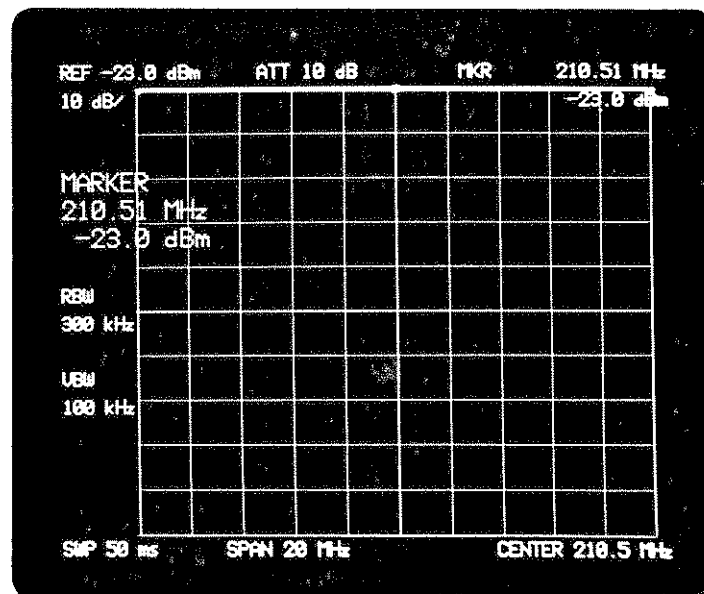

Fig. 9-27 Positioning the signal response peak to the reference level

- ③ Connect the DUT to the VSWR bridge. The return loss of the DUT can be read out as the level difference from the reference level.

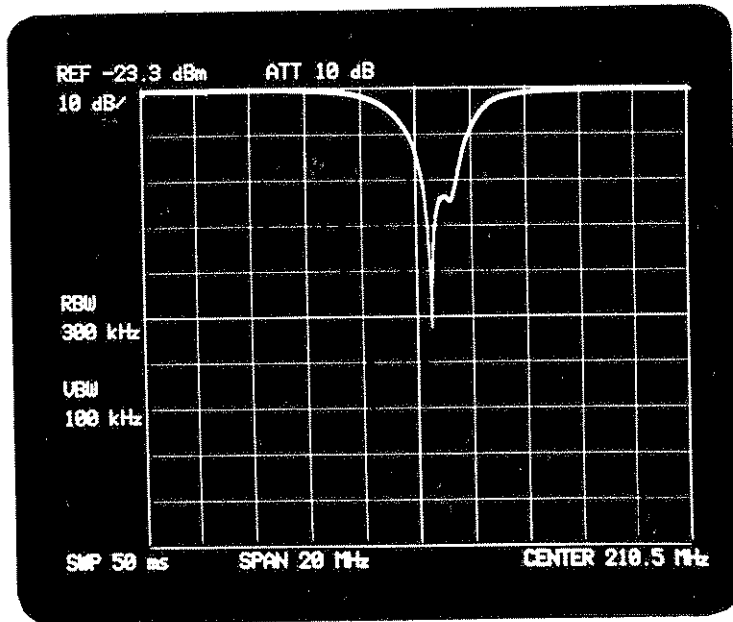

Fig. 9-28 Measurement of DUT return loss

- ④ Disconnect the DUT from the VSWR bridge, and instead connect an open or shorting device to the DUT terminals on the bridge. (If the terminals are simply opened, the connector capacity will cause an error; therefore, it is preferable that a highquality open or shorting device be connected across the terminals.) Perform calibration according to the instructions in 9-3-2 and 9-3-3. Calibration in the impedance measurement mode is time consuming. To reduce this time, set the sweep time at a relatively small value to make course calibration, then set sweep time to the optimum value to perform fine calibration. It is also recommended that the (POINTS DEC.) key be pressed several times in advance to reduce the number of data points and hence save calibration time. The calibration time may be further reduced if course calibration is done in the normal measurement mode (not in the impedance measurement mode) by utilizing the relationship shown in Figure 9-3.

- ⑤ After completing calibration, connect the DUT to the DUT terminals on the VSWR bridge, allowing measurement on a Smith chart. While in the normal measurement mode frequencies can be read from the scale, in the normal measurement mode, on the Smith chart they are read by markers. It is recommended therefore, to use the Multi Marker mode in the impedance measurement mode. In the impedance measurement mode as well, up to 10 multi markers are available, which will be useful for photographing or copy to the plotter.

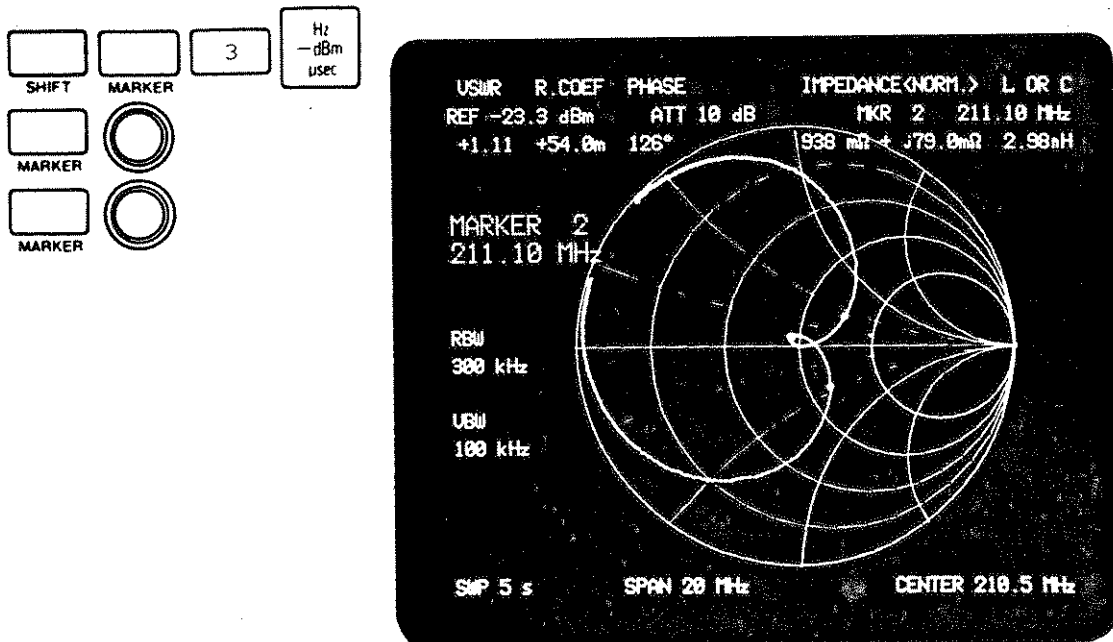



Fig. 9-29 Multi marker mode

- (6) To clear the impedance measurement mode, press the  (EXIT) key. The return loss display can be restored by pressing the  key.

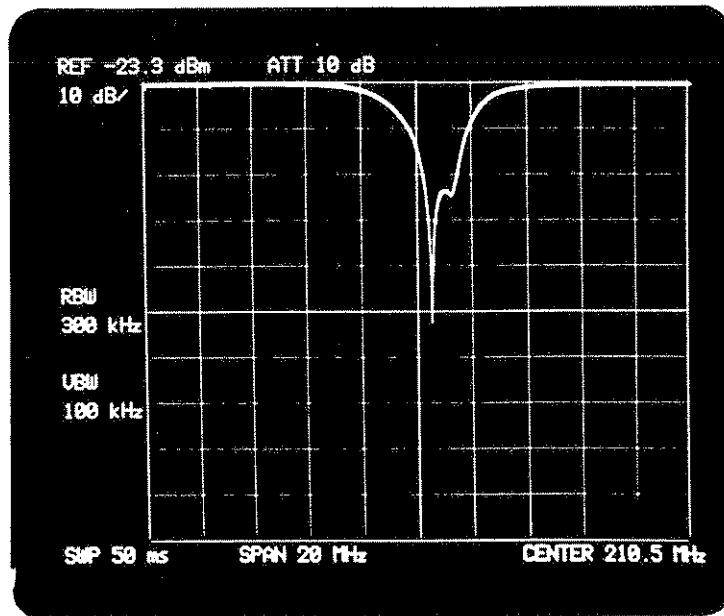

Fig. 9-30 Clearing the impedance measurement mode

9-4-4. Notes on Impedance Measurement

(1) The following keys have the same functions in both normal and impedance measurement modes:



• Function keys

• Data keys



• INPUT-1 (AC, DC)

• INPUT-2

•  T.G. LEVEL



•  INPUT ATT. and  AUTO



•  LABEL and  SHIFT  LABEL CLEAR



•  MARKER and  MKR OFF



•  Δ MULTI MKR

•  SHIFT 

•   GROUP DELAY (group delay offset)

•  SHIFT  PHASE (phase offset)





•   LABEL  Δ (plotter)

•  SHIFT  MASTER RESET

•  LCL

All parameters set up with these keys are left intact, whether the impedance measurement mode is set or not. All other keys are assigned functions unique to the impedance measurement mode, or are made inoperative. In either case, the lamps in those keys are off.

The impedance measurement mode can be entered whether the preceding mode was the amplitude, phase, or group delay mode or the preceding scale was linear or logarithmic. When the impedance measurement mode is cleared, the original mode and scale are restored. For example, if the impedance measurement mode is selected with amplitude measurement of 5 dB/div. in the normal mode, the amplitude measurement mode at 5 dB/div. is restored when the impedance measurement mode is cleared. Similarly, if the phase measurement mode of 80 deg/div. was selected before the impedance measurement mode was selected, the same phase measurement mode of 80 deg/div. is restored when the impedance measurement mode is unset.

- (2) When duplicating the display information on a plotter, press the     keys in the impedance measurement mode. All impedance measurement control functions can be remotely controlled over the GPIB. For example, an SH LA 0 sent from the controller to the instrument puts the instrument in the impedance measurement mode. The command PS PS causes the number of data points to be reduced to one-fourth, and the command BW clears the impedance measurement mode.
- (3) In the impedance measurement mode, display data is stored over 500 memory locations beginning from address C818. The scale data is stored in a memory area beginning from address C018. Each data point is represented by an orthogonal coordinate point of (x, y), and is stored as X1, Y1, X2, Y2, X3, Y3, and so on in ascending order.

Data should be taken out in decimal form by pressing the  key. Meaningful data is between 0 and 1023. Data beyond 1023 is blanking data, which should be ignored.

To convert the outer circumference of the scale into data (xn, yn) which represents a circle with its center located at (0, 0) and a radius of 1, use the following conversion formulas:

$$x_n = (x - 512)/500, y_n = (y - 512)/500$$

A basic programming example using the Hewlett Packard Model 9826 Controller is shown below. After executing this program, measurement information is plotted on the 9826 display.

```

10  GINIT
20  GRAPHICS ON
30  A=1.024
40  WINDOW -A*4/3.A*4/3.-A.A
50  OUTPUT 701;"RDC8180040 TO"
60  PEN -1
70  FOR I=1 TO 500
80  ENTER 701:X
90  ENTER 701:Y
100 DRAW (X-512)/500,(Y-512)/500
110 PEN 1
120 NEXT I
130 END

```

Figure 9-31, 32, 33 show plotting examples of Smith chart, Enlarged Smith chart, and polar coordinate, respectively.

VSWR	R.COEF	PHASE	IMPEDANCE<NORM.>	L OR C
REF -28.2 dBm		ATT 10 dB	MKR	102.571 MHz
+2.36	+404 m	164°	434 mΩ + j114 mΩ	8.84nH

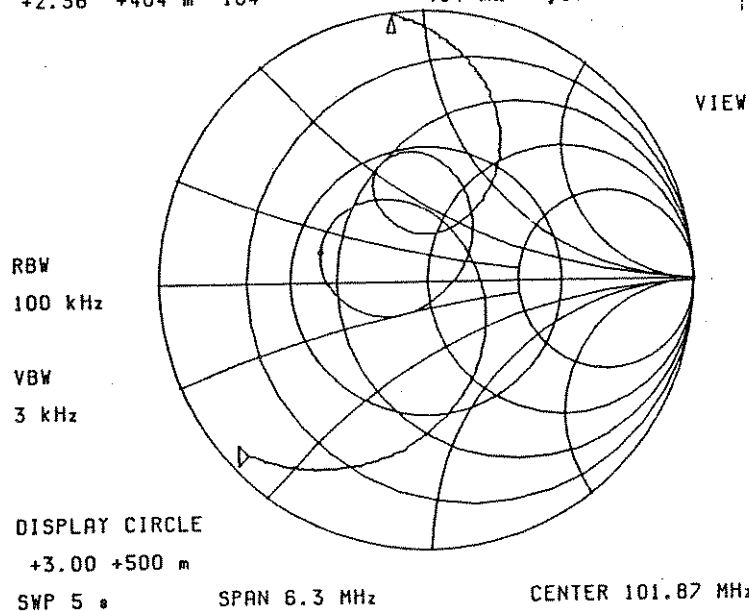

Fig. 9-31 Smith chart plotted

REF -37.7 dBm ATT 10 dB

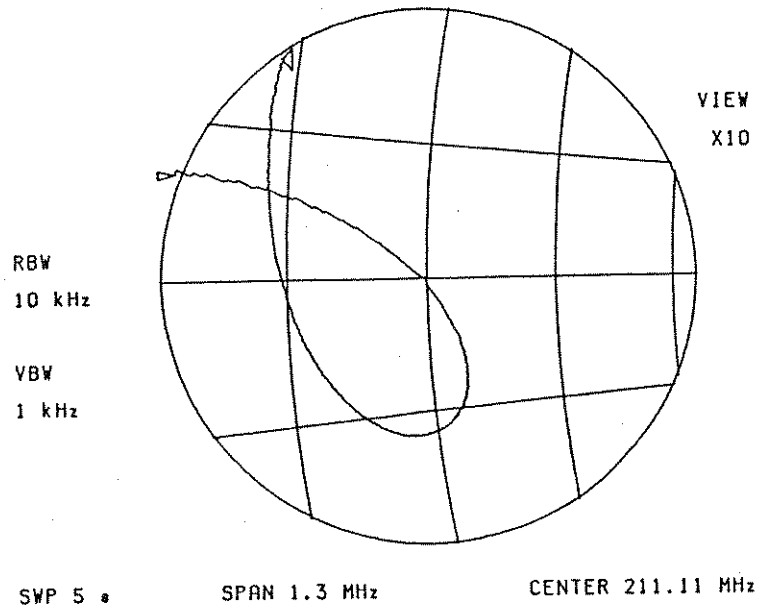

Fig. 9-32 Enlarged Smith chart plotted

REF -27.5 dBm ATT 10 dB

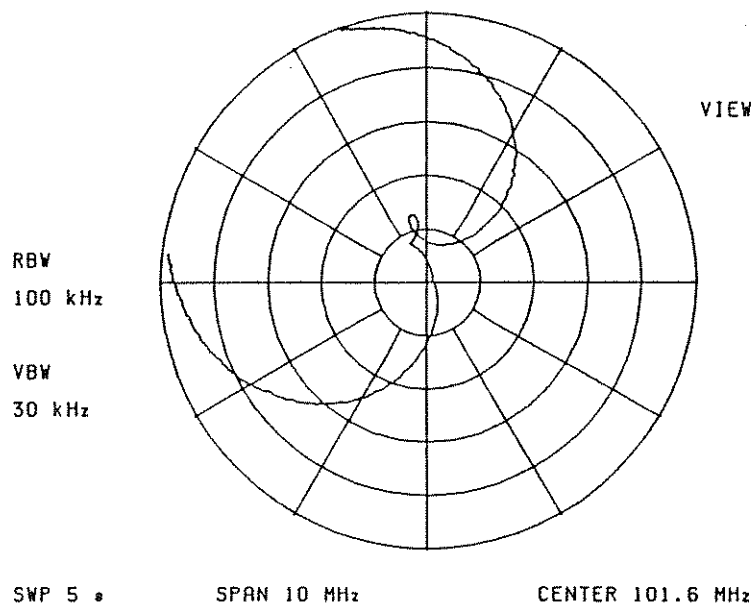

Fig. 9-33 Polar coordinate display plotted

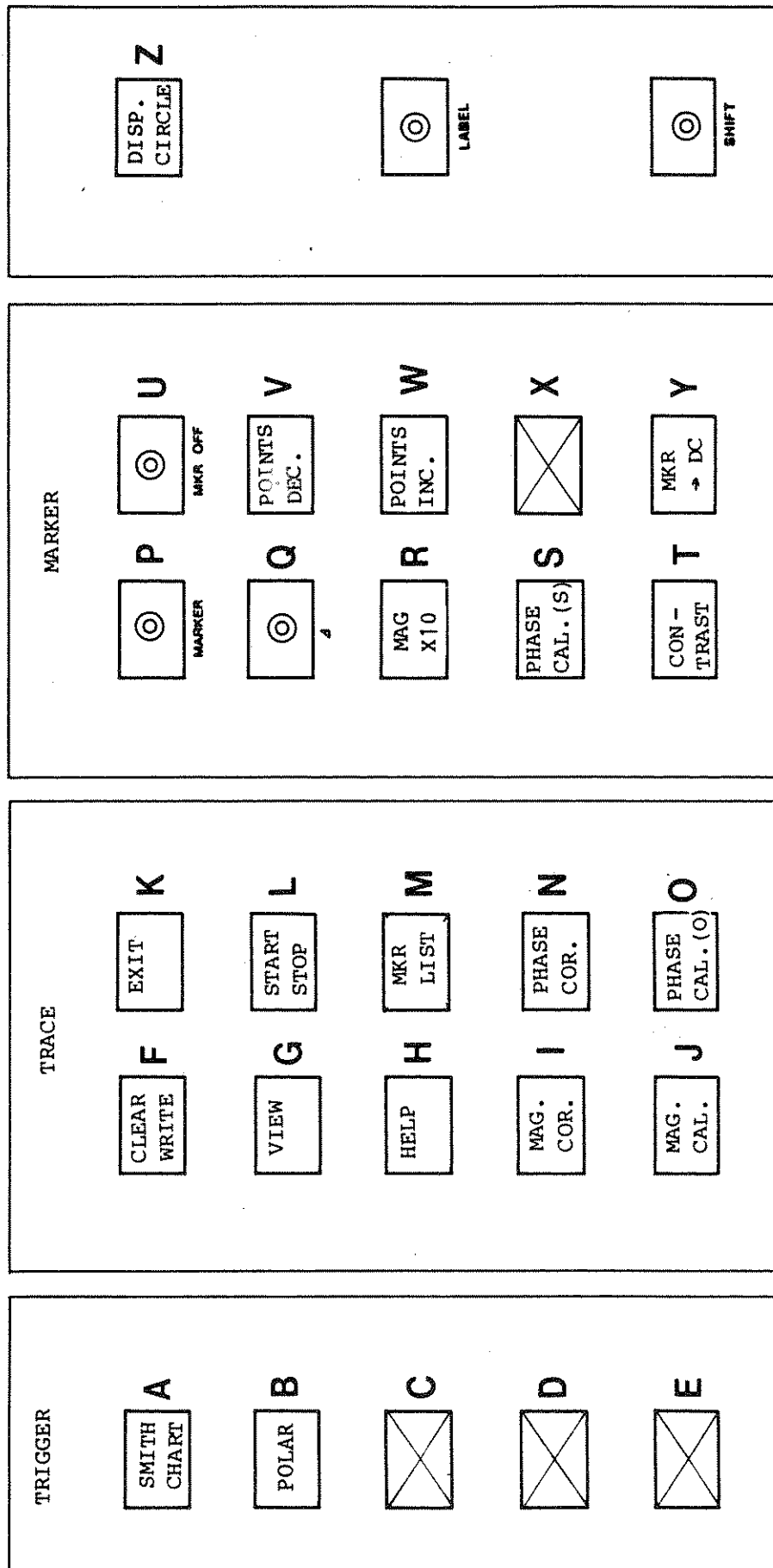

Fig. 9-34 Key functions unique to the impedance measurement mode (Keys marked (X) are not operative. Keys marked (●) have their original functions.)

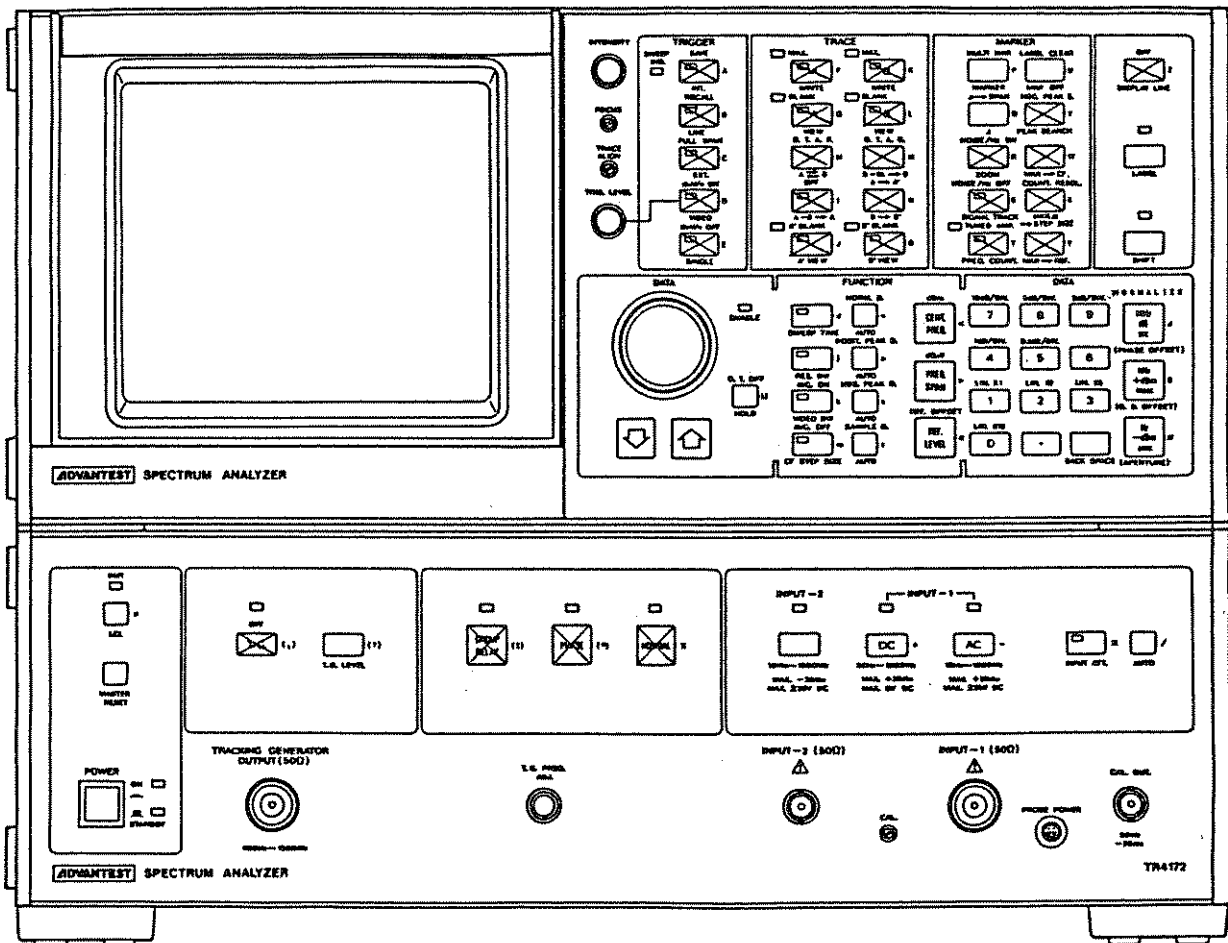



Fig. 9-35 Keys having different functions in the impedance measurement mode. (All keys other than those marked  have their original functions.)